

- ° Profilati in alluminio a disegno/standard/speciali
- ° Dissipatori di calore in barre
- ° Dissipatori di calore ad ALTO RENDIMENTO
- ° Dissipatori di calore per LED
- ° Dissipatori di calore lavorati a disegno e anodizzati
- ° Contenitori porta schede per elettronica in alluminio tipo DIN 43700
- ° Profilati strutturali modulari per robotica
- ° Profilati strutturali modulari per impianti FOTOVOLTAICI

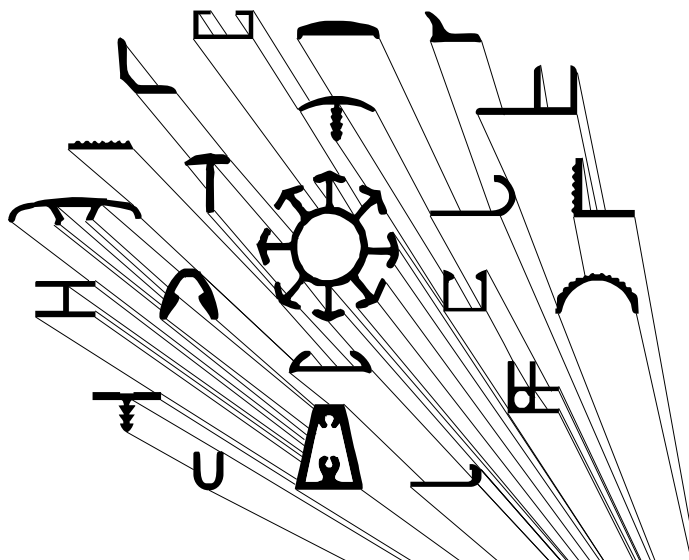

OMAR s.r.l.
**PROFILATI ALLUMINIO
 ALTA TECNOLOGIA**

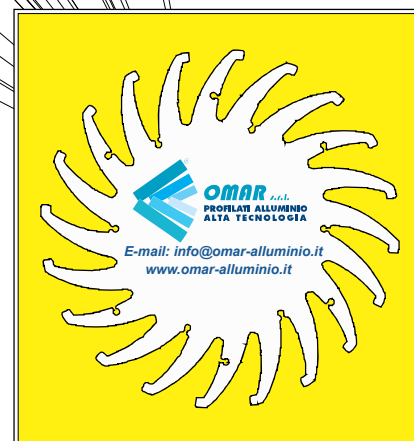

Le "molte forme" della billetta d'alluminio

Edizione Marzo 2023

Consultate il catalogo aggiornato online su:

- www.omar-alluminio.it
- www.omar-alluminio.com
- www.omar-alluminio.eu

- ° Profilati per pneumatica
- ° Profilati per stand
- ° Profilati per battiscopa copri fili zoccolini
- ° Prodotti derivati da profili di alluminio
- ° Lavorazione meccanica profili di alluminio

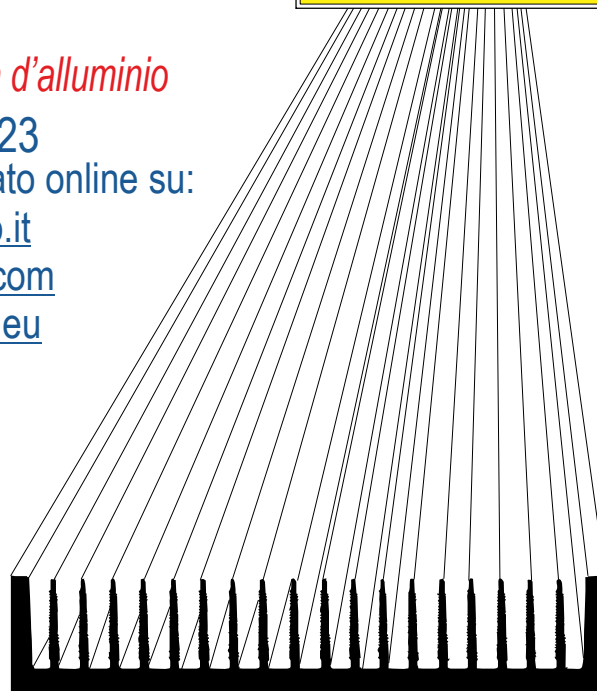

**Via Newton, n.12
 20016 Pero (Milano - Italy)
 Tel.+39 02 3535955 r.a.
 Fax.+39 02 3539929
 E.Mail: info@omar-alluminio.it**

PROFILATI IN ALLUMINIO
 A DISEGNO-STANDARD-SPECIALI



ED: ELETTRONICA-LED-FOTOVOLTAICO
 AUTOMAZIONE ROBOTICA-PNEUMATICA-AUTOMOTIVE

Profili in alluminio per contenitori elettronici tipo DIN 43700

FORI Ø 2,4 per viti autofilettanti
ACCESSORI vedi pag. 122



DISEGNI META' DEL VERO (1:2) - SCALE 1:2

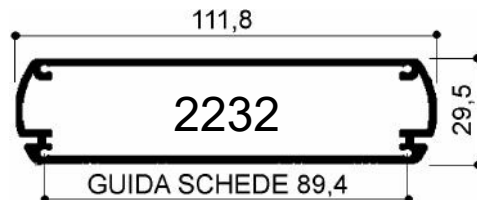
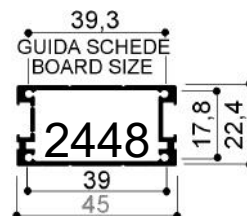
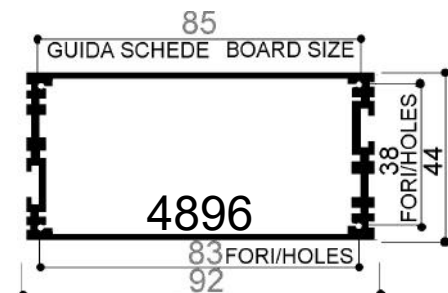
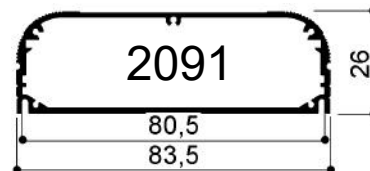
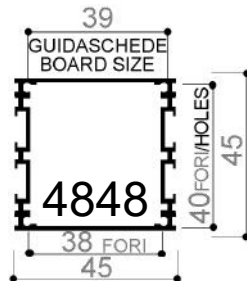
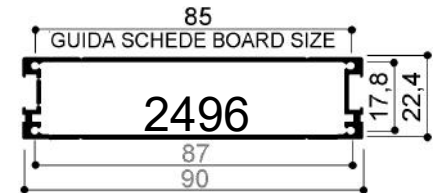
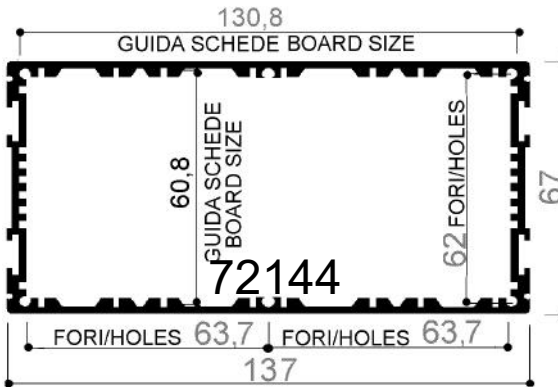
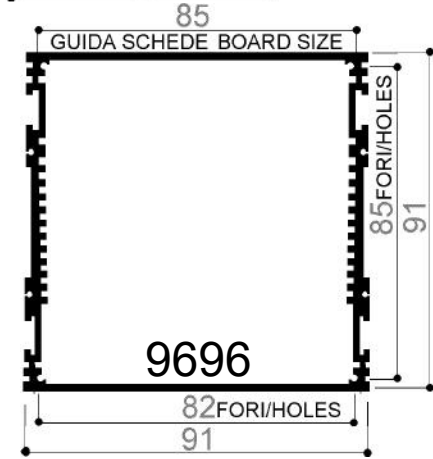
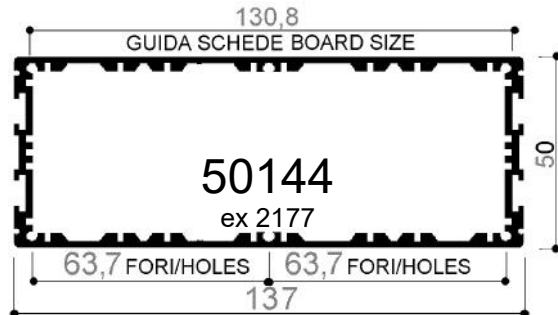
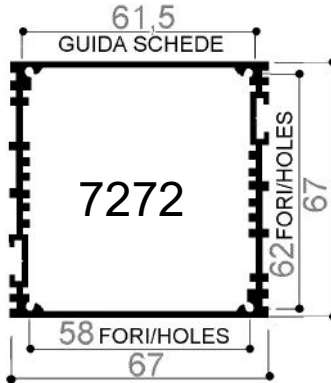
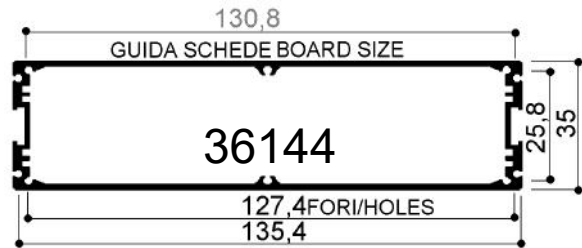
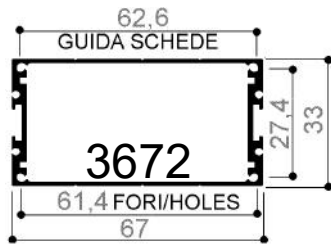
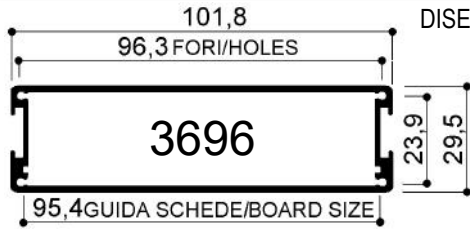

Profili in alluminio per contenitori elettronici tipo DIN 43700

FORI Ø 2,4 per viti autofilettanti -
ACCESSORI vedi pag. 122



DISEGNI META' DEL VERO (1:2)- SCALE 1:2

Via Newton, n. 12
20016 Pero (Milano - Italy)
Tel. +39 02 3535955 r.a. Fax. +39 02 3539929
E. Mail: info@omar-alluminio.it

Cataloghi Online: www.omar-alluminio.it

www.omar-alluminio.com

PROFILATI ALLUMINIO A DISEGNO / STANDARD / SPECIALI / E PER:
ELETTRONICA / LED / FOTOVOLTAICO / AUTOMAZIONE ROBOTICA / PNEUMATICA / AUTOMOTIVE

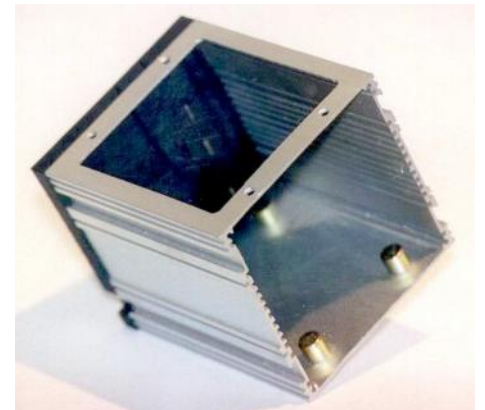
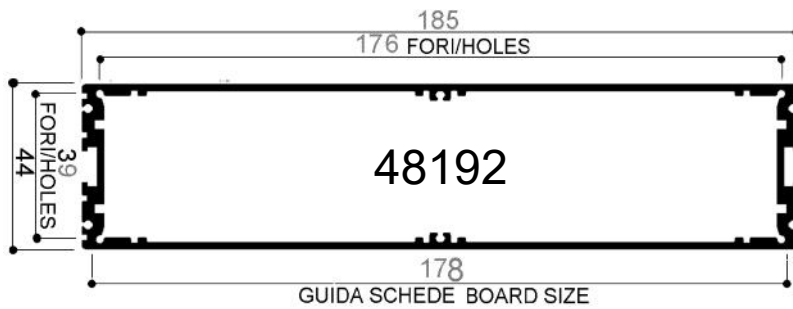
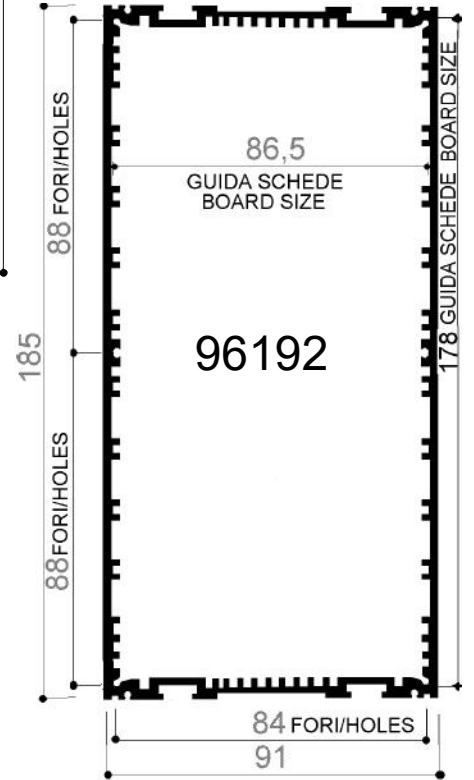
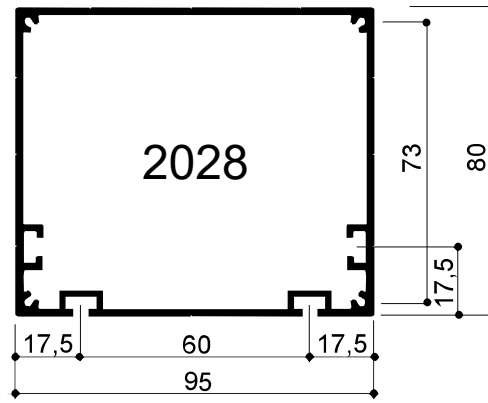
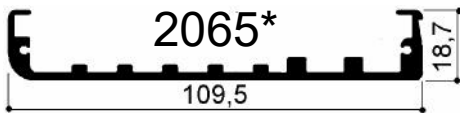
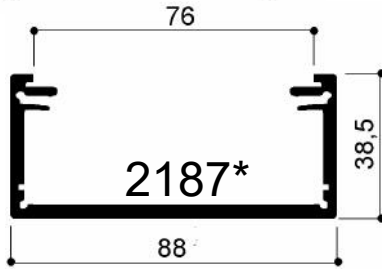
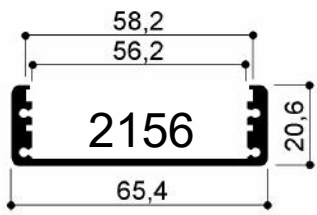
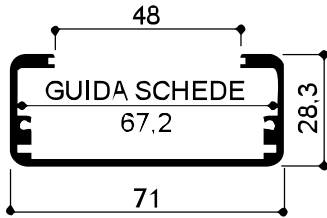

Profili in alluminio per contenitori elettronici tipo DIN 43700

FORI Ø 2,4 per viti autofilettanti -
ACCESSORI vedi pag.122



DISEGNI META' DEL VERO (1:2)- SCALE 1:2

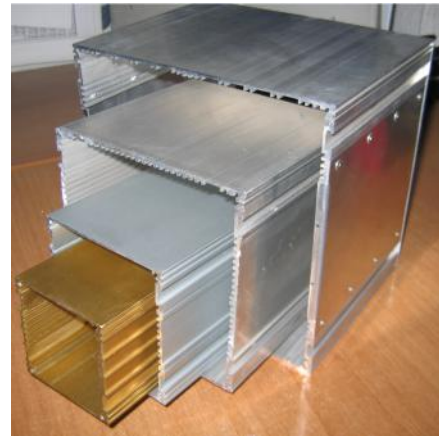
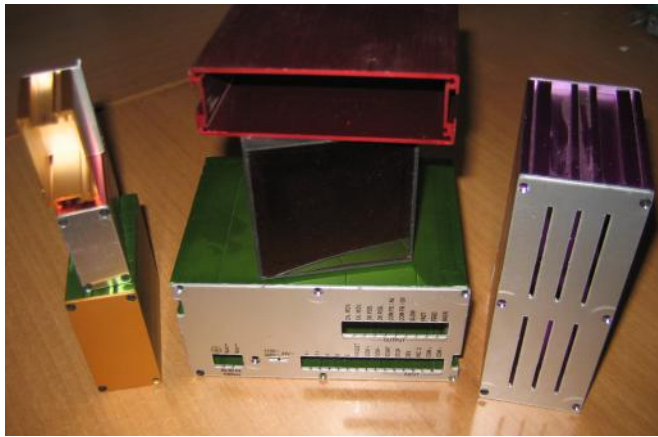
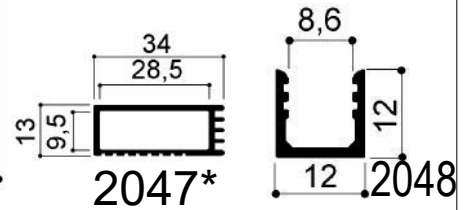
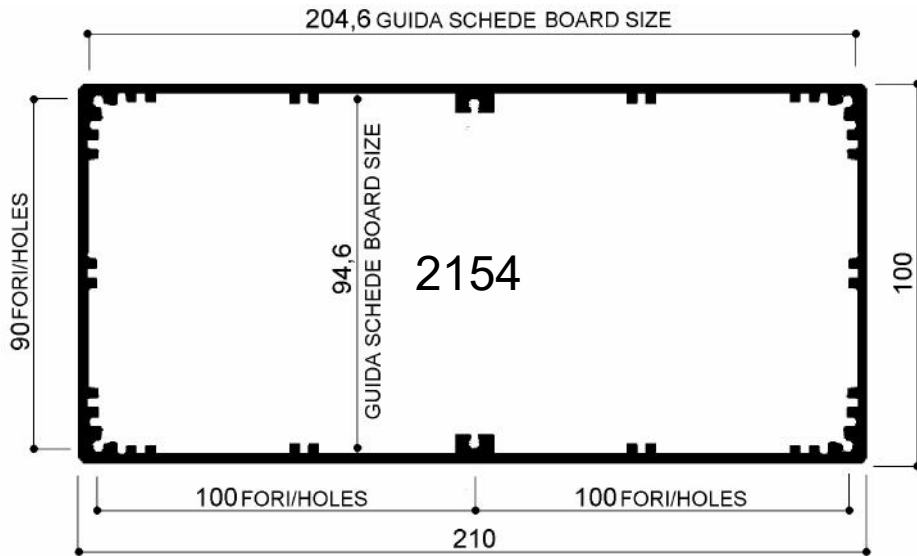
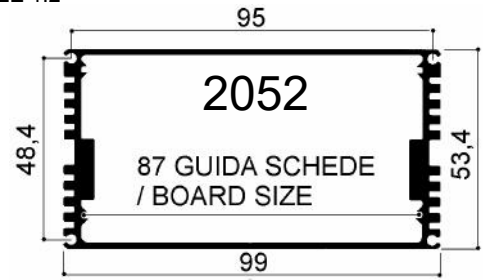
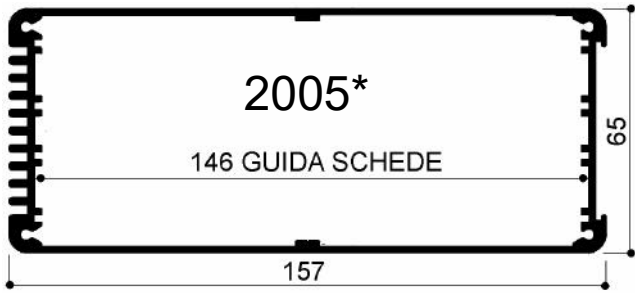

Profili per insegne luminose - passanti

DISEGNI META' DEL VERO (1:2)- SCALE 1:2
A STOCK IN BARRE OSSIDATO ARGENTO

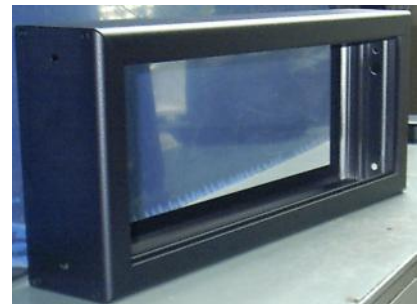
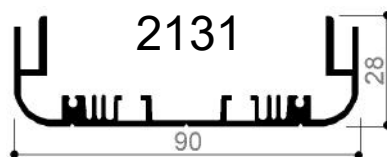

Via Newton, n.12

20016 Pero (Milano - Italy)

Tel. +39 02 3535955 r.a. Fax. +39 02 3539929

E-Mail: info@omar-alluminio.it

Cataloghi Online: www.omar-alluminio.it

www.omar-alluminio.com

PROFILATI ALLUMINIO A DISEGNO / STANDARD / SPECIALI / E PER:
ELETTRONICA / LED / FOTOVOLTAICO / AUTOMAZIONE ROBOTICA / PNEUMATICA / AUTOMOTIVE

DISEGNI META' DEL VERO (1:2)- SCALE 1:2

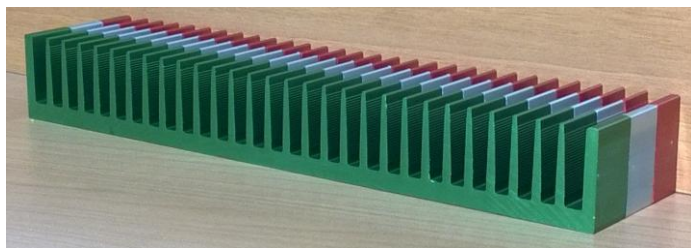
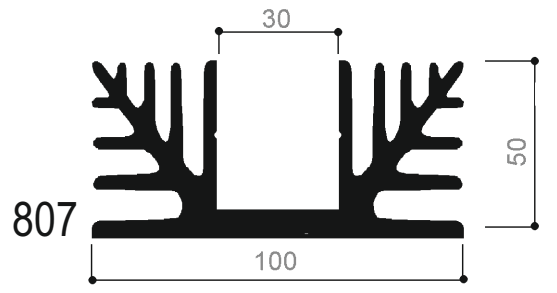
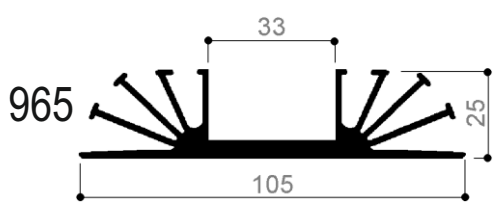
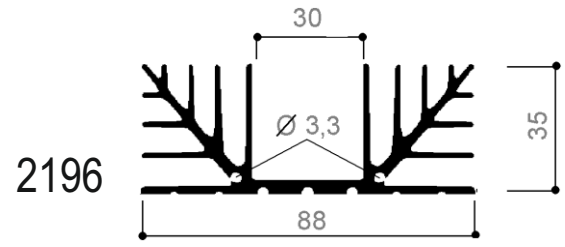
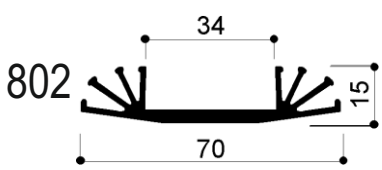
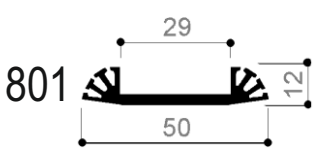
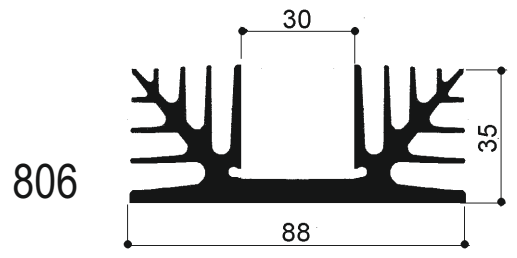
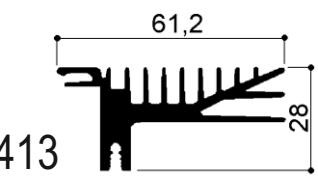
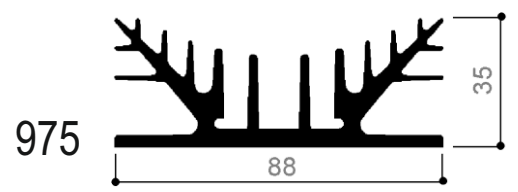
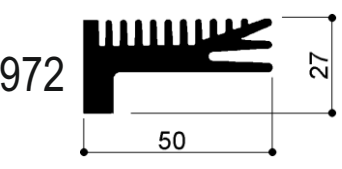
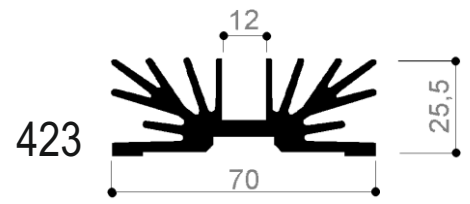
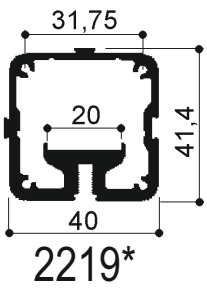
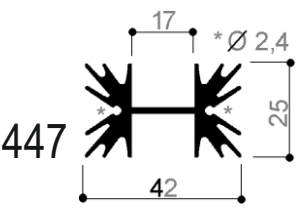
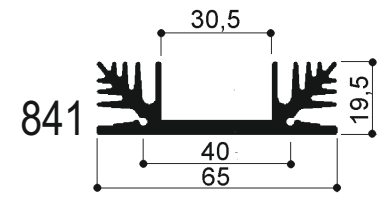
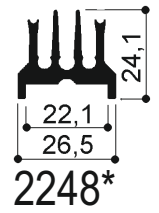
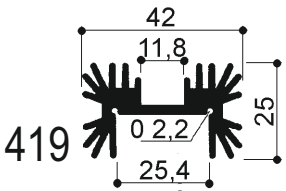
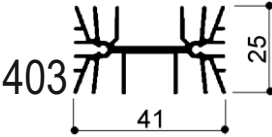
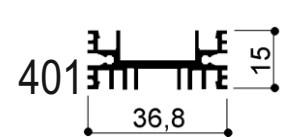
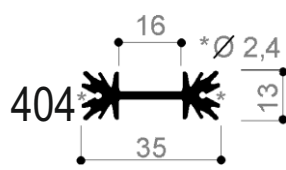
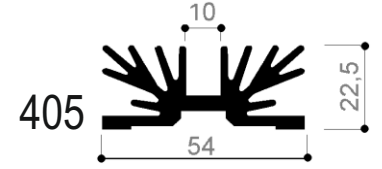
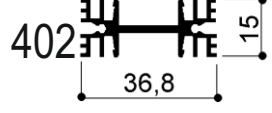
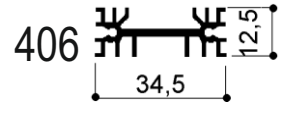
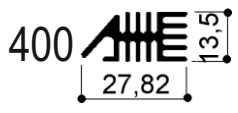

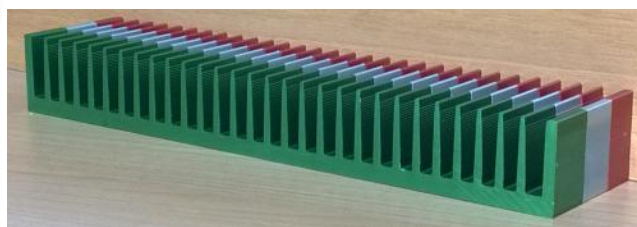
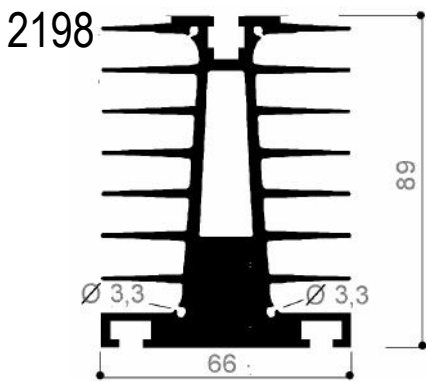
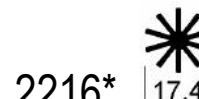
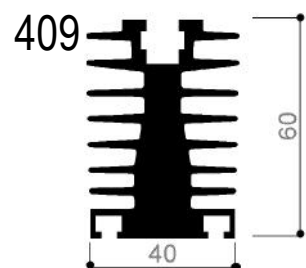
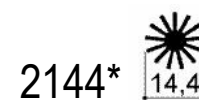
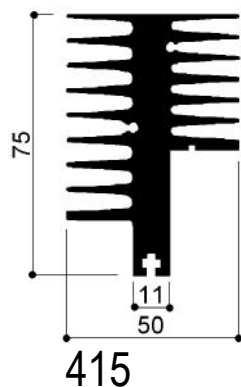
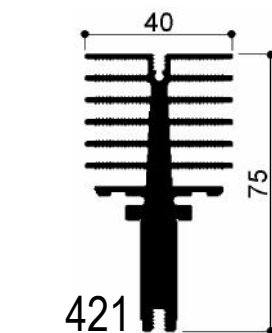
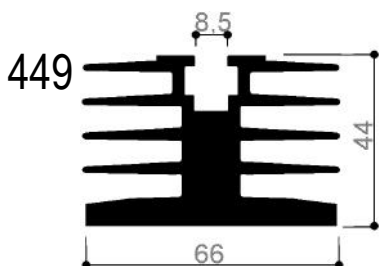
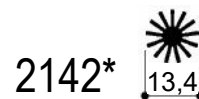
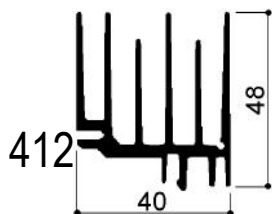
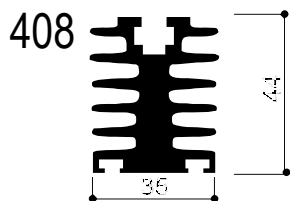
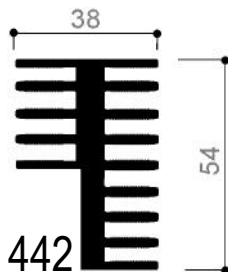
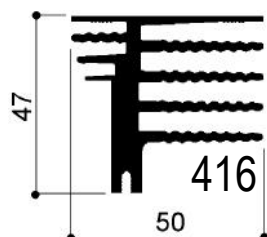
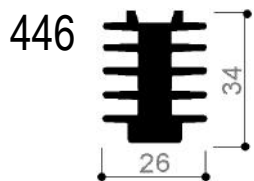

PER ULTERIORI SEZIONI CONSULTARE IL SITO
WWW.DISSIPATORI.COM

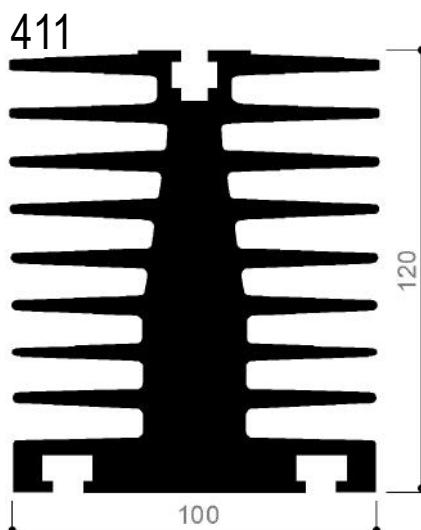
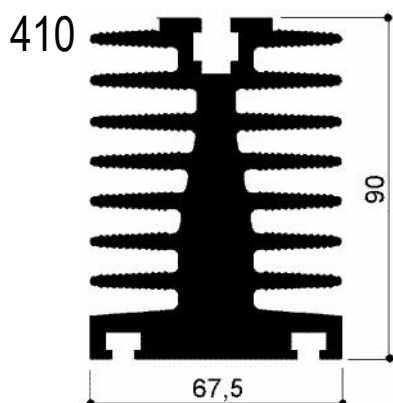
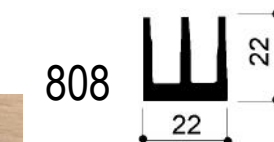
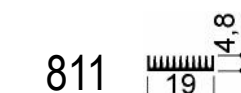

Via Newton, n.12
 20016 Pero (Milano - Italy)
 Tel. +39 02 3535955 r.a. Fax. +39 02 3539929
 E-Mail: info@omar-alluminio.it

Cataloghi Online: www.omar-alluminio.it
 www.omar-alluminio.com

PROFILATI ALLUMINIO A DISEGNO / STANDARD / SPECIALI / E PER:
 ELETTRONICA / LED / FOTOVOLTAICO / AUTOMAZIONE ROBOTICA / PNEUMATICA / AUTOMOTIVE



FOTO DI ESEMPIO: SI ESEGUONO LAVORAZIONI MECCANICHE SU PROFILI ESTRUSI IN ALLUMINIO





FOTO DI ESEMPIO: DISSIPATORI A DOPPIO
PETTINE DI GRANDI DIMENSIONI
(mm 300 x 65mm kg/mt 16 circa)

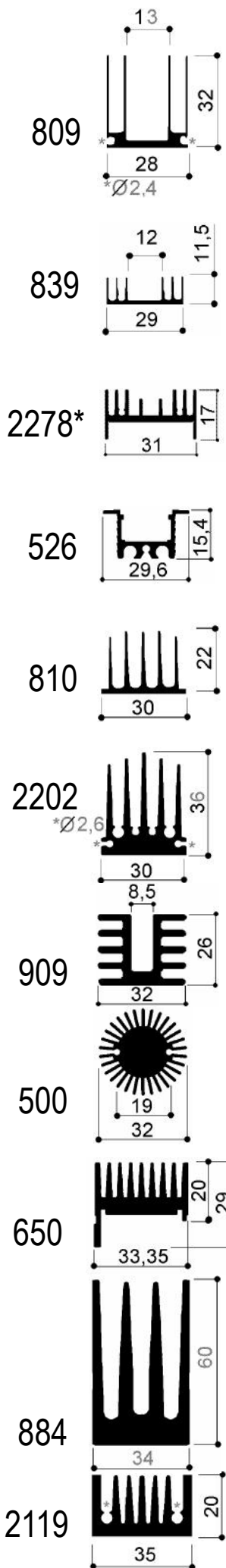
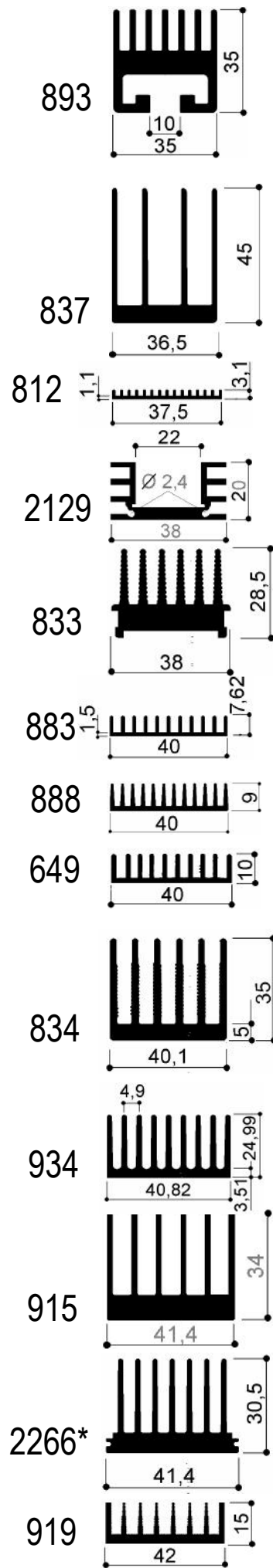

Via Newton, n.12
20016 Pero (Milano - Italy)
Tel. +39 02 3535955 r.a. Fax. +39 02 3539929
E-Mail: info@omar-alluminio.it

Cataloghi Online: www.omar-alluminio.it
www.omar-alluminio.com

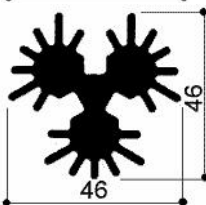
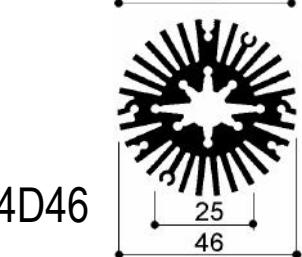
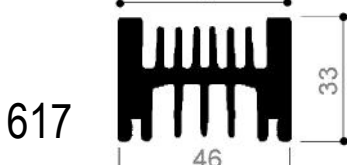
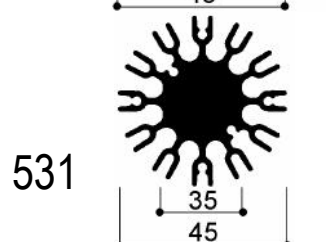
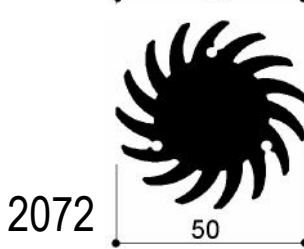
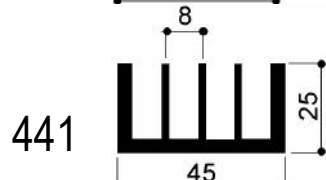
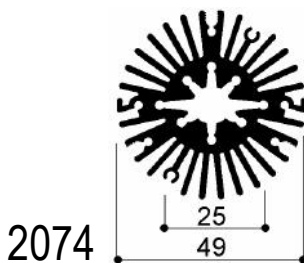
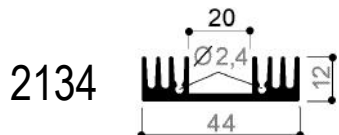
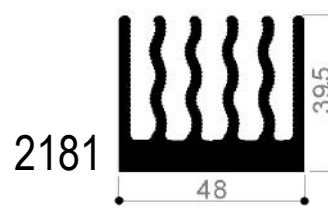
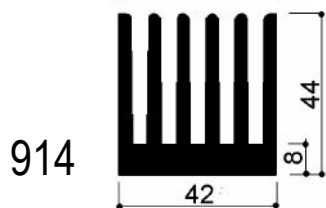
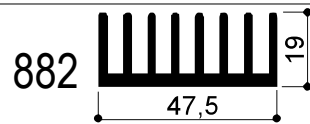
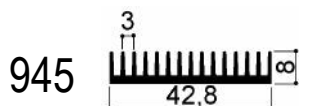
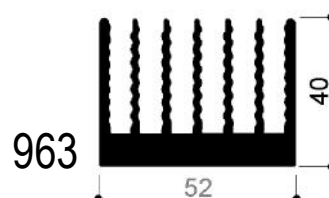
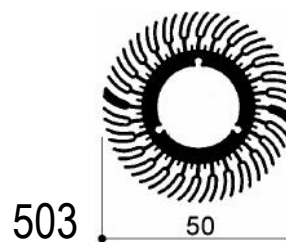
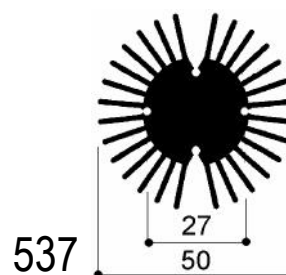
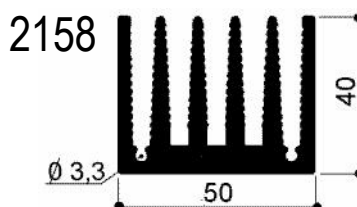
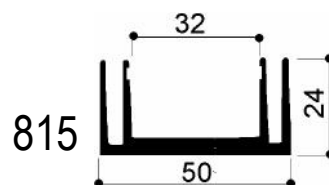
PROFILATI ALLUMINIO A DISEGNO / STANDARD / SPECIALI / E PER:
ELETTRONICA / LED / FOTOVOLTAICO / AUTOMAZIONE ROBOTICA / PNEUMATICA / AUTOMOTIVE

*PROFILO RISERVATO



DISEGNI META' DEL VERO (1:2) - SCALE 1:2

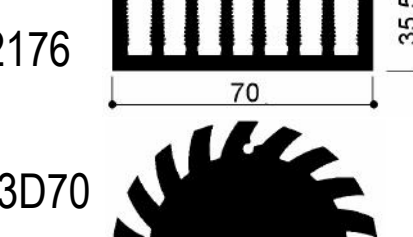
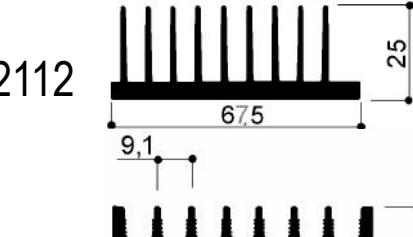
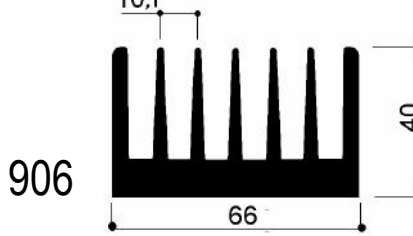
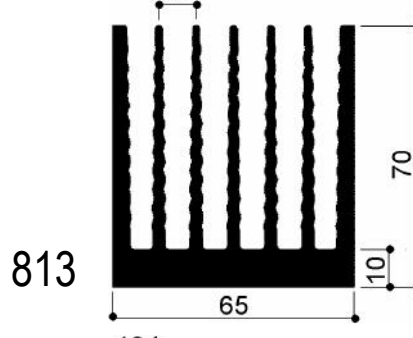
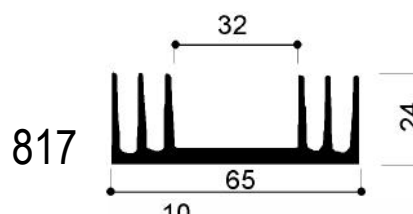
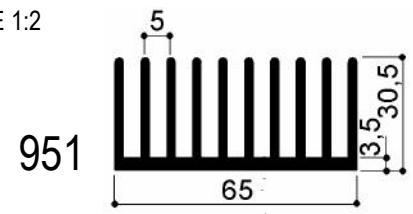
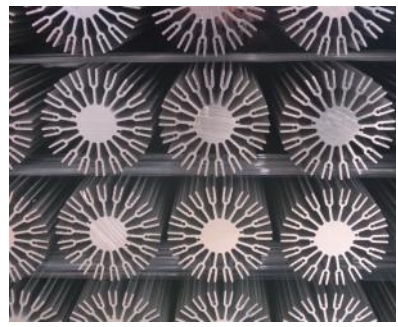
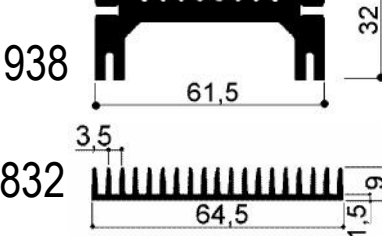
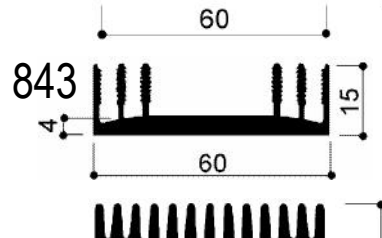
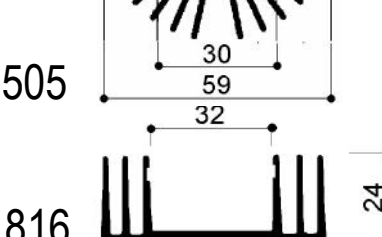
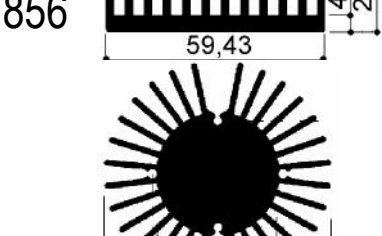
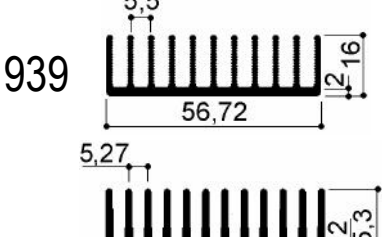
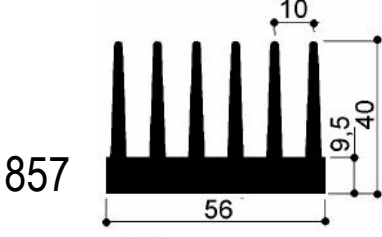
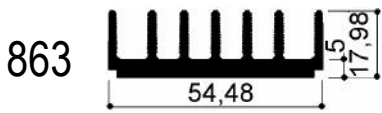
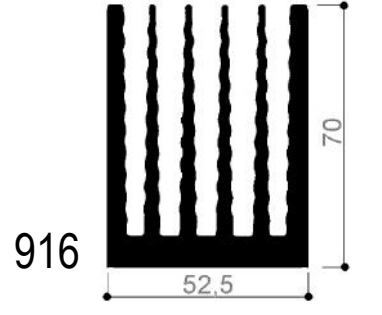
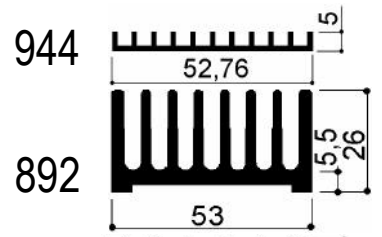

2073D70

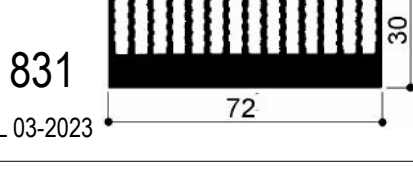
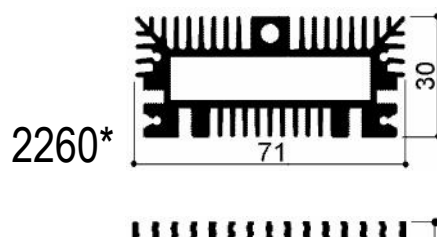
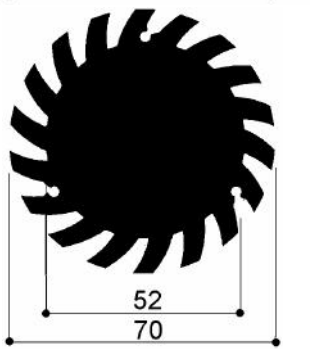

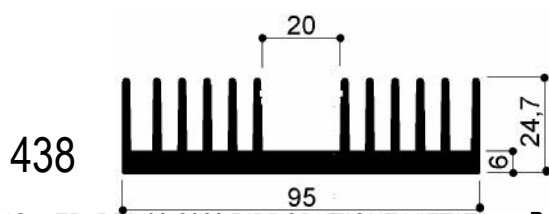
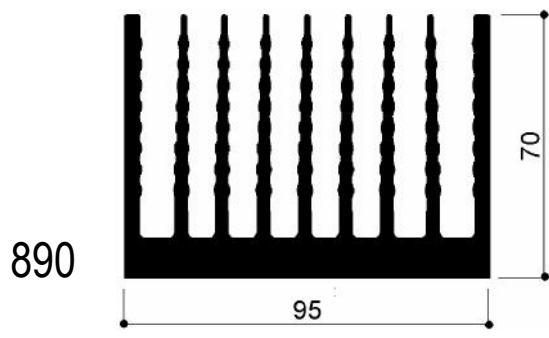
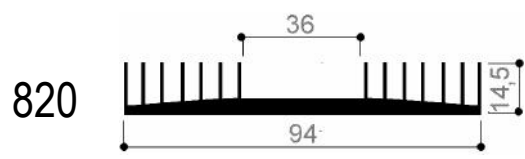
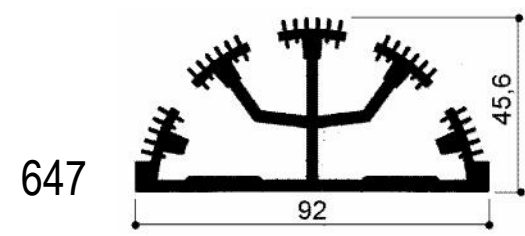
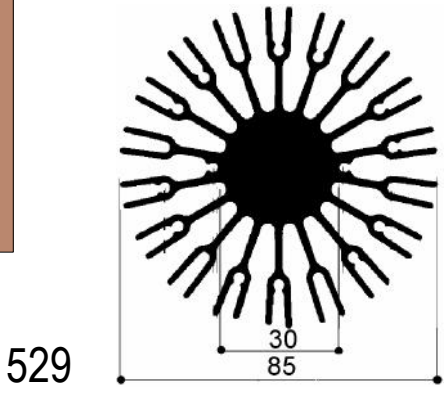
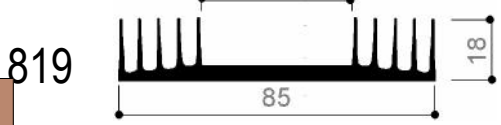
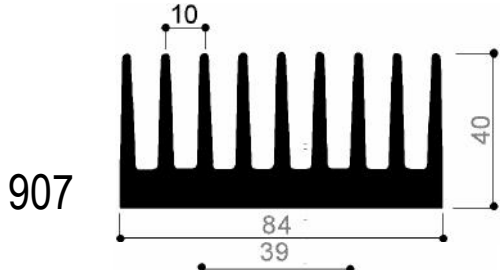
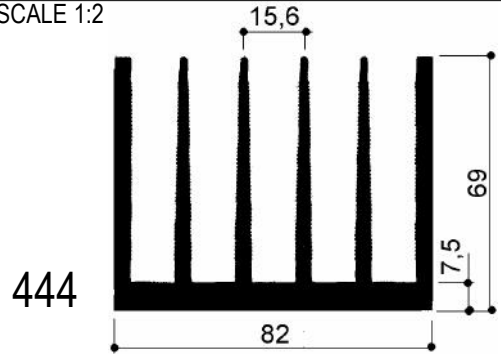
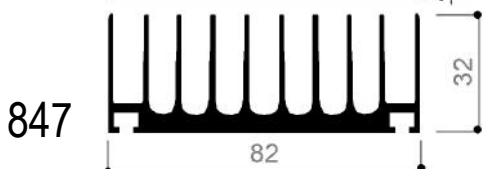
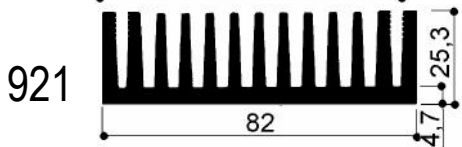
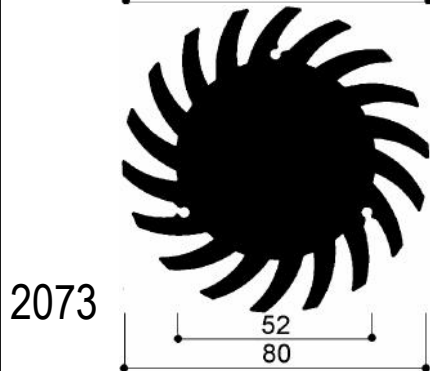
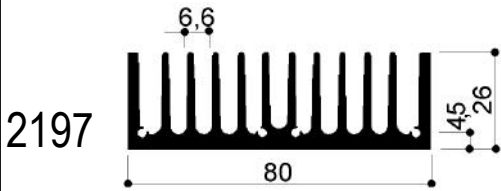
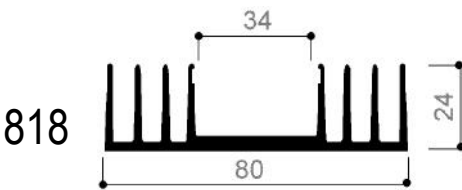
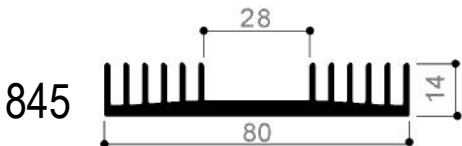
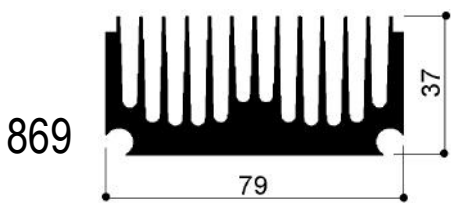
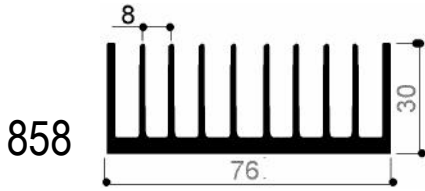
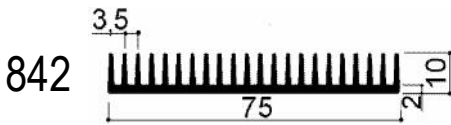
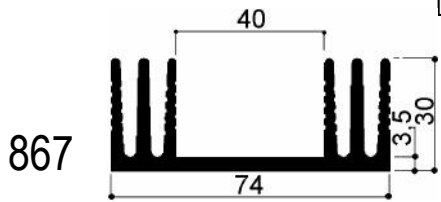

Via Newton, n.12
20016 Pero (Milano - Italy)
Tel. +39 02 3535955 r.a. Fax. +39 02 3539929
E-Mail: info@omar-alluminio.it

Cataloghi Online: www.omar-alluminio.it
www.omar-alluminio.com

PROFILATI ALLUMINIO A DISEGNO / STANDARD / SPECIALI / E PER:
ELETTRONICA / LED / FOTOVOLTAICO / AUTOMAZIONE ROBOTICA / PNEUMATICA / AUTOMOTIVE



Via Newton, n.12
 20016 Pero (Milano - Italy)
 Tel. +39 02 3535955 r.a. Fax. +39 02 3539929
 E. Mail: info@omar-alluminio.it

Cataloghi Online: www.omar-alluminio.it
 www.omar-alluminio.com

PROFILATI ALLUMINIO A DISEGNO / STANDARD / SPECIALI / E PER:
 ELETTRONICA / LED / FOTOVOLTAICO / AUTOMAZIONE ROBOTICA / PNEUMATICA / AUTOMOTIVE

OMAR s.r.l.
 PROFILATI ALLUMINIO
 ALTA TECNOLOGIA

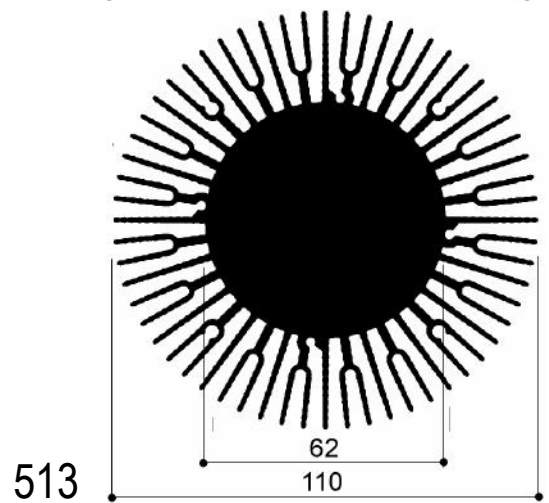
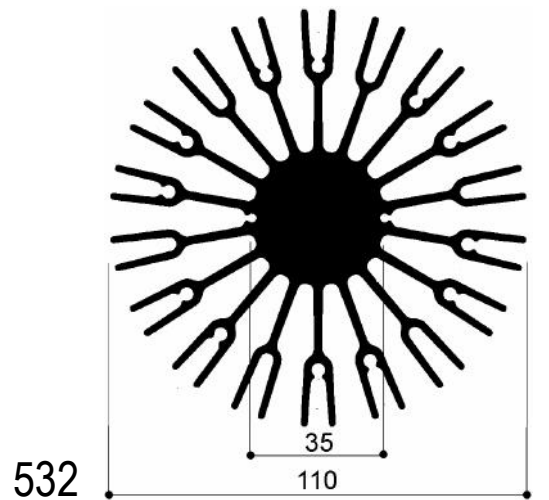
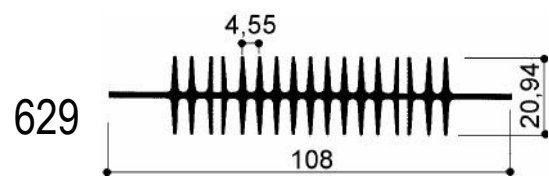
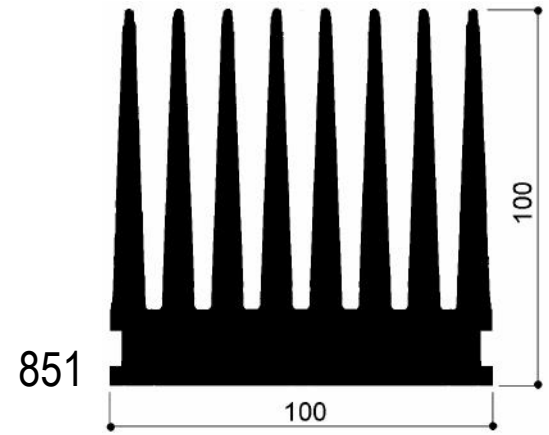
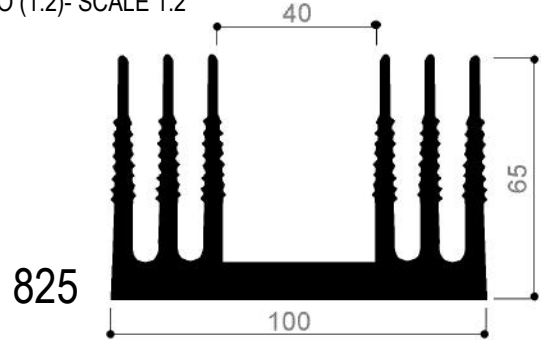
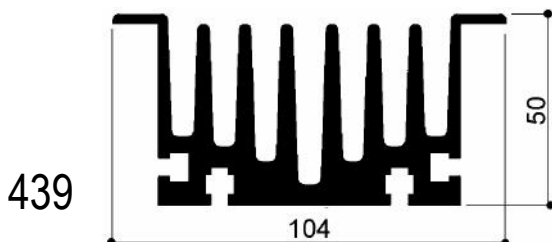
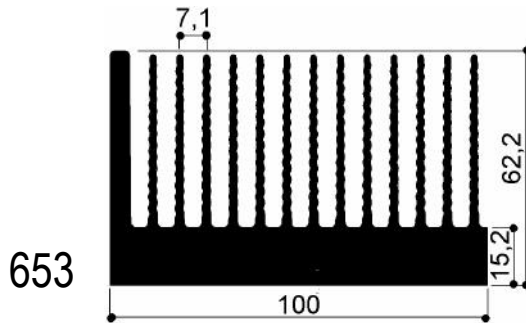
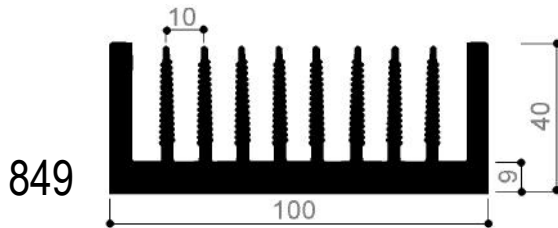
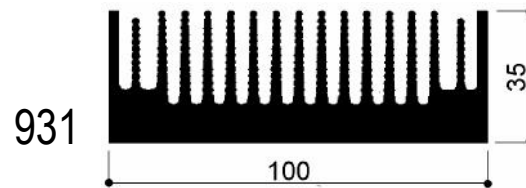
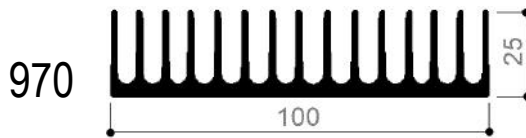
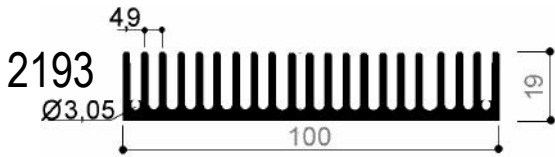
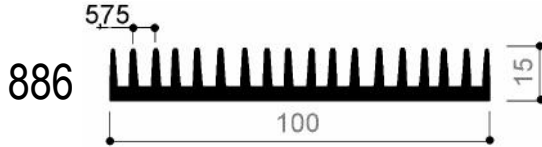
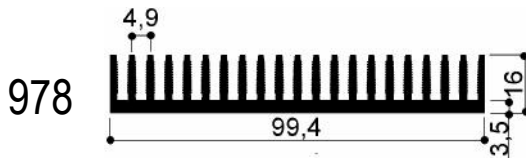
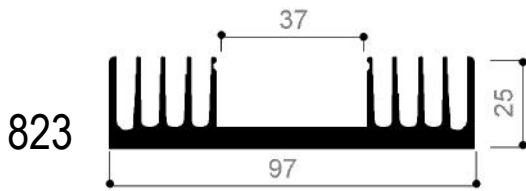

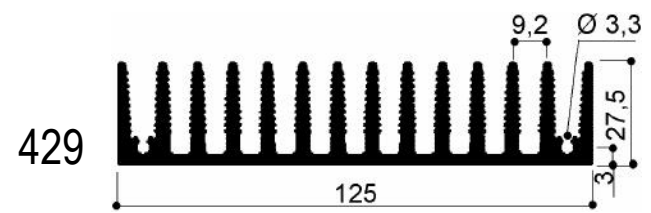
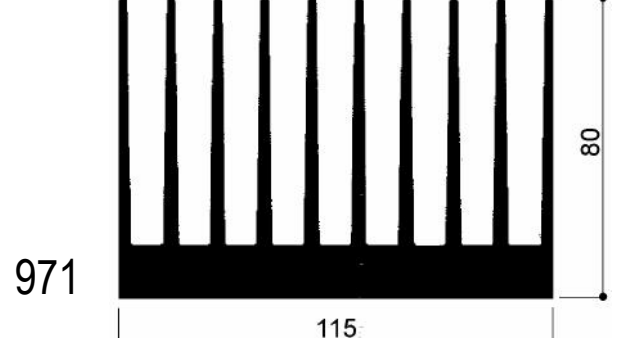
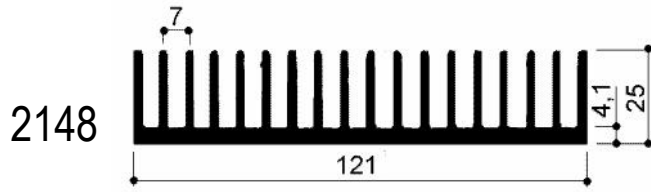
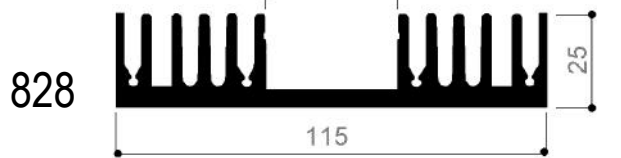
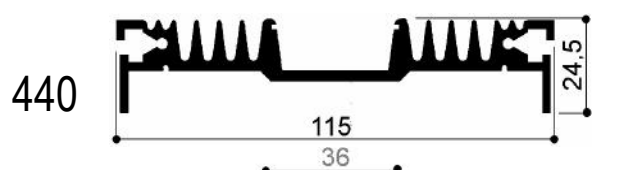
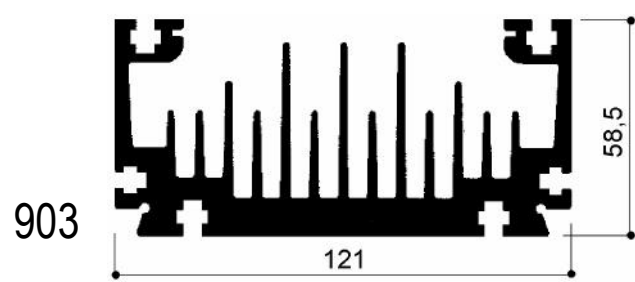
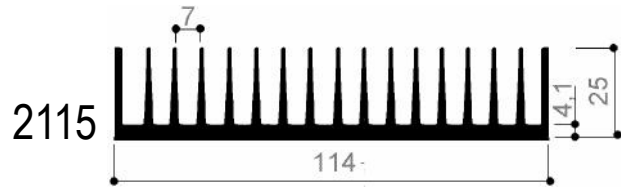
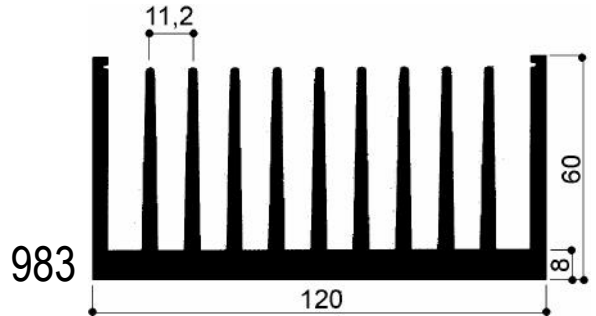
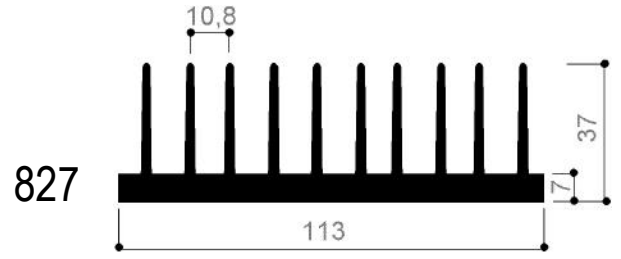
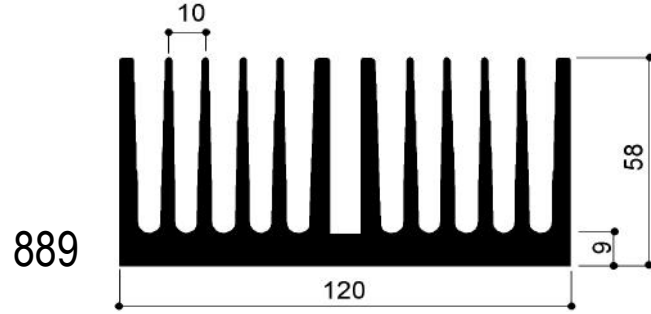
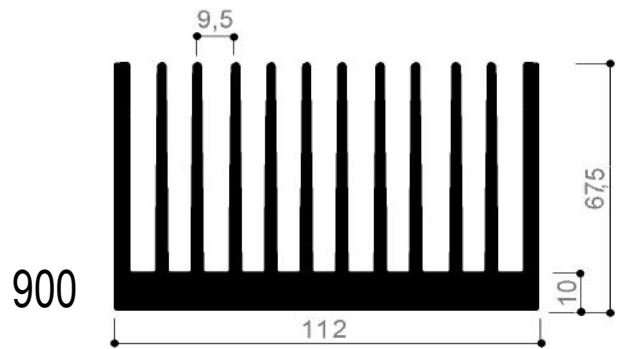
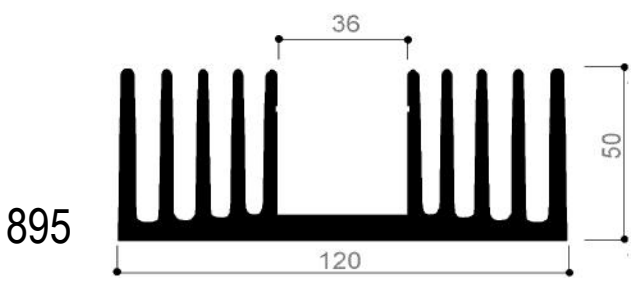
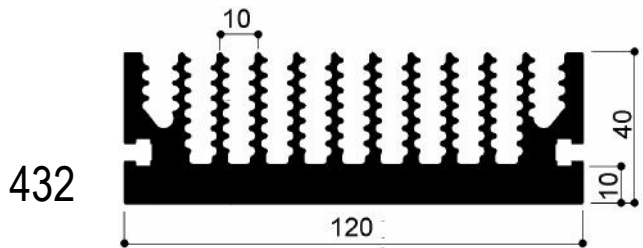
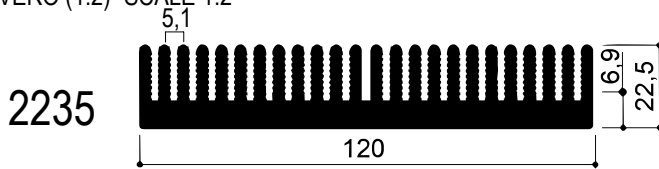
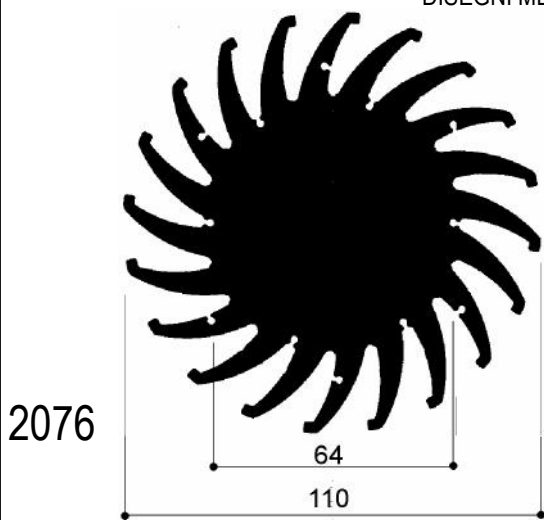

Via Newton, n.12
 20016 Pero (Milano - Italy)
 Tel. +39 02 3535955 r.a. Fax. +39 02 3539929
 E-Mail: info@omar-alluminio.it

Cataloghi Online: www.omar-alluminio.it
www.omar-alluminio.com
 PROFILATI ALLUMINIO A DISEGNO / STANDARD / SPECIALI / E PER:
 ELETTRONICA / LED / FOTOVOLTAICO / AUTOMAZIONE ROBOTICA / PNEUMATICA / AUTOMOTIVE



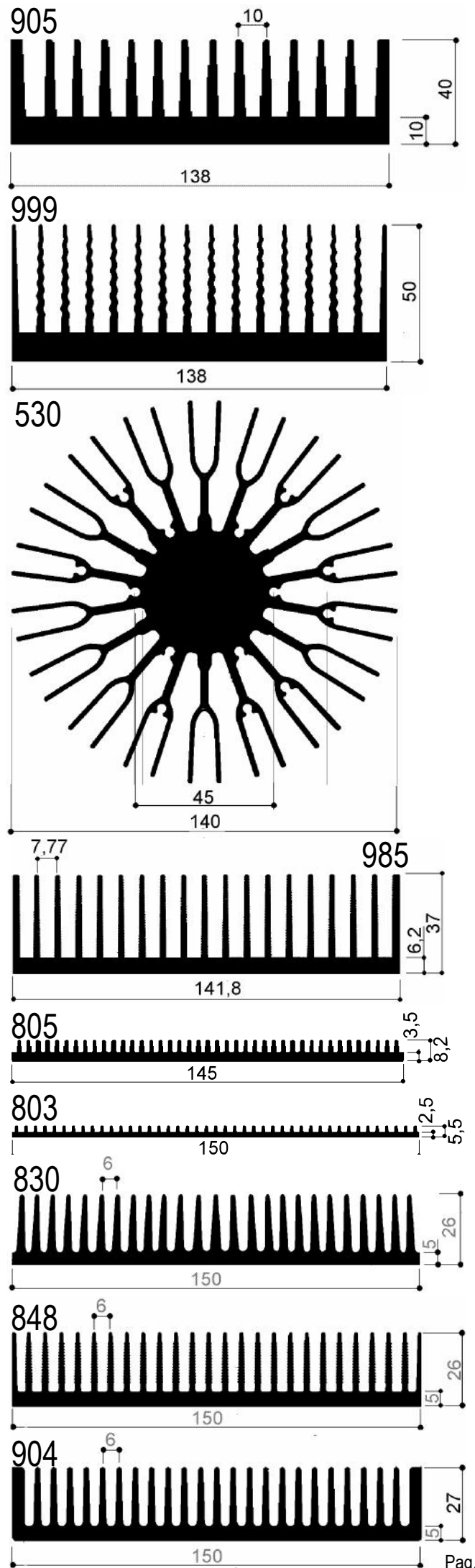
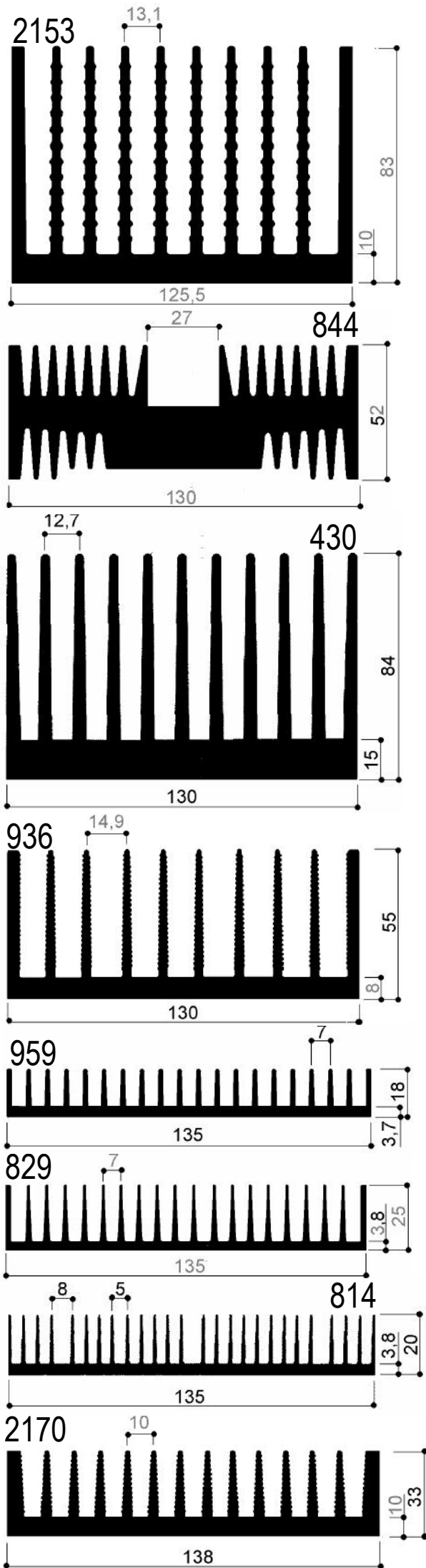

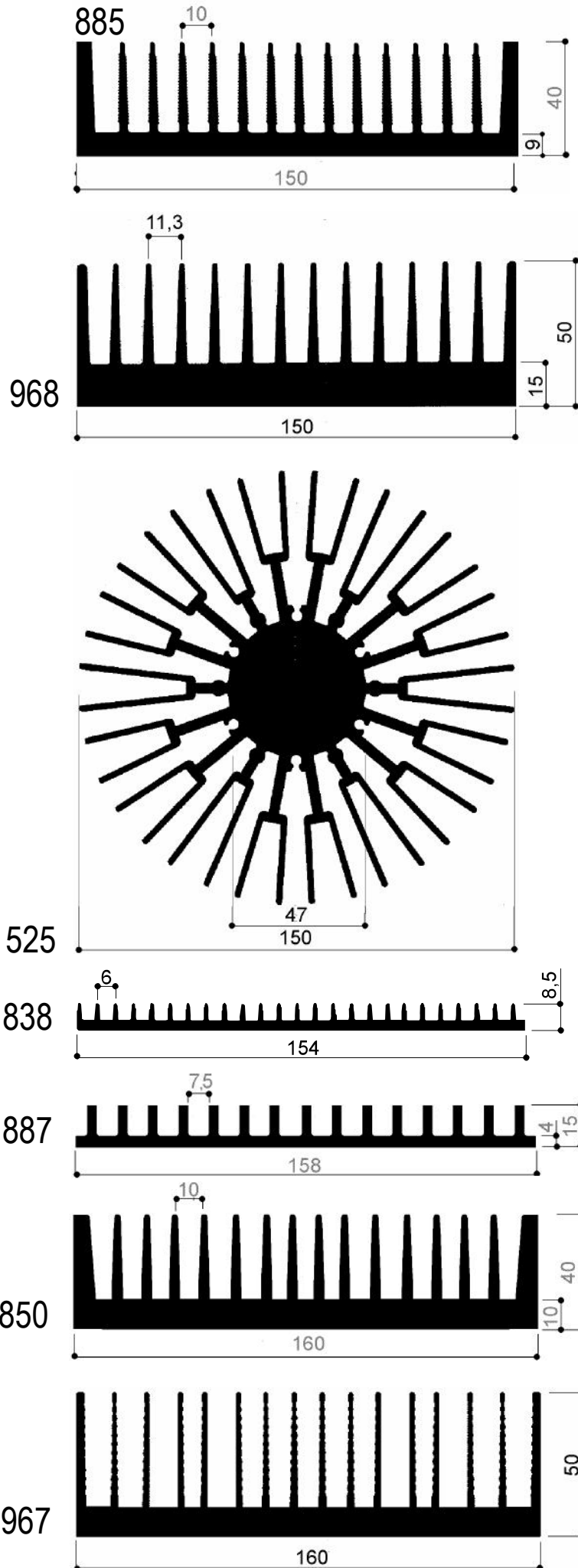

Cataloghi Online: www.omar-alluminio.it

www.omar-alluminio.com

PROFILATI ALLUMINIO A DISEGNO / STANDARD / SPECIALI / E PER:

ELETTRONICA / LED / FOTOVOLTAICO / AUTOMAZIONE ROBOTICA / PNEUMATICA / AUTOMOTIVE



Via Newton, n.12

20016 Pero (Milano - Italy)

Tel. +39 02 3535955 r.a. Fax. +39 02 3539929

E-Mail: info@omar-alluminio.it

Via Newton, n.12
 20016 Pero (Milano - Italy)
 Tel. +39 02 3535955 r.a. Fax. +39 02 3539929
 E-Mail: info@omar-alluminio.it

Cataloghi Online: www.omar-alluminio.it
 www.omar-alluminio.com

PROFILATI ALLUMINIO A DISEGNO / STANDARD / SPECIALI / E PER:
 ELETTRONICA / LED / FOTOVOLTAICO / AUTOMAZIONE ROBOTICA / PNEUMATICA / AUTOMOTIVE

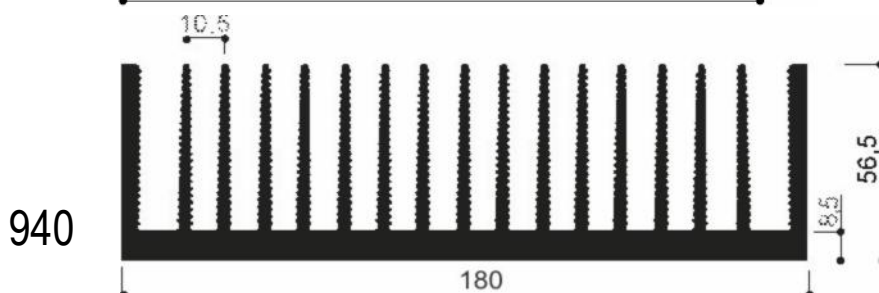
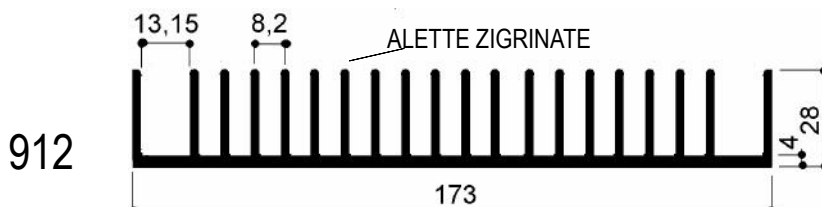
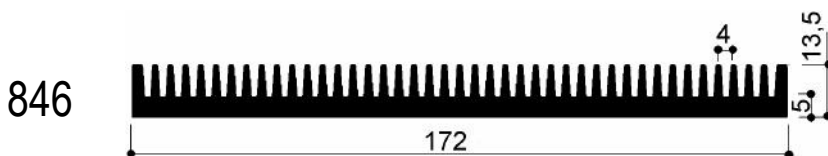
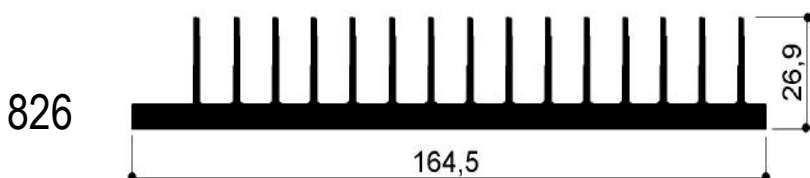
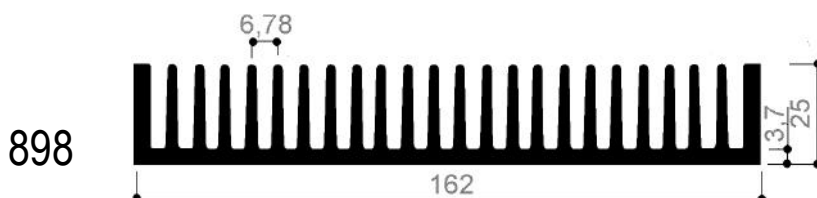
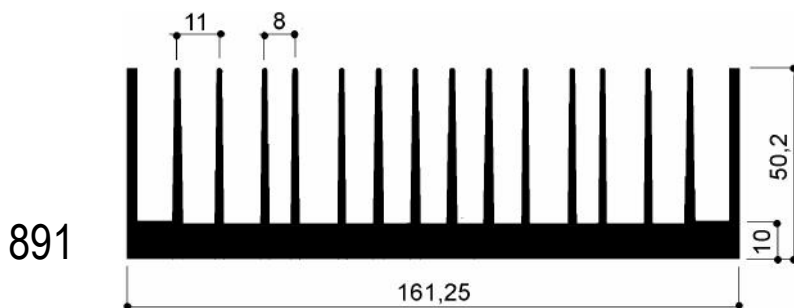
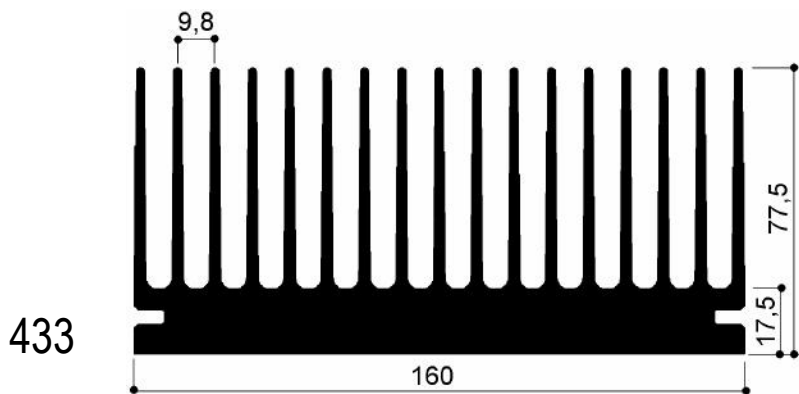

DISEGNI META' DEL VERO (1:2)- SCALE 1:2

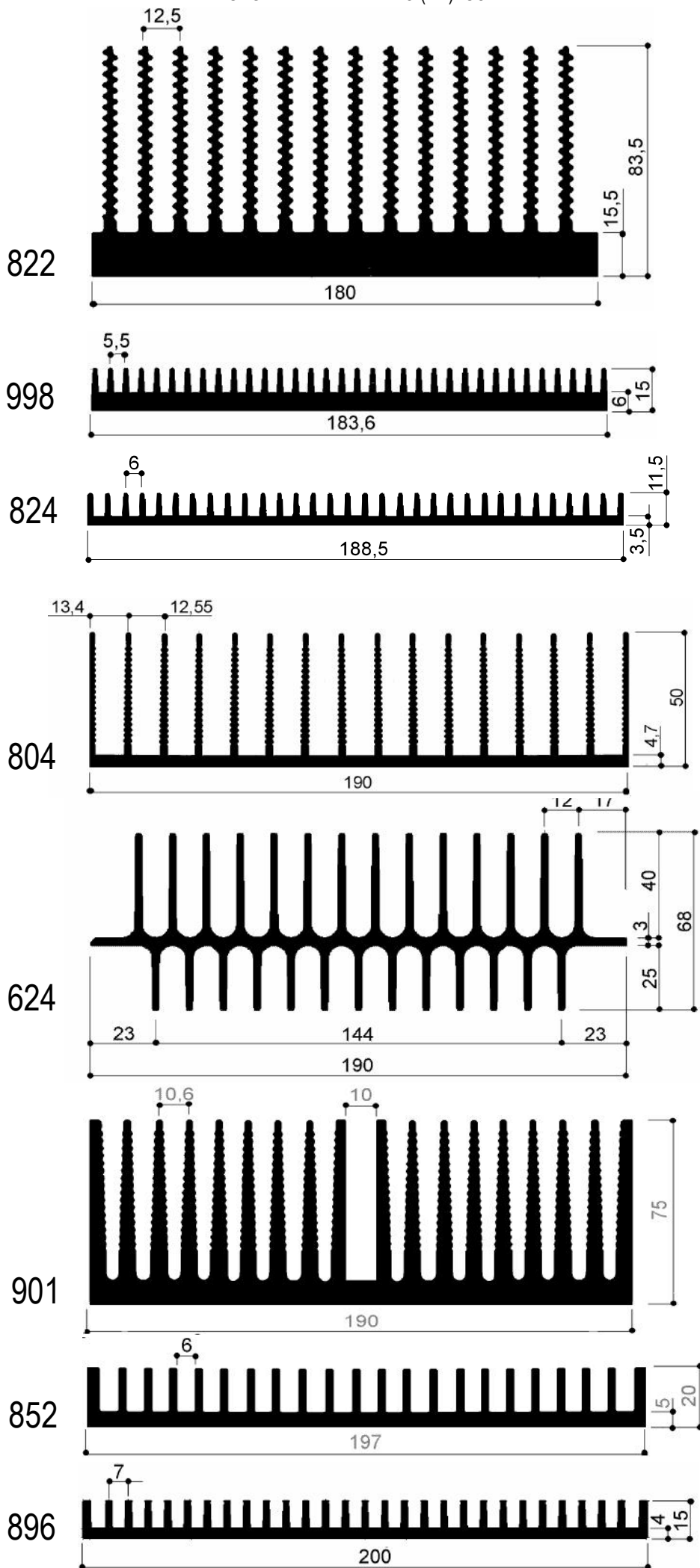

Via Newton, n.12
 20016 Pero (Milano - Italy)
 Tel. +39 02 3535955 r.a. Fax. +39 02 3539929
 E-Mail: info@omar-alluminio.it

Cataloghi Online: www.omar-alluminio.it

www.omar-alluminio.com

PROFILATI ALLUMINIO A DISEGNO / STANDARD / SPECIALI / E PER:

ELETTRONICA / LED / FOTOVOLTAICO / AUTOMAZIONE ROBOTICA / PNEUMATICA / AUTOMOTIVE



Via Newton, n.12
 20016 Pero (Milano - Italy)
 Tel. +39 02 3535955 r.a. Fax. +39 02 3539929
 E. Mail: info@omar-alluminio.it

Cataloghi Online: www.omar-alluminio.it
www.omar-alluminio.com

PROFILATI ALLUMINIO A DISEGNO / STANDARD / SPECIALI / E PER:
 ELETTRONICA / LED / FOTOVOLTAICO / AUTOMAZIONE ROBOTICA / PNEUMATICA / AUTOMOTIVE

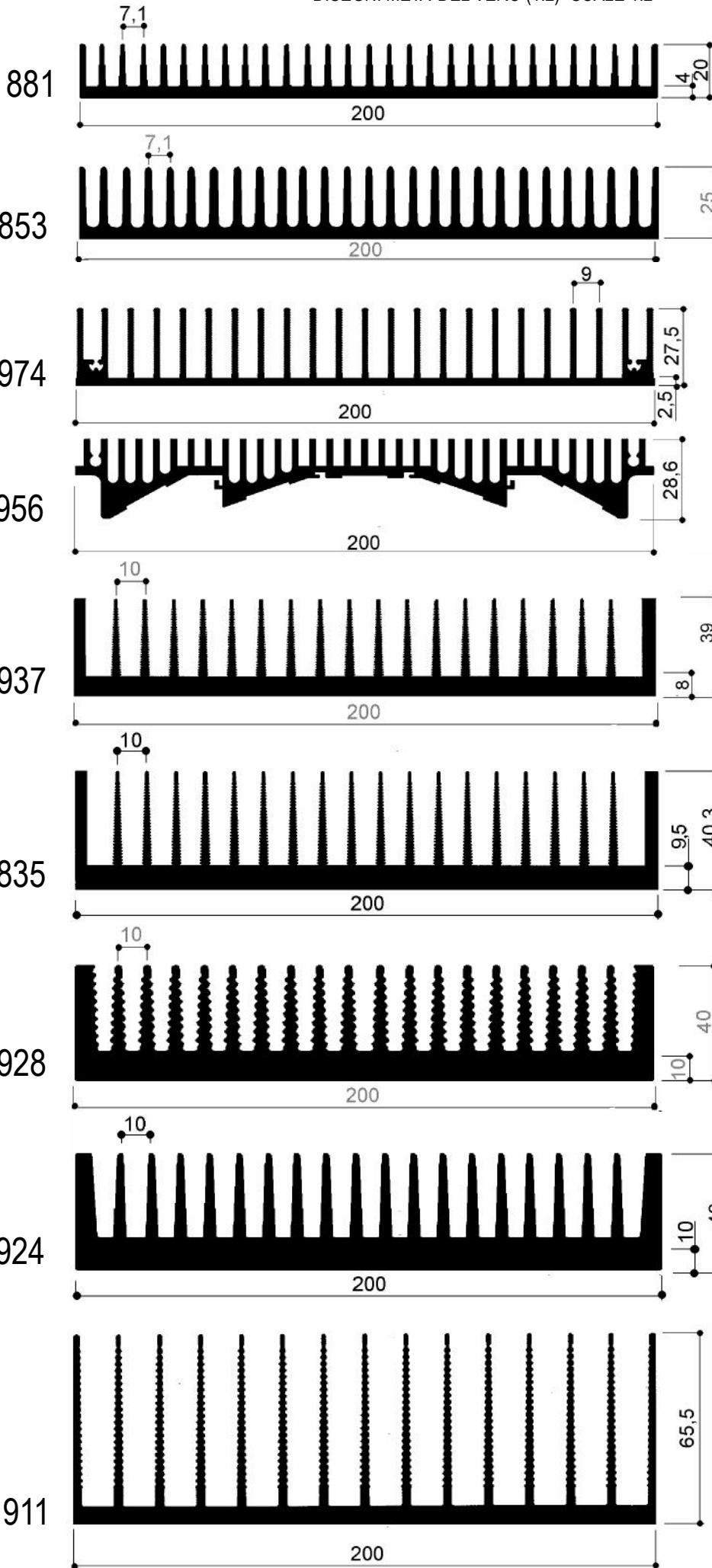

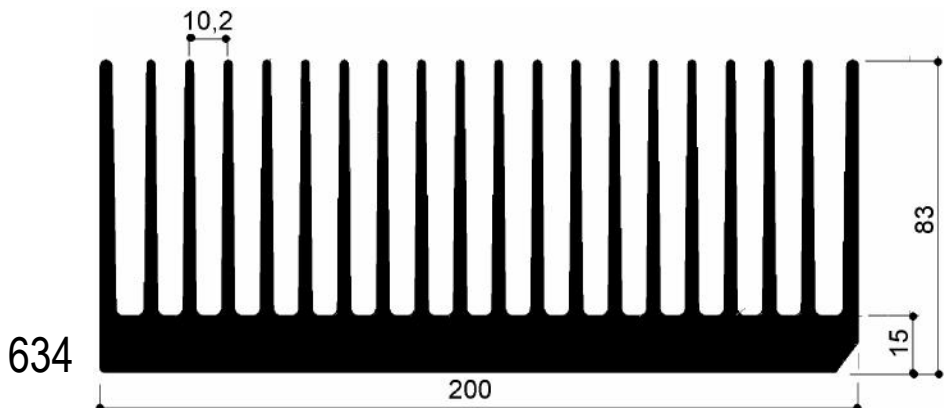
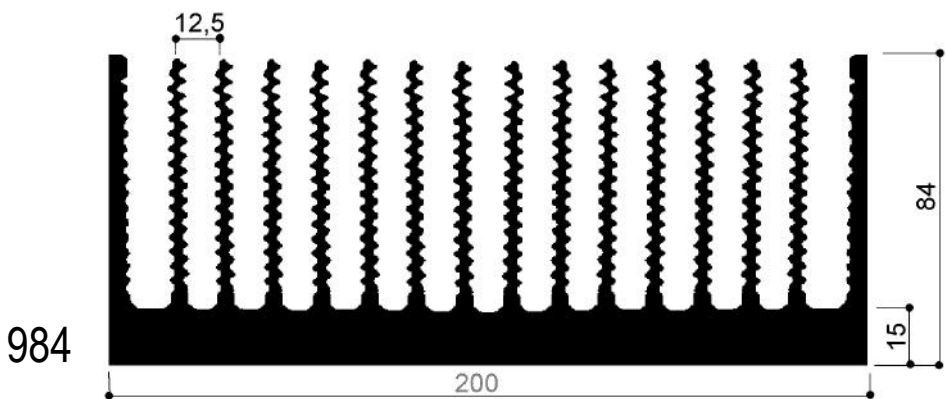
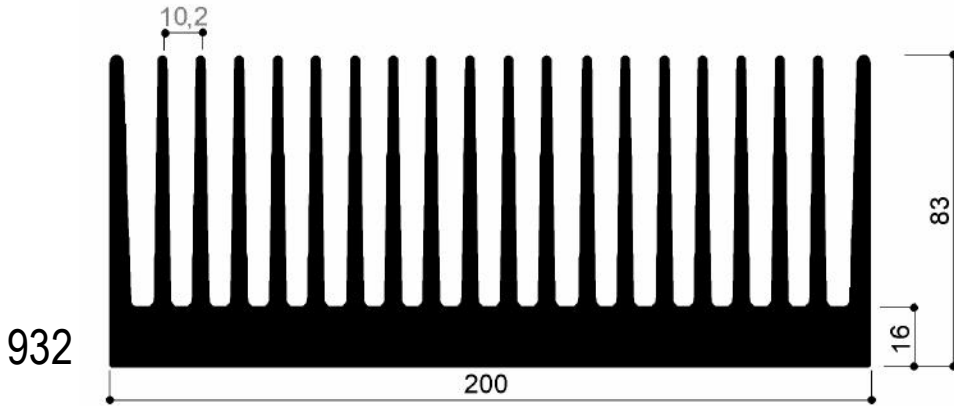
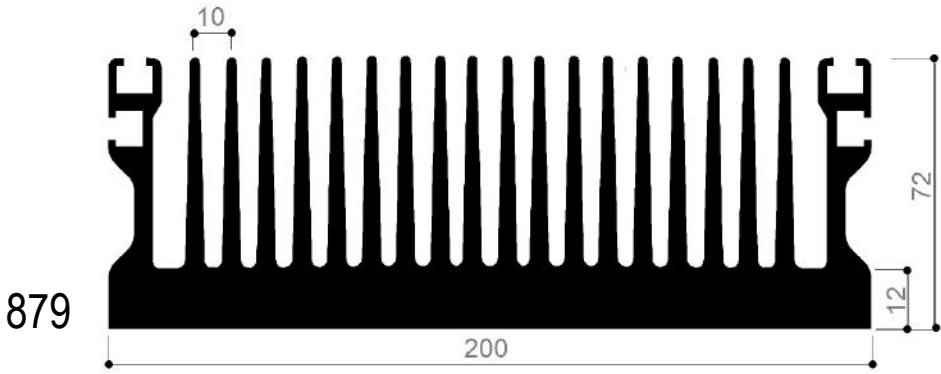
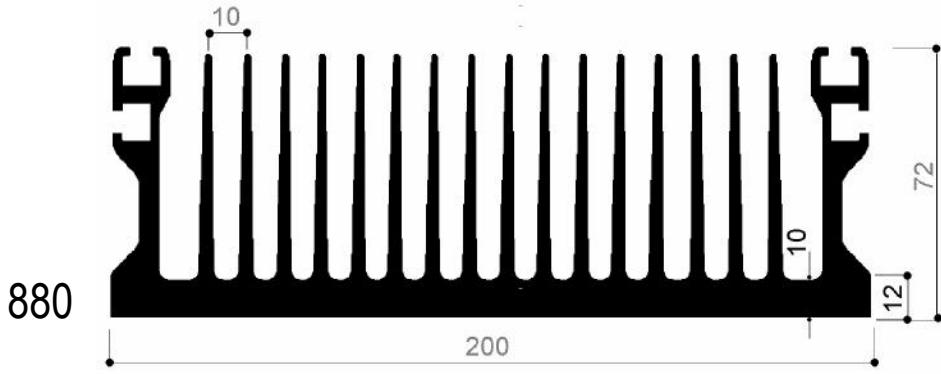

Via Newton, n.12
20016 Pero (Milano - Italy)
Tel.+39 02 3535955 r.a. Fax.+39 02 3539929
E-Mail: info@omar-alluminio.it

Cataloghi Online: www.omar-alluminio.it
www.omar-alluminio.com

PROFILATI ALLUMINIO A DISEGNO / STANDARD / SPECIALI / E PER:
ELETTRONICA / LED / FOTOVOLTAICO / AUTOMAZIONE ROBOTICA / PNEUMATICA / AUTOMOTIVE



DISEGNI META' DEL VERO (1:2)- SCALE 1:2

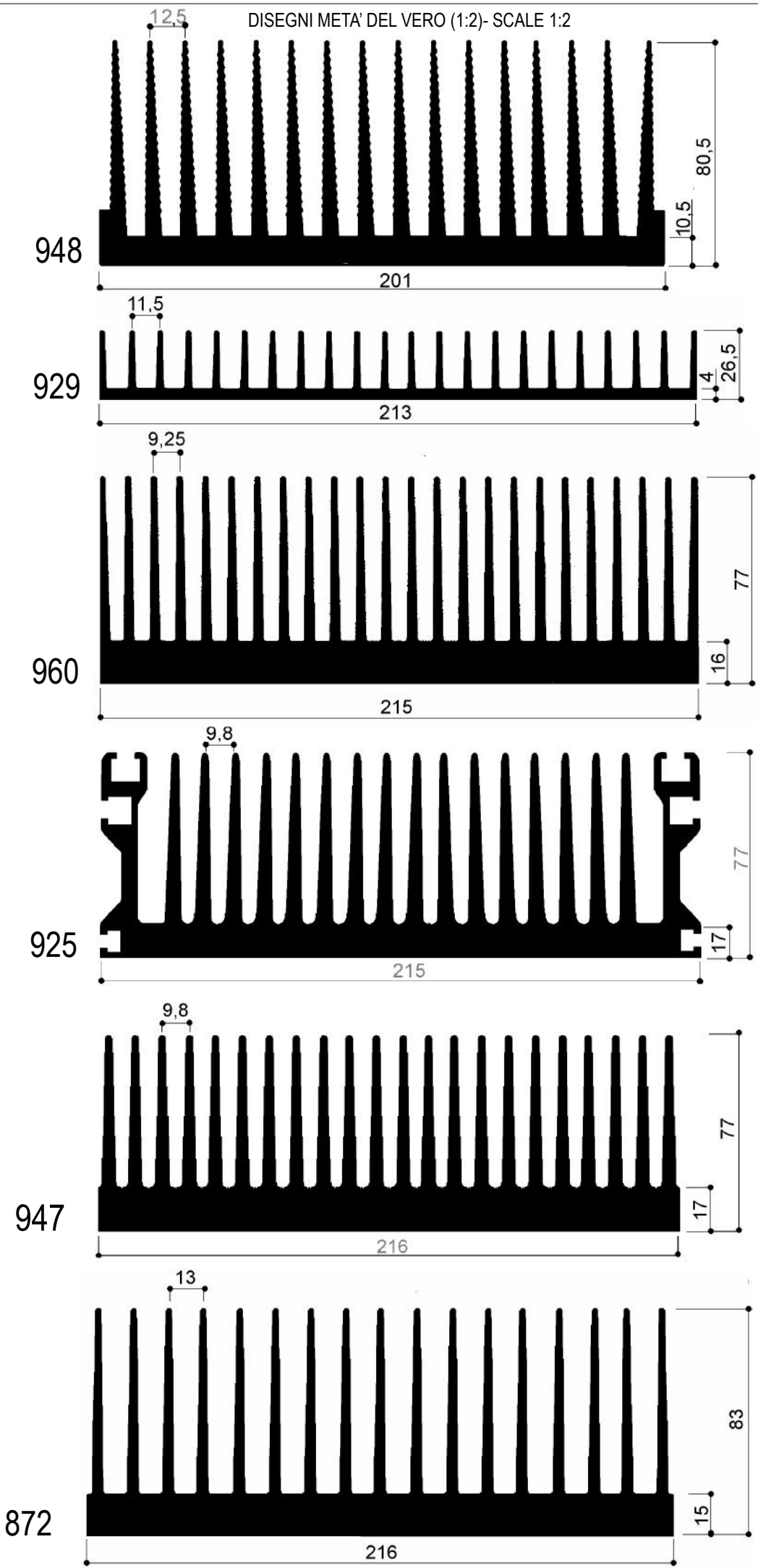

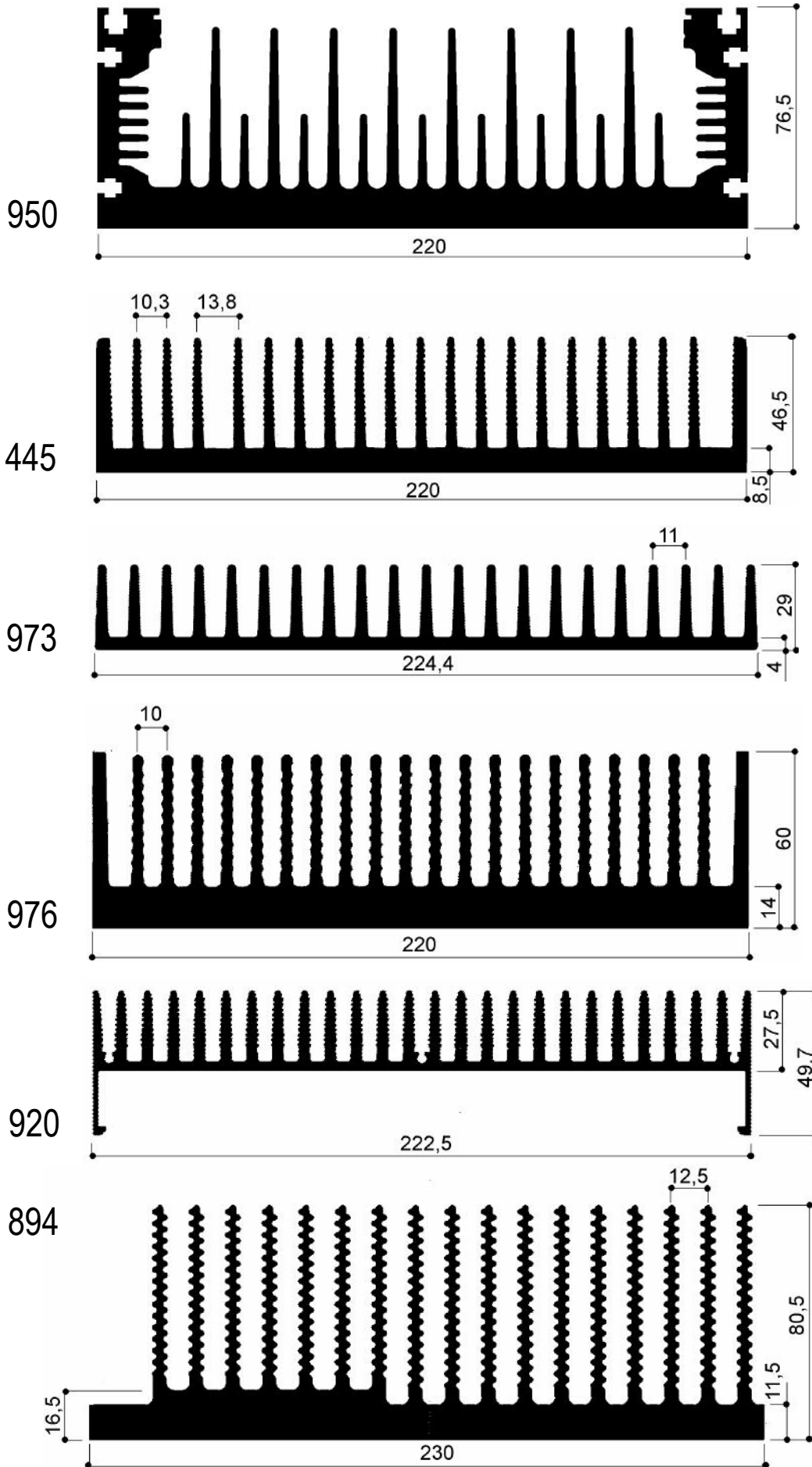

Via Newton, n.12
 20016 Pero (Milano - Italy)
 Tel. +39 02 3535955 r.a. Fax. +39 02 3539929
 E-Mail: info@omar-alluminio.it

Cataloghi Online: www.omar-alluminio.it
www.omar-alluminio.com

PROFILATI ALLUMINIO A DISEGNO / STANDARD / SPECIALI / E PER:
 ELETTRONICA / LED / FOTOVOLTAICO / AUTOMAZIONE ROBOTICA / PNEUMATICA / AUTOMOTIVE



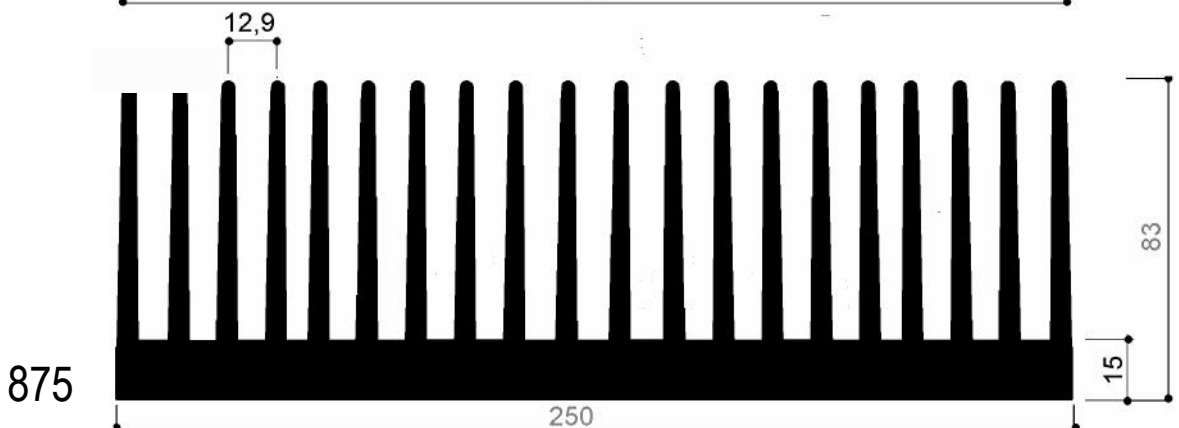
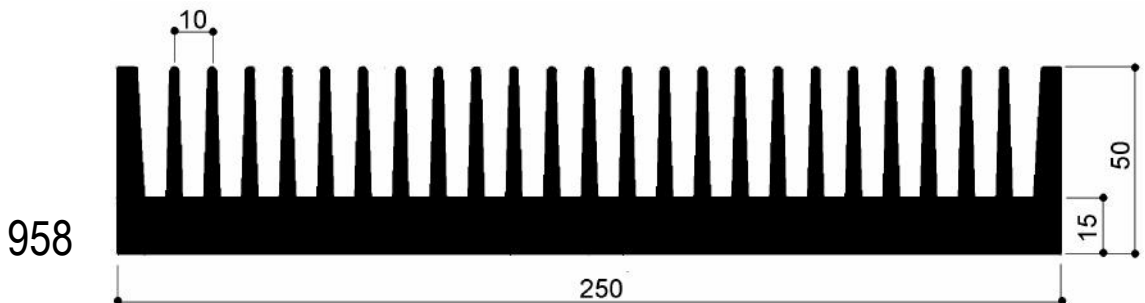
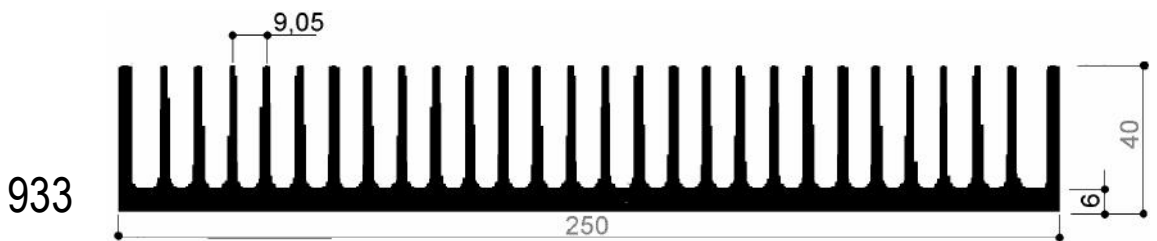
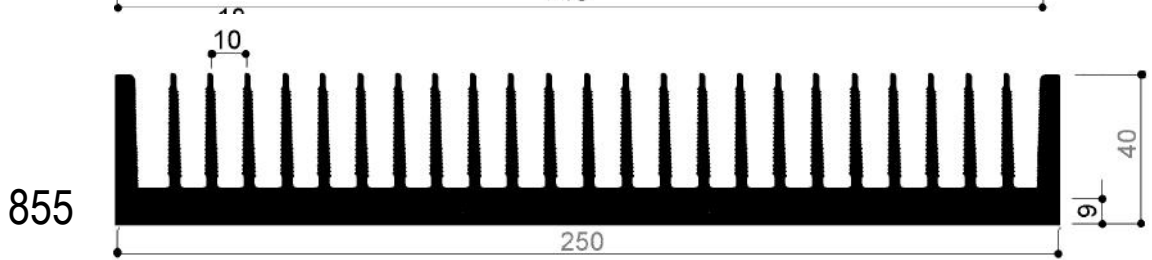
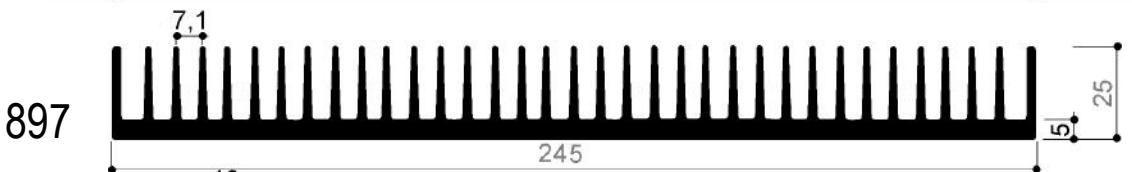
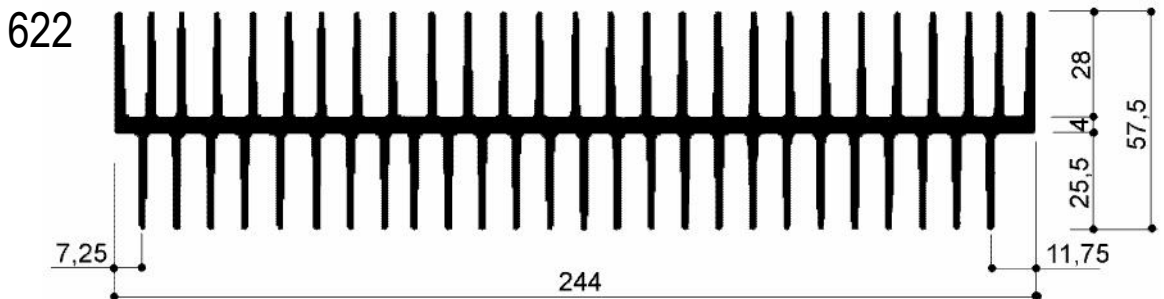
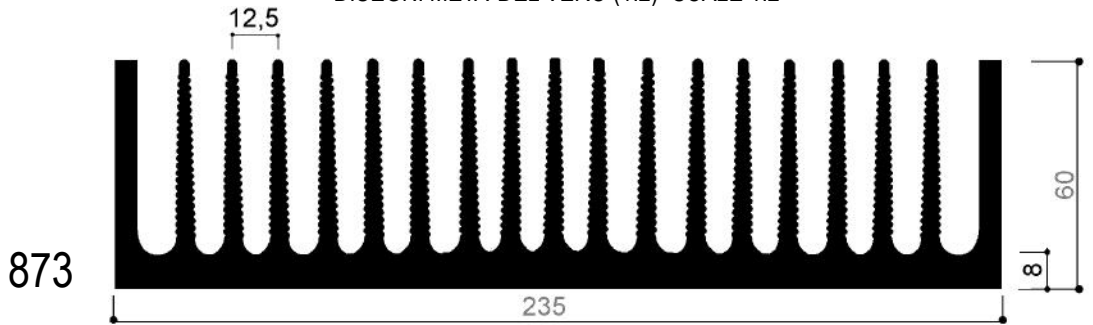

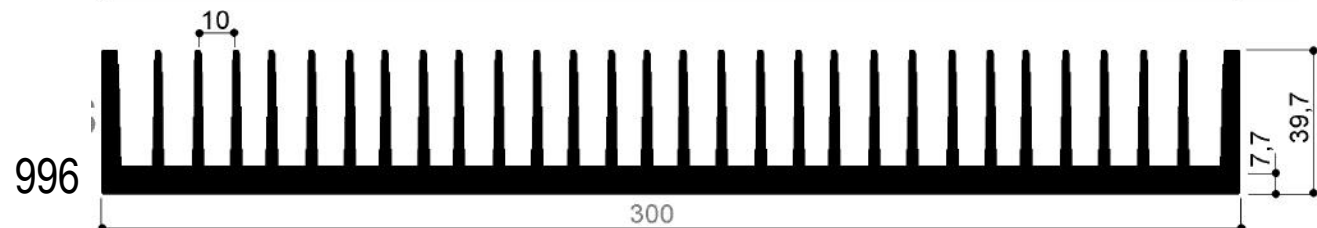
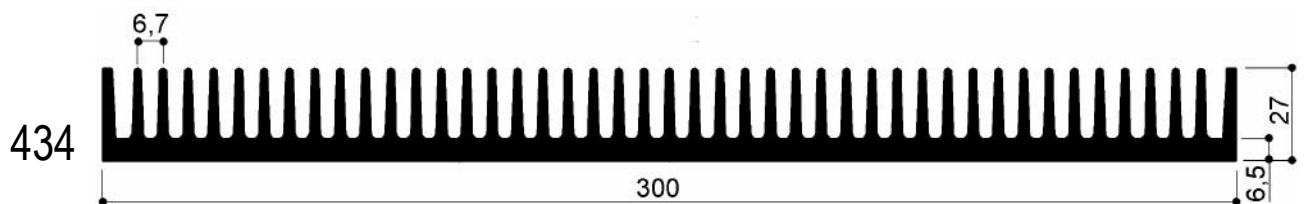
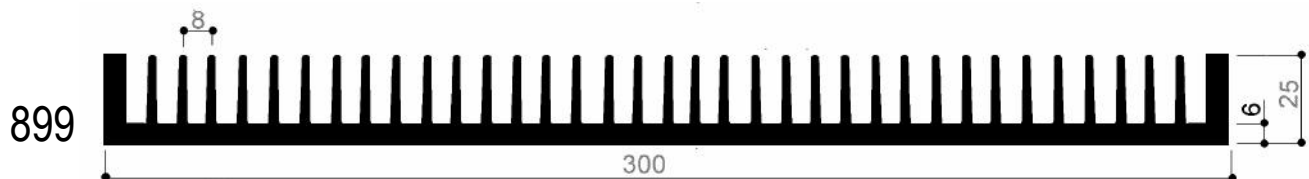
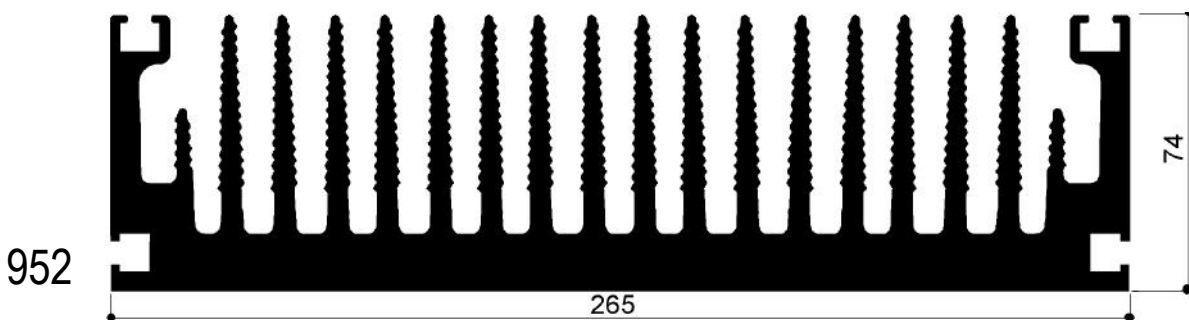
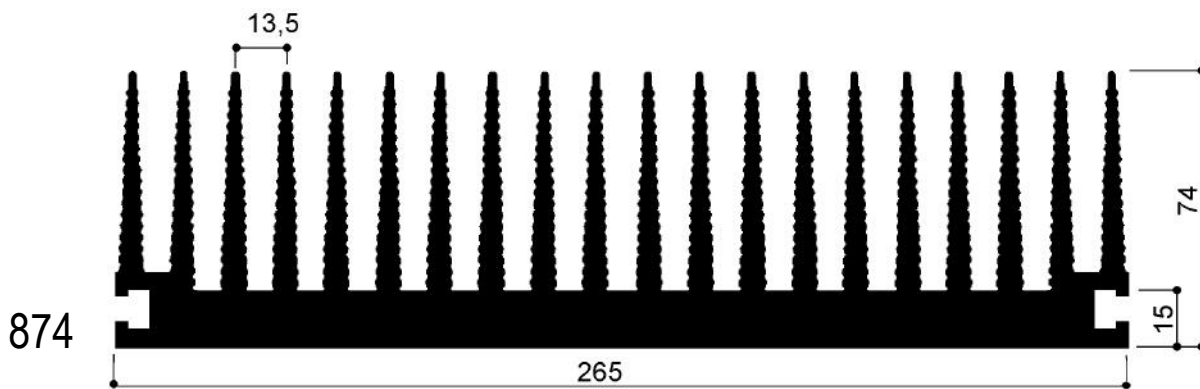
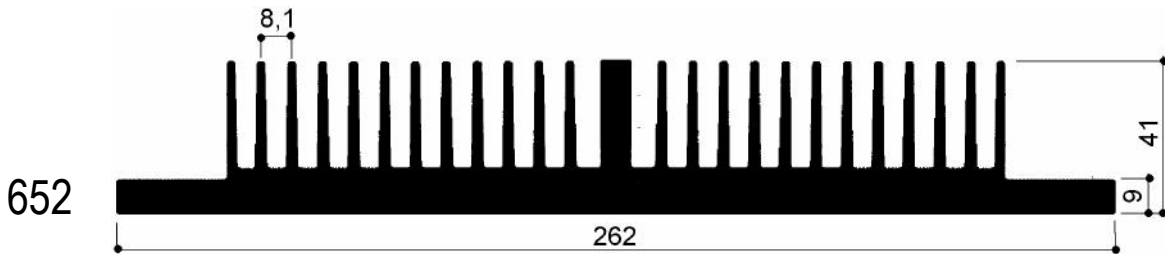
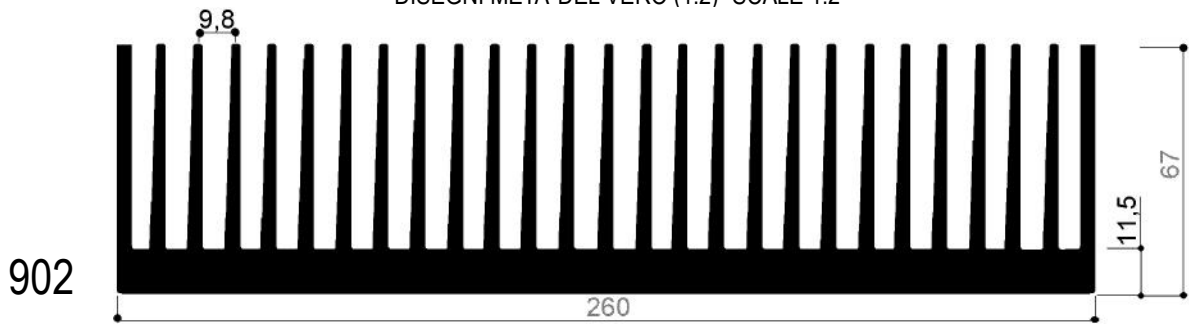

Via Newton, n.12

20016 Pero (Milano - Italy)

Tel. +39 02 3535955 r.a. Fax. +39 02 3539929

E-Mail: info@omar-alluminio.it

Cataloghi Online: www.omar-alluminio.it

www.omar-alluminio.com

PROFILATI ALLUMINIO A DISEGNO / STANDARD / SPECIALI / E PER:

ELETTRONICA / LED / FOTOVOLTAICO / AUTOMAZIONE ROBOTICA / PNEUMATICA / AUTOMOTIVE



Via Newton, n.12
 20016 Pero (Milano - Italy)
 Tel. +39 02 3535955 r.a. Fax. +39 02 3539929
 E.Mail: info@omar-alluminio.it

Cataloghi Online: www.omar-alluminio.it
www.omar-alluminio.com

PROFILATI ALLUMINIO A DISEGNO / STANDARD / SPECIALI / E PER:
 ELETTRONICA / LED / FOTOVOLTAICO / AUTOMAZIONE ROBOTICA / PNEUMATICA / AUTOMOTIVE

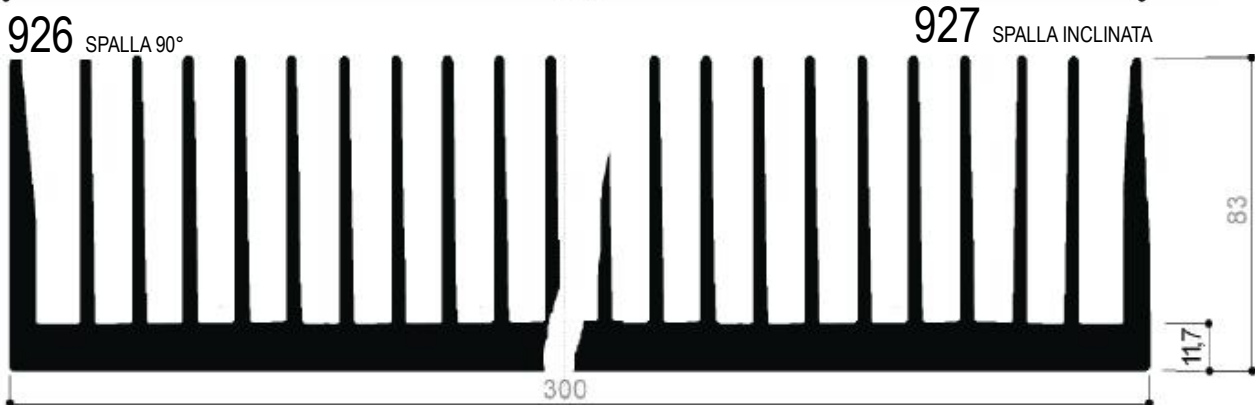
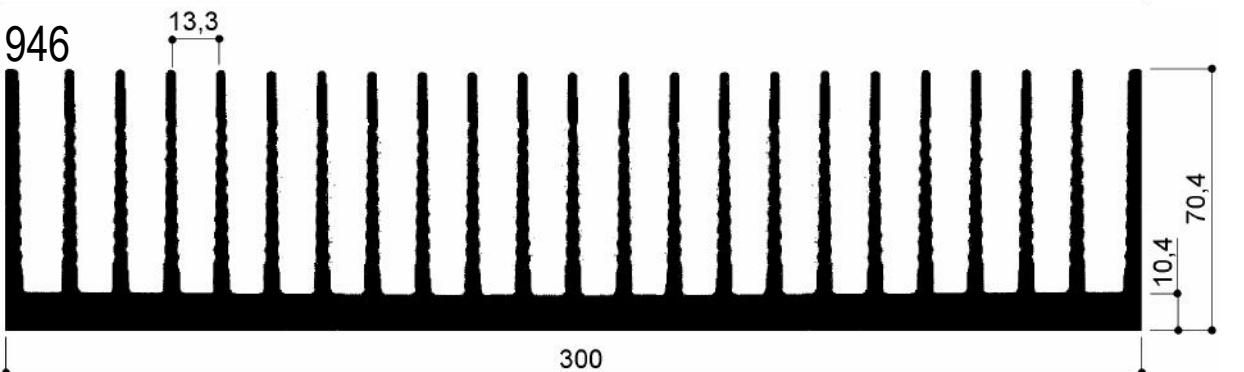
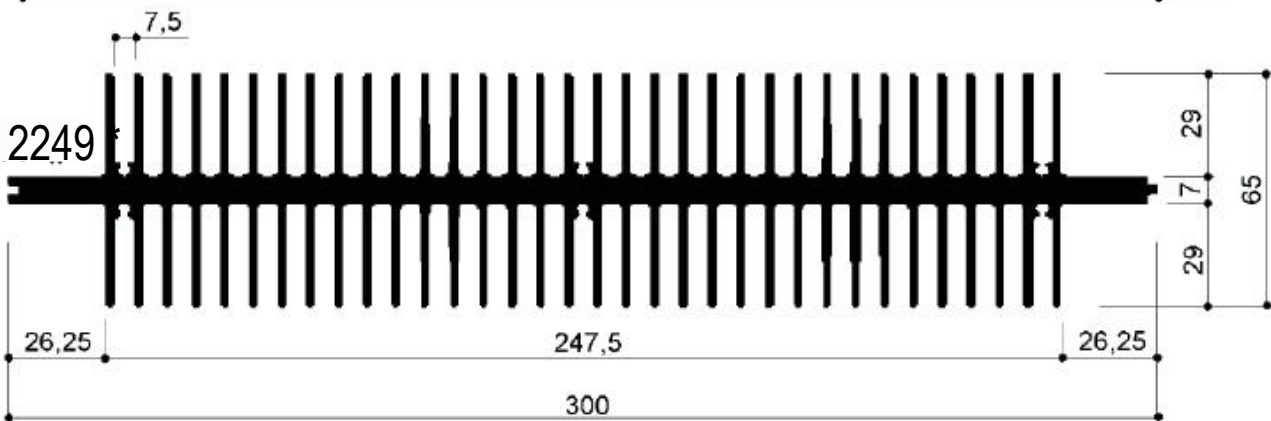
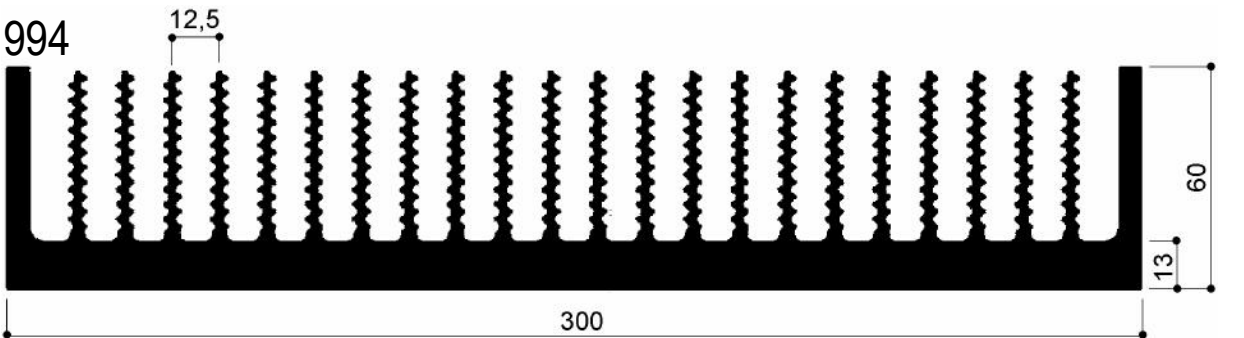
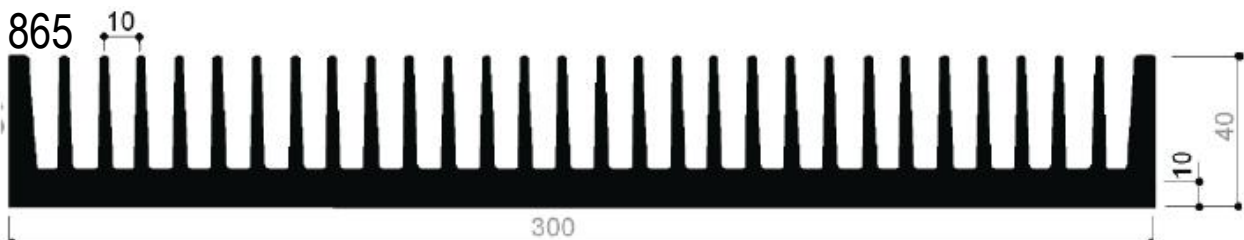
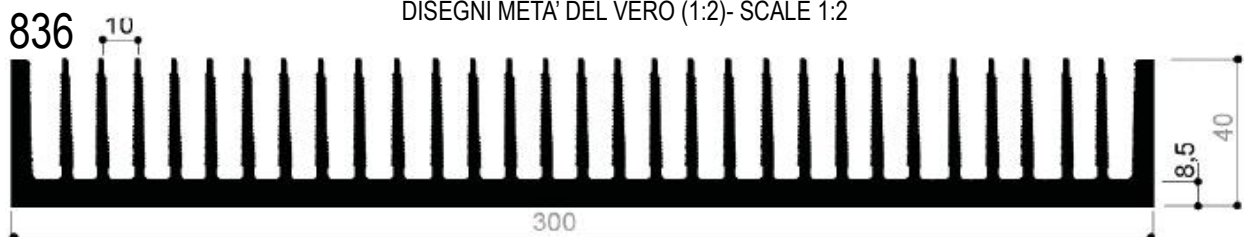

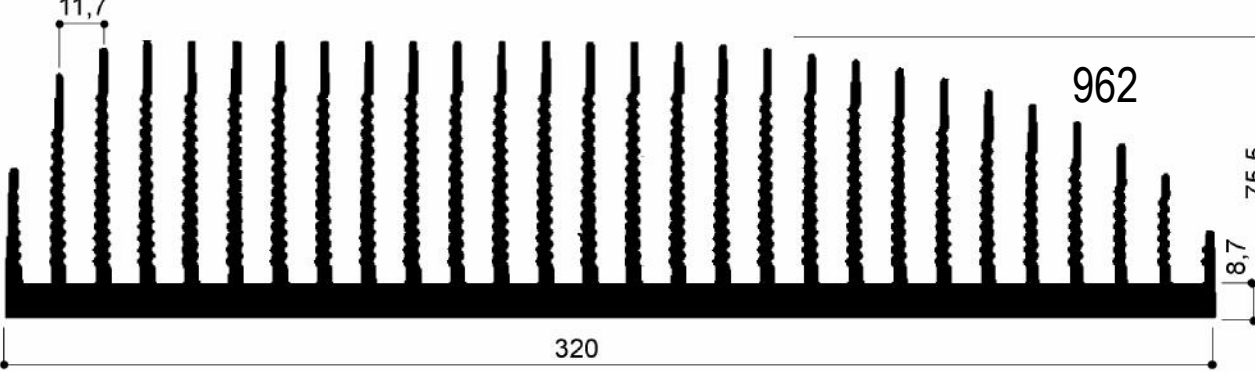
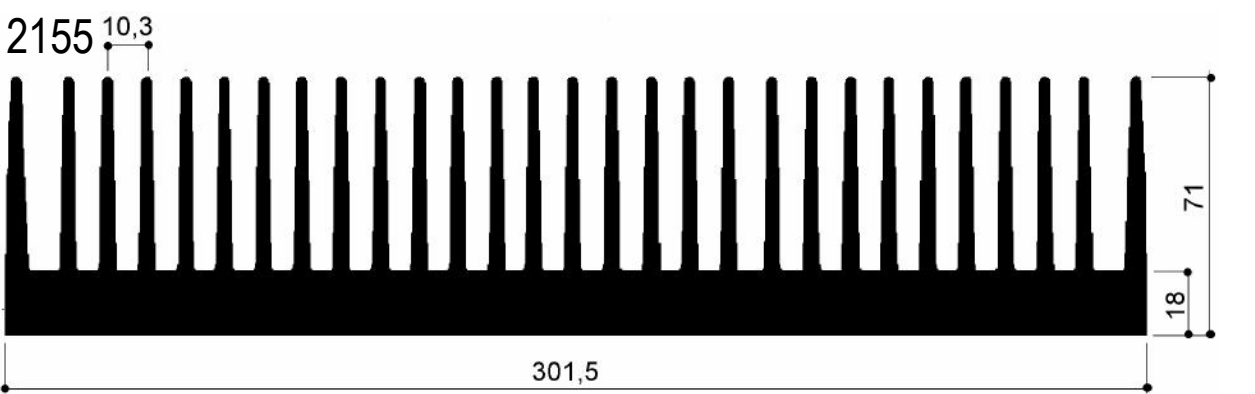
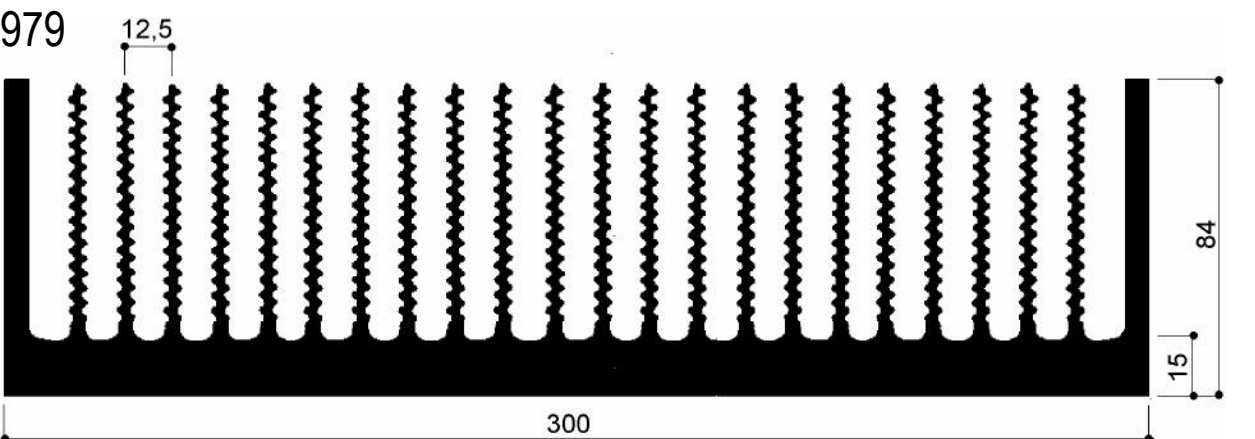
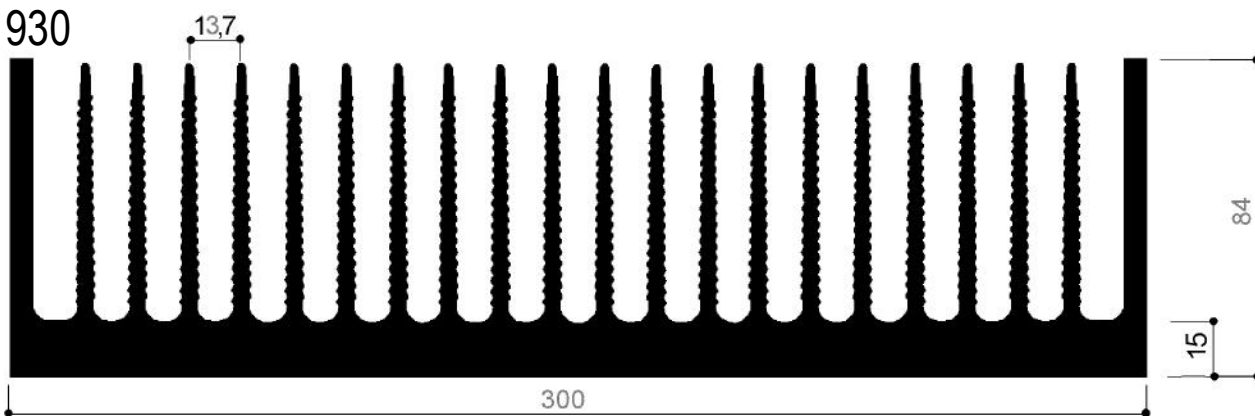
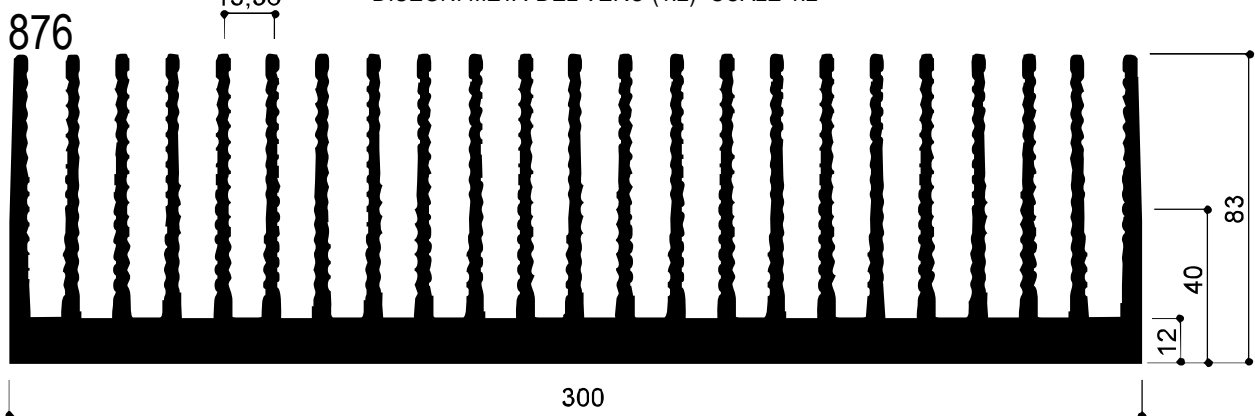

AGGIORNAMENTO CONTINUO - ED. DEL 03-2023 - RIPRODUZIONE VIETATA-

Via Newton, n.12
 20016 Pero (Milano - Italy)
 Tel. +39 02 3535955 r.a. Fax. +39 02 3539929
 E-Mail: info@omar-alluminio.it

Cataloghi Online: www.omar-alluminio.it
www.omar-alluminio.com
 PROFILATI ALLUMINIO A DISEGNO / STANDARD / SPECIALI / E PER:
 ELETTRONICA / LED / FOTOVOLTAICO / AUTOMAZIONE ROBOTICA / PNEUMATICA / AUTOMOTIVE



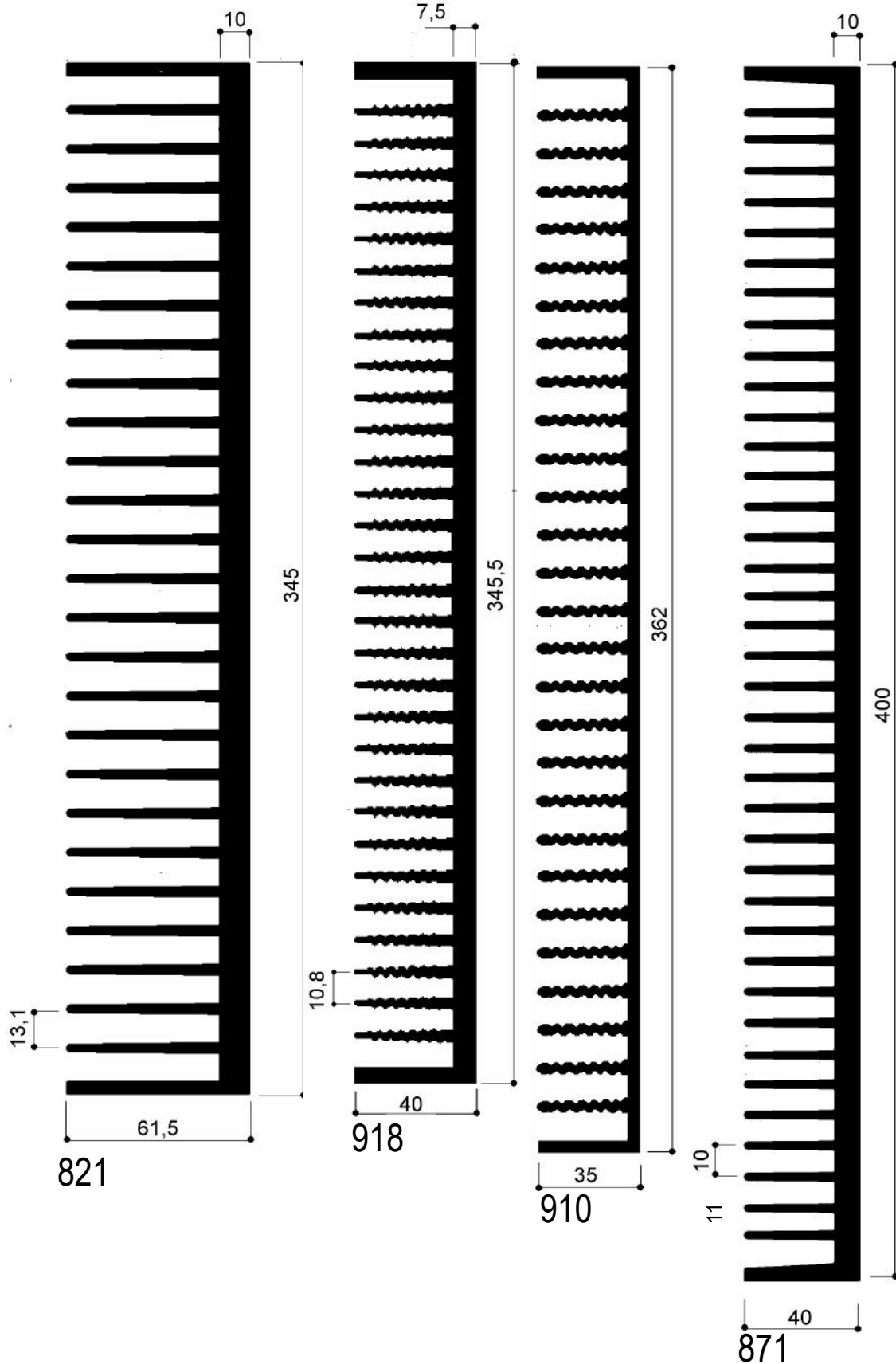

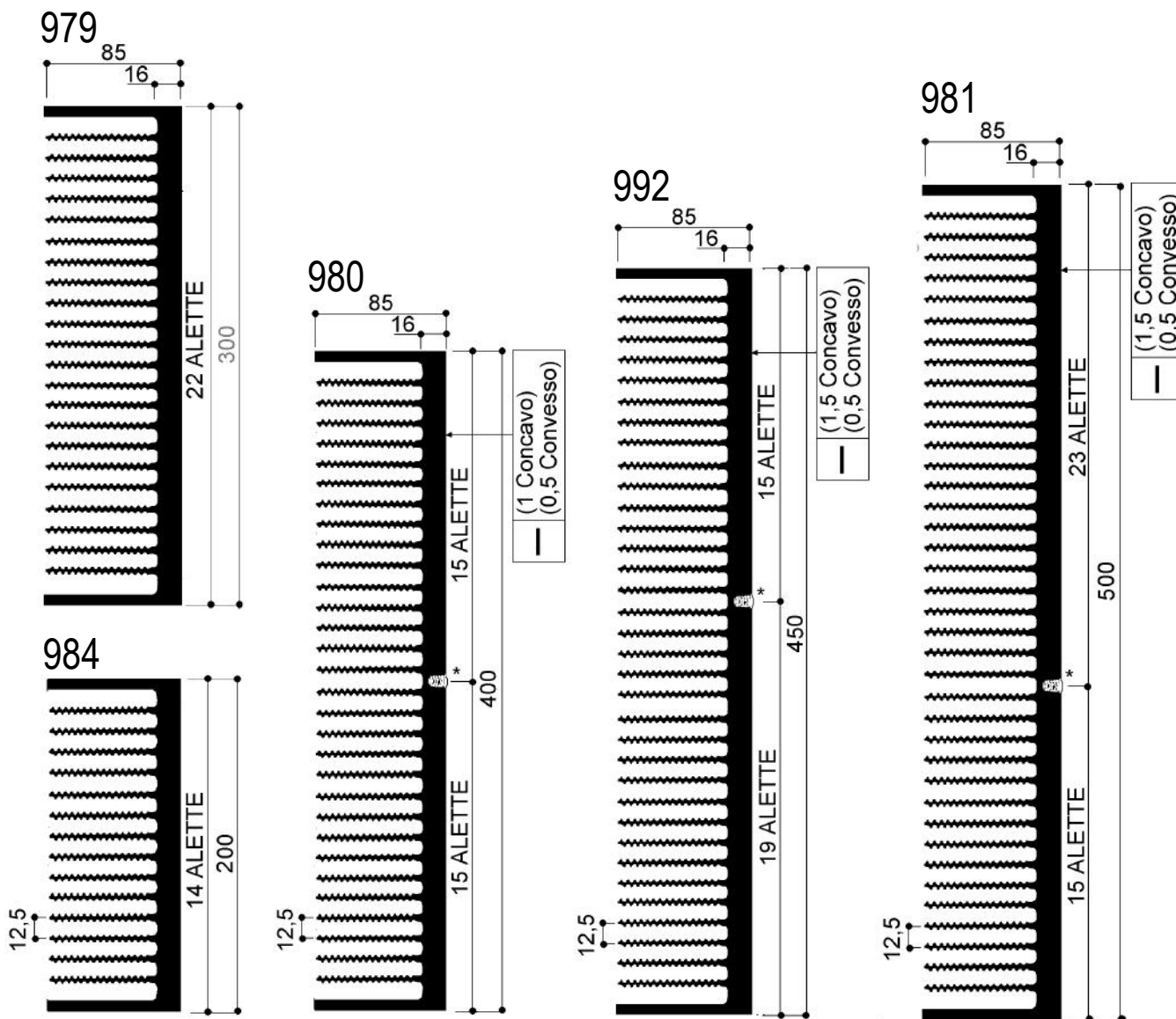

SALDATURA IN ACCORDO ALLA NORMA EN288-4:1992 / A1:1997

WELDING PROCESS ACCORDING TO EN288-4:1992 / A1:1997

*CORDONE DI SALDATURA - WELDING WIRE

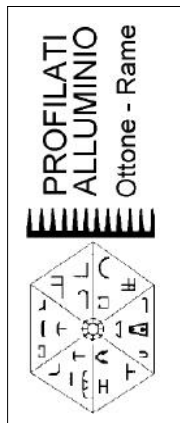

OLTRE AI PROFILI RIPORTATI A CATALOGO PRONTI A MAGAZZINO SIAMO IN GRADO DI FORNIRE DISSIPATORI IN BARRE CON SAGOME 'CUSTOM' ANCHE PER MODESTI QUANTITATIVI.

TUTTI I PROFILI SONO FORNIBILI NEI SEGUENTI FORMATI:

- BARRE DA 3 / 4 METRI
- TAGLIATI A MISURA (GREZZI/OSSIDATI)
- COMPLETAMENTE LAVORATO SECONDO VS. DISEGNO

Cataloghi Online: www.omar-alluminio.it

www.omar-alluminio.com

PROFILATI ALLUMINIO A DISEGNO / STANDARD / SPECIALI / E PER:

ELETTRONICA / LED / FOTOVOLTAICO / AUTOMAZIONE ROBOTICA / PNEUMATICA / AUTOMOTIVE

Via Newton, n.12

20016 Pero (Milano - Italy)

Tel. +39 02 3535955 r.a. Fax. +39 02 3539929

E-Mail: info@omar-alluminio.it



SCALA 1:4 - SCALE 1:4

FOTO DI ESEMPIO:
 DISSIPATORI TONDI RICAVATI
 DA BARRA MEDIANTE
 FRESATURA

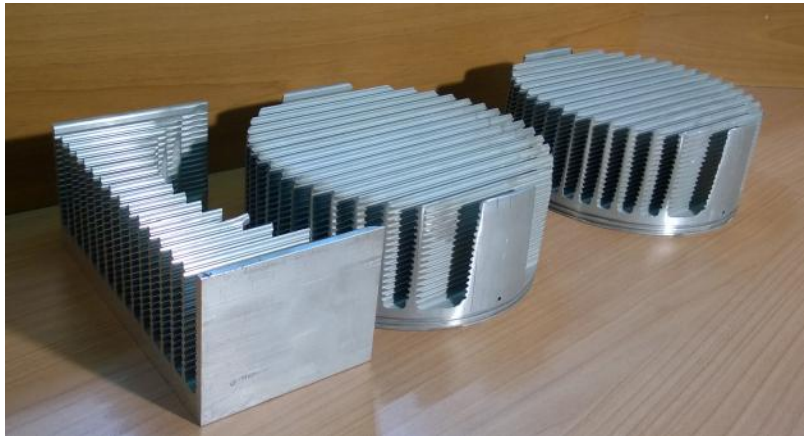

SALDATURA IN ACCORDO ALLA NORMA EN288-4:1992 / A1:1997
 WELDING PROCESS ACCORDING TO EN288-4:1992 / A1:1997
 *CORDONE DI SALDATURA - WELDING WIRE

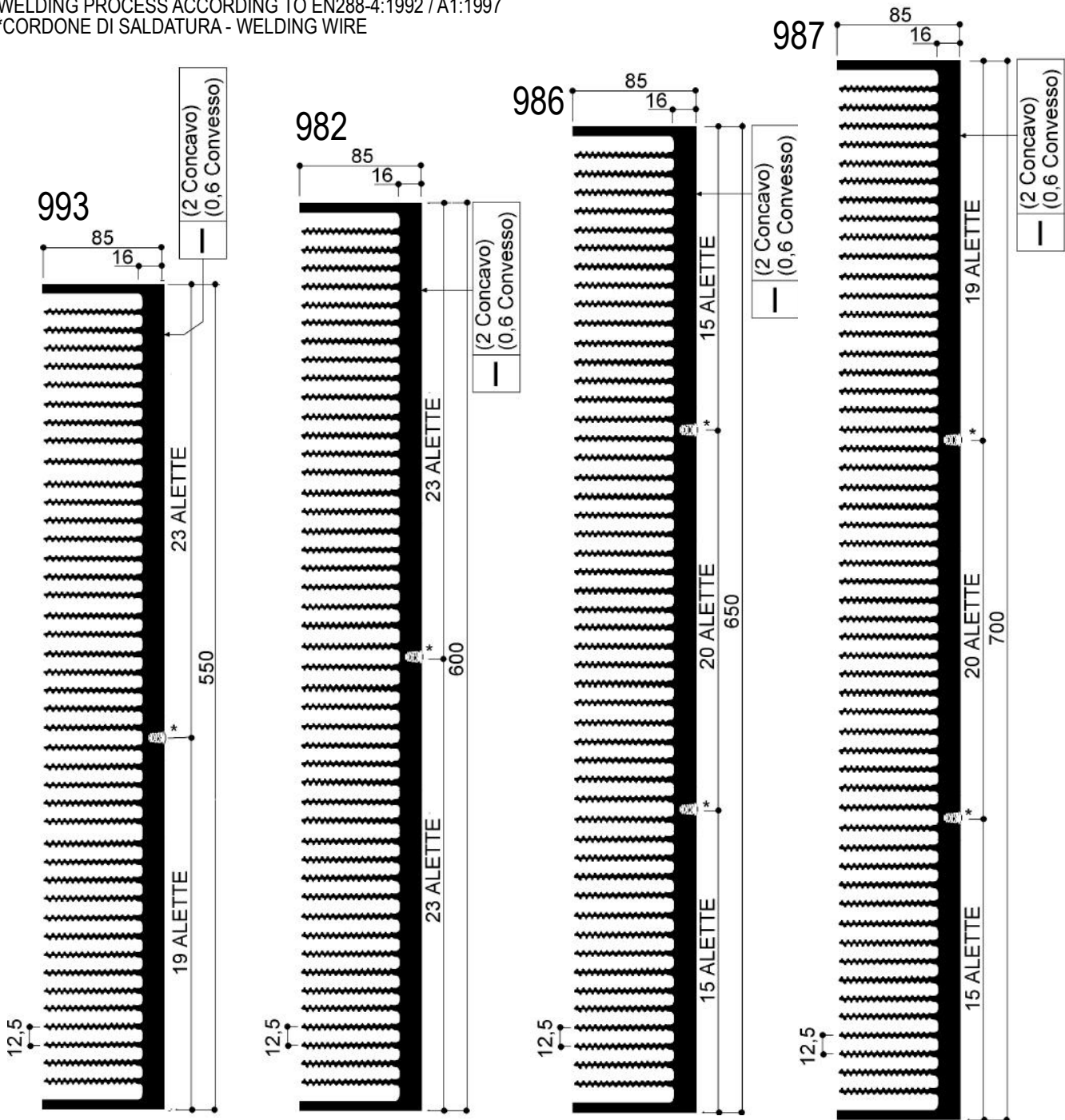

SALDATURA SECONDO NORME EN288-4:1992 / A1:1997
 WELDING PROCESS ACCORDING TO EN288-4:1992 / A1:1997

*CORDONE DI SALDATURA - WELDING WIRE

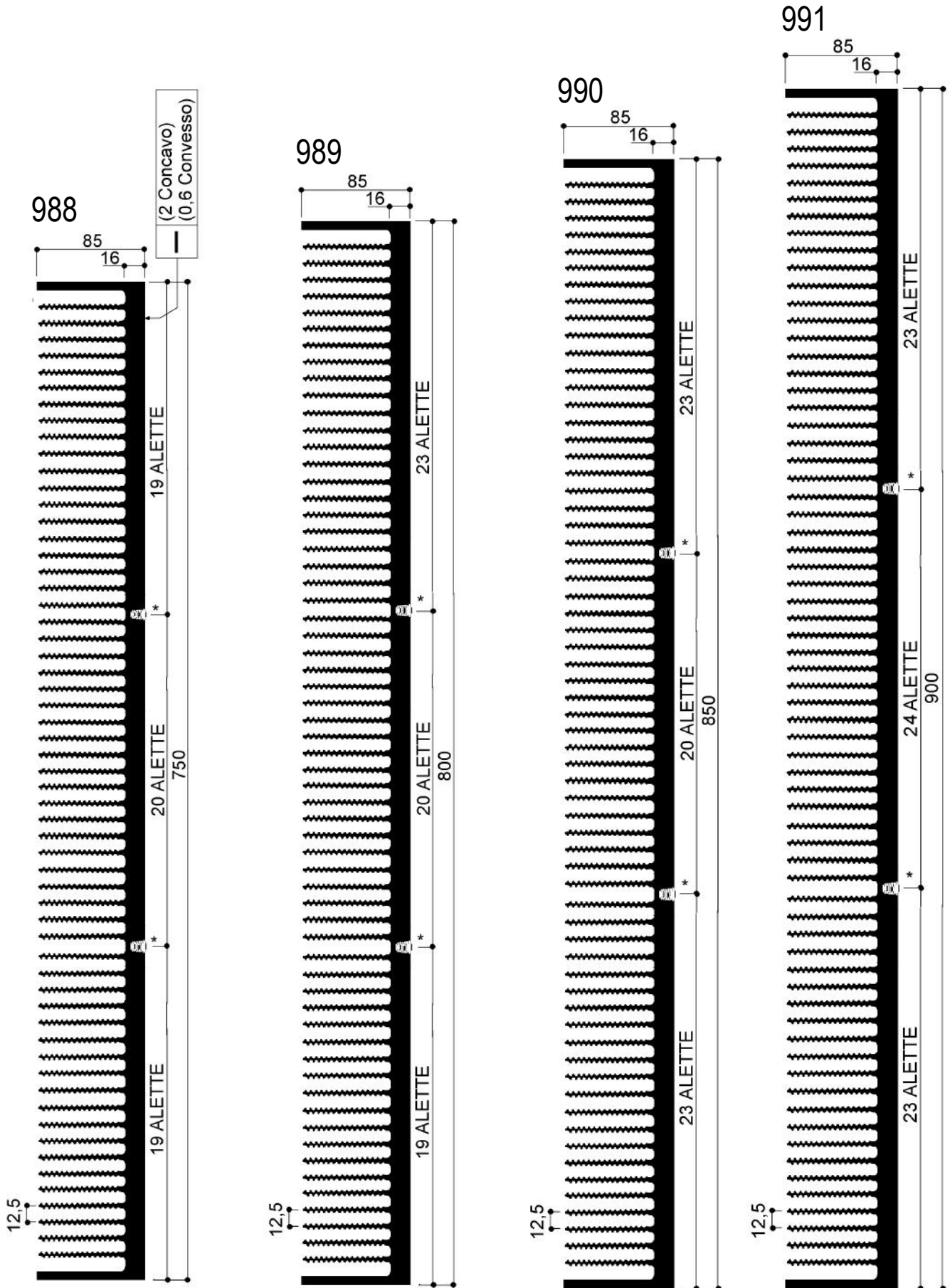

Cataloghi Online: www.omar-alluminio.it
www.omar-alluminio.com

PROFILATI ALLUMINIO A DISEGNO / STANDARD / SPECIALI / E PER:
 ELETTRONICA / LED / FOTOVOLTAICO / AUTOMAZIONE ROBOTICA / PNEUMATICA / AUTOMOTIVE



Via Newton, n.12
 20016 Pero (Milano - Italy)
 Tel. +39 02 3535955 r.a. Fax. +39 02 3539929
 E-Mail: info@omar-alluminio.it

DISSIPATORI AD ALTO RENDIMENTO

DISEGNI META' DEL VERO (1:2)- SCALE 1:2

Via Newton, n.12
20016 Pero (Milano - Italy)
Tel. +39 02 3535955 r.a. Fax. +39 02 3539929
E. Mail: info@omar-alluminio.it

Cataloghi Online: www.omar-alluminio.it
www.omar-alluminio.com

PROFILATI ALLUMINIO A DISEGNO / STANDARD / SPECIALI / E PER:
ELETTRONICA / LED / FOTOVOLTAICO / AUTOMAZIONE ROBOTICA / PNEUMATICA / AUTOMOTIVE

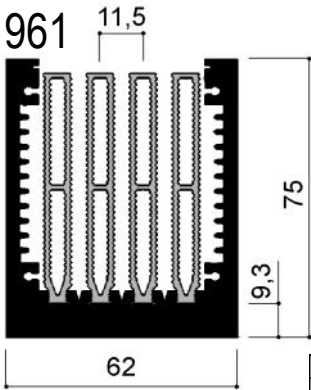

Resistenza termica (KW) in ventilazione forzata

Lg. (mm)	100	200	300
R _{th} a 5m/s	0,23	0,18	0,14

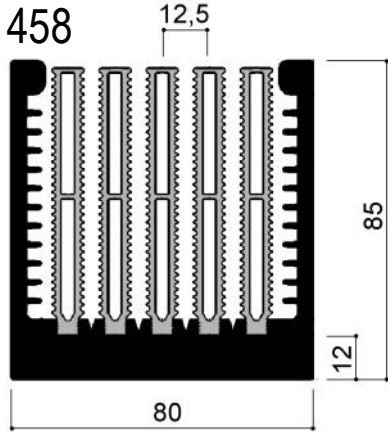
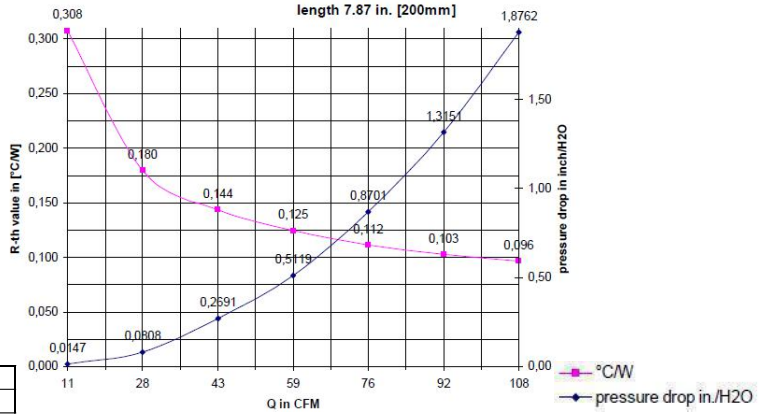

Resistenza termica (KW) in ventilazione forzata

Lg. (mm)	100	200	300
R _{th} a 5m/s	0,165	0,13	0,1

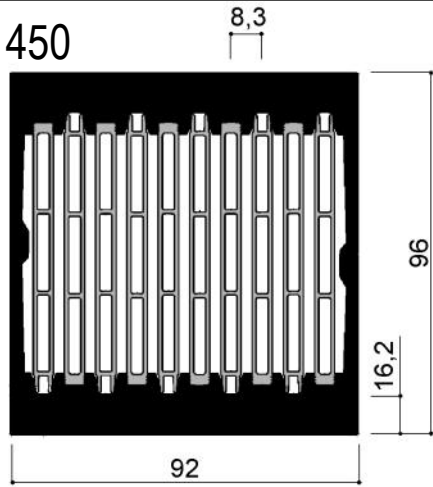
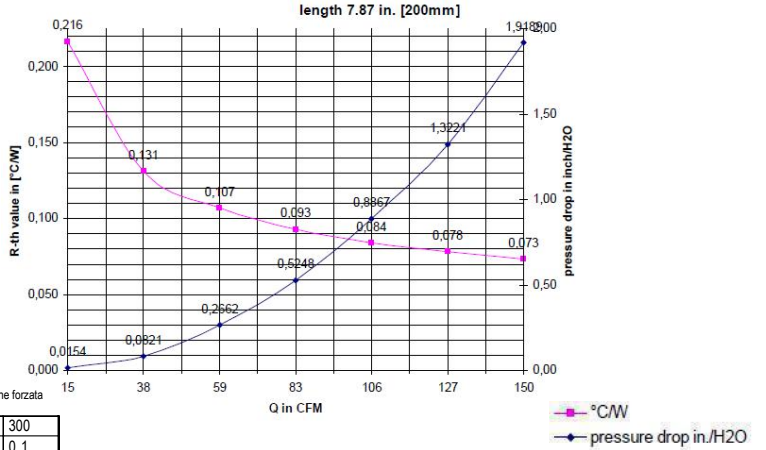

Resistenza termica (KW) in ventilazione forzata

Lg. (mm)	100	200	300
R _{th} a 5m/s	0,13	0,1	0,08

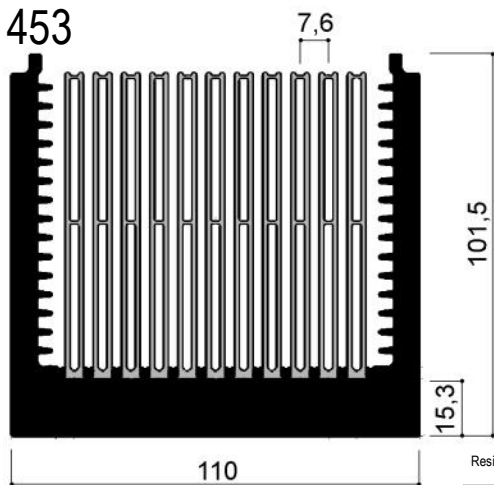
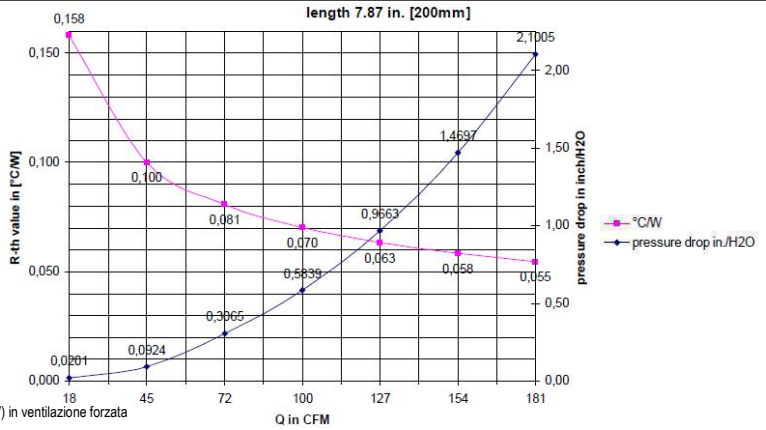

Resistenza termica (KW) in ventilazione forzata

Lg. (mm)	100	200	300
R _{th} a 11m/s	0,0915	0,0579	0,0450

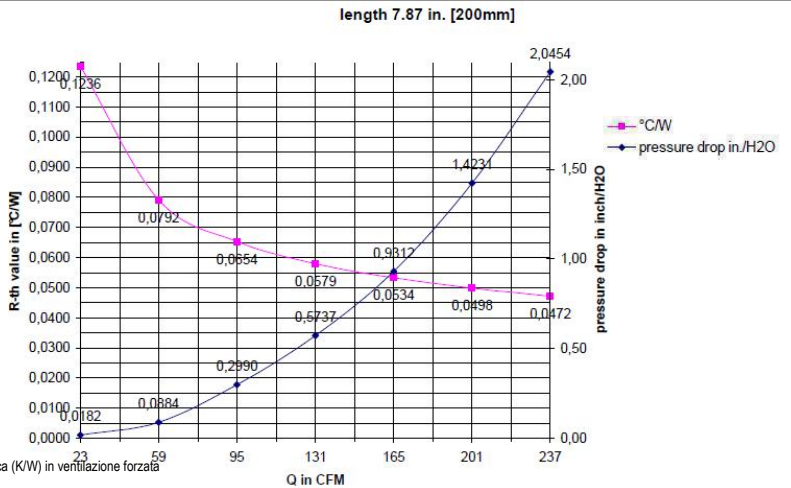

DISSIPATORI AD ALTO RENDIMENTO



DISEGNI META' DEL VERO (1:2)- SCALE 1:2

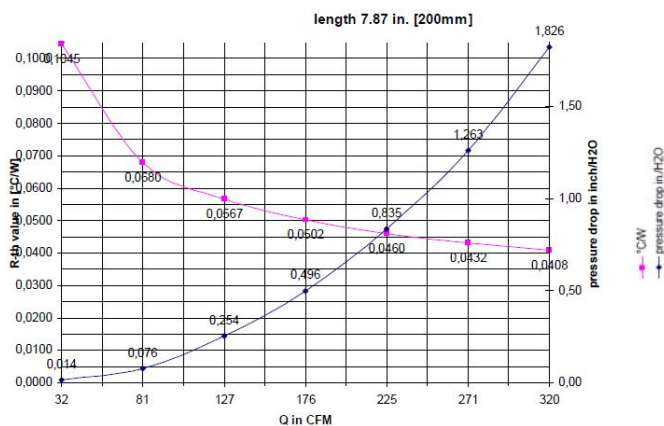
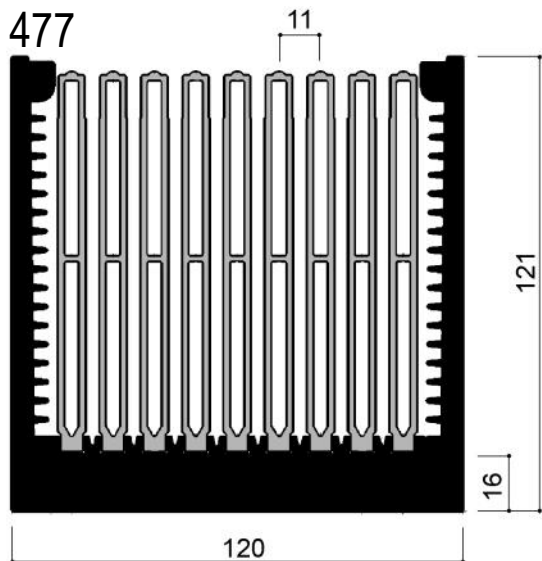

Resistenza termica (KW) in ventilazione forzata

Lg. (mm)	100	200	300
R _n a 5m/s	0,11	0,068	0,052

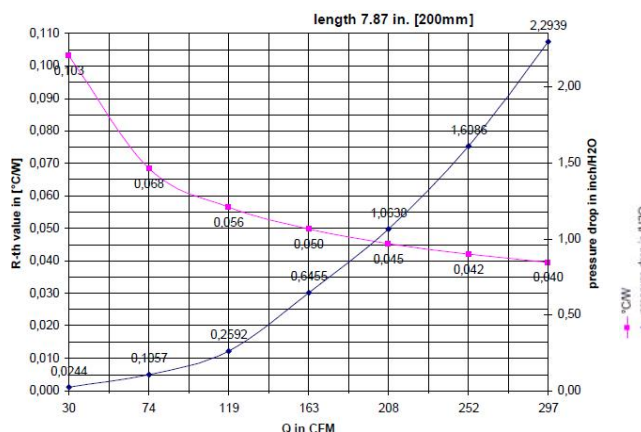
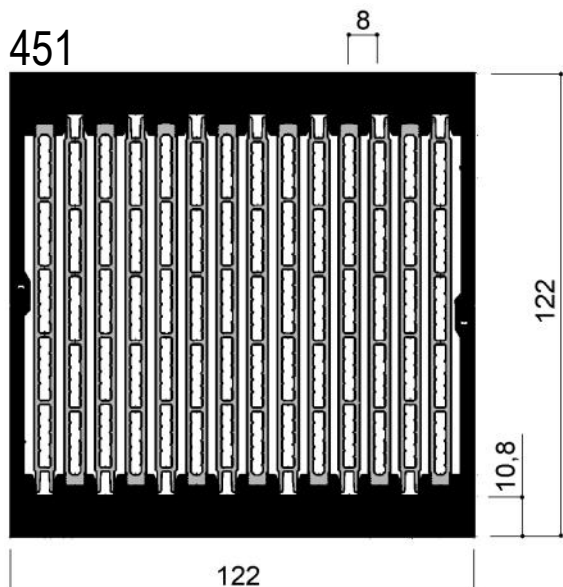

Resistenza termica (KW) in ventilazione forzata

Lg. (mm)	100	200	300
R _n a 5m/s	0,082	0,068	0,052

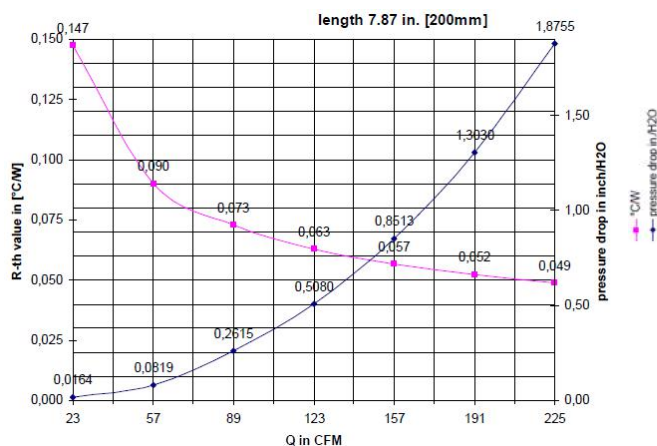
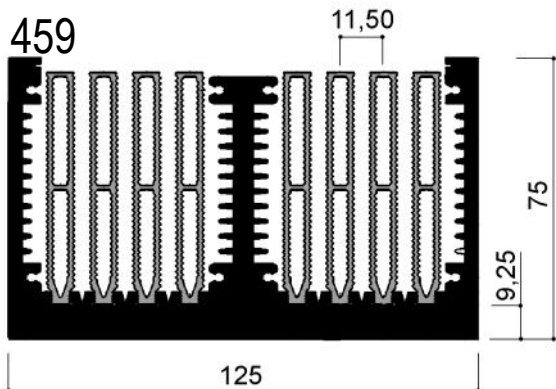

Via Newton, n.12
20016 Pero (Milano - Italy)
Tel.+39 02 3535955 r.a. Fax.+39 02 3539929
E-Mail: info@omar-alluminio.it

Cataloghi Online: www.omar-alluminio.it
www.omar-alluminio.com
PROFILATI ALLUMINIO A DISEGNO / STANDARD / SPECIALI / E PER:
ELETTRONICA / LED / FOTOVOLTAICO / AUTOMAZIONE ROBOTICA / PNEUMATICA / AUTOMOTIVE



DISSIPATORI AD ALTO RENDIMENTO

DISEGNI META' DEL VERO (1:2)- SCALE 1:2

Via Newton, n.12
20016 Pero (Milano - Italy)
Tel. +39 02 3535955 r.a. Fax. +39 02 3539929
E.Mail: info@omar-alluminio.it

Cataloghi Online: www.omar-alluminio.it
www.omar-alluminio.com

PROFILATI ALLUMINIO A DISEGNO / STANDARD / SPECIALI / E PER:
ELETTRONICA / LED / FOTOVOLTAICO / AUTOMAZIONE ROBOTICA / PNEUMATICA / AUTOMOTIVE

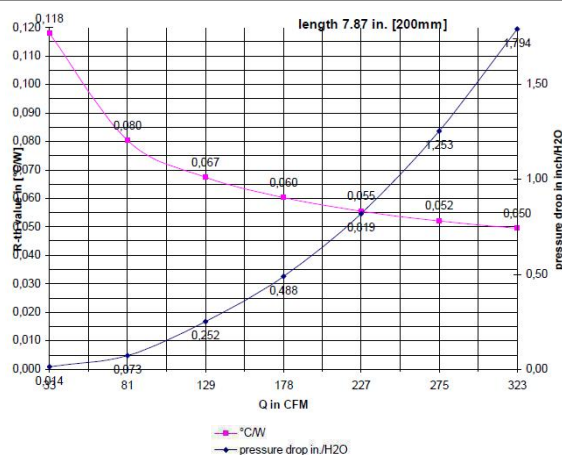
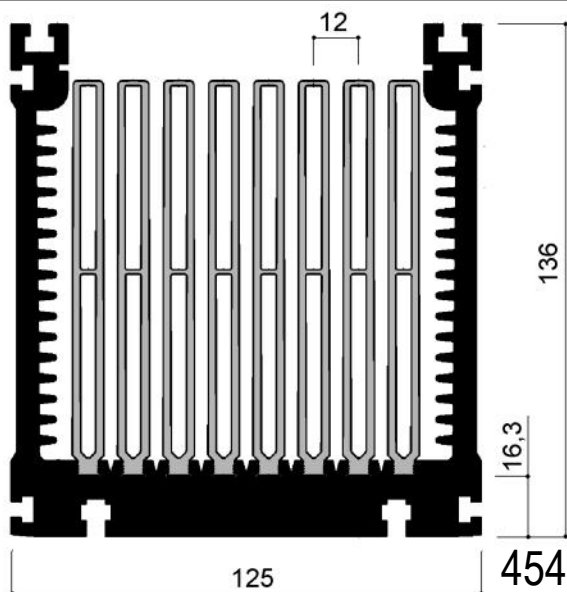

Resistenza termica (K/W) in ventilazione forzata

Lg. (mm)	100	200	300
R _{th} a 5m/s	0,13	0,08	0,06

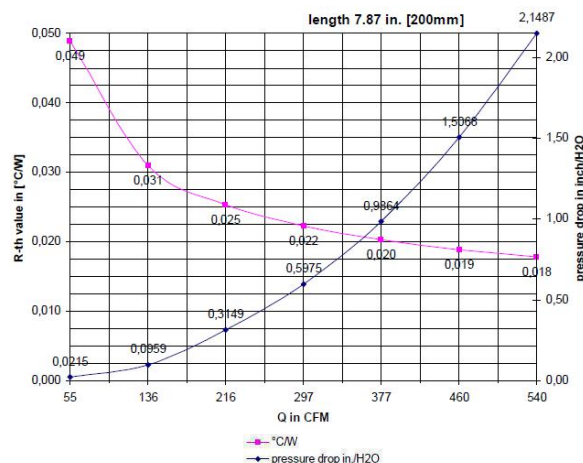
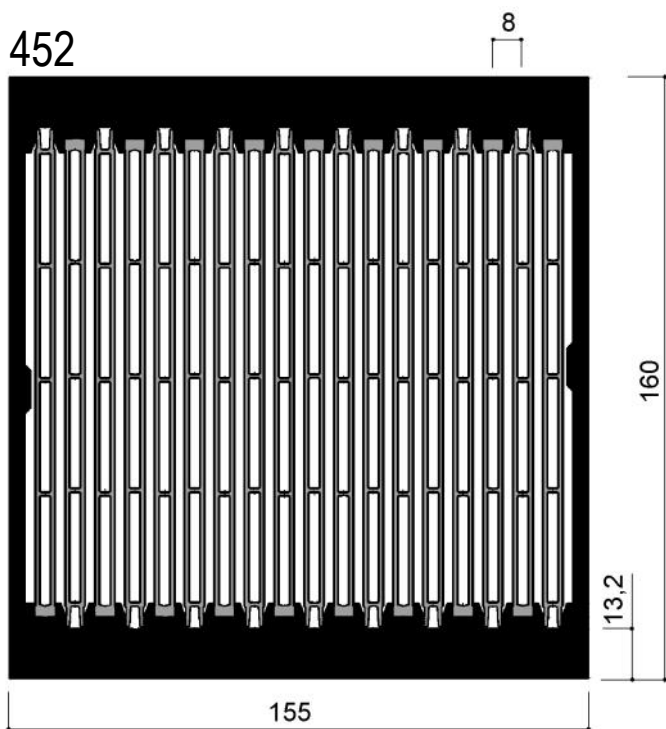

Resistenza termica (K/W) in ventilazione forzata

Lg. (mm)	100	200	300
R _{th} a 5m/s	0,046	0,031	0,025

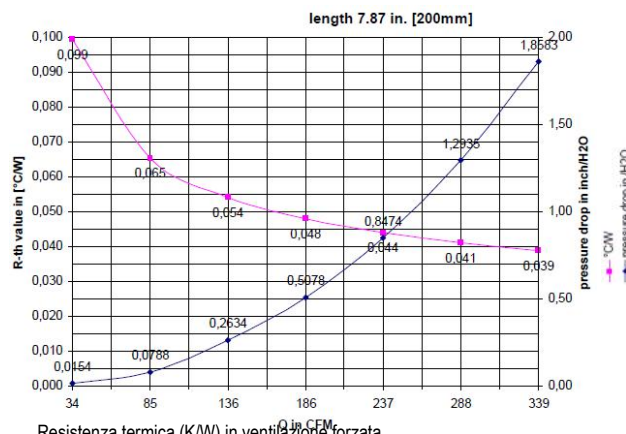
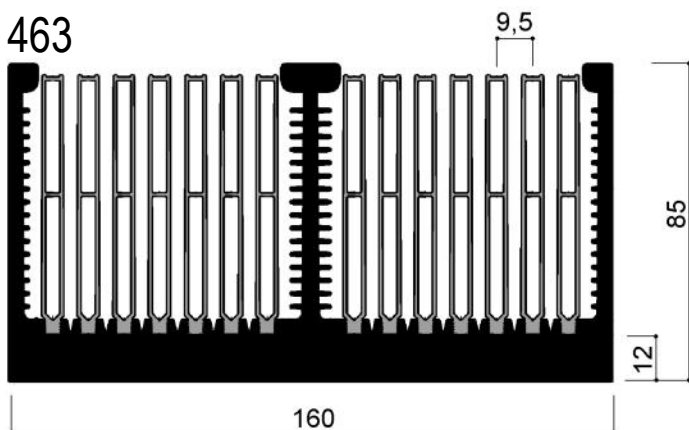

Resistenza termica (K/W) in ventilazione forzata

Lg. (mm)	100	200	300
R _{th} a 5m/s	0,082	0,065	0,05

I valori espressi dalle curve sono puramente indicativi

AGGIORNAMENTO CONTINUO - ED. DEL 03-2023

-RIPRODUZIONE VIETATA-



DISSIPATORI AD ALTO RENDIMENTO



DISEGNI META' DEL VERO (1:2)- SCALE 1:2

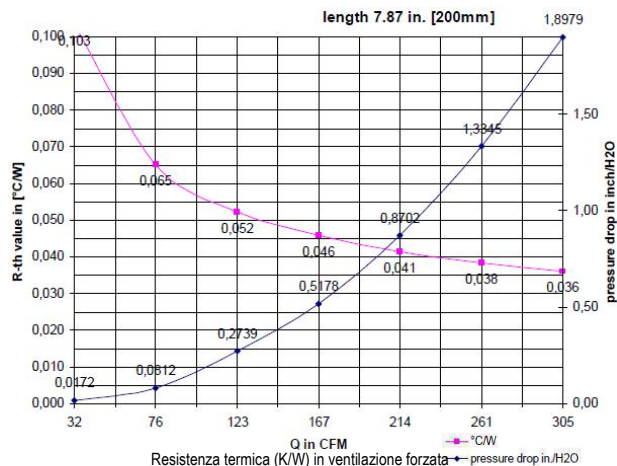
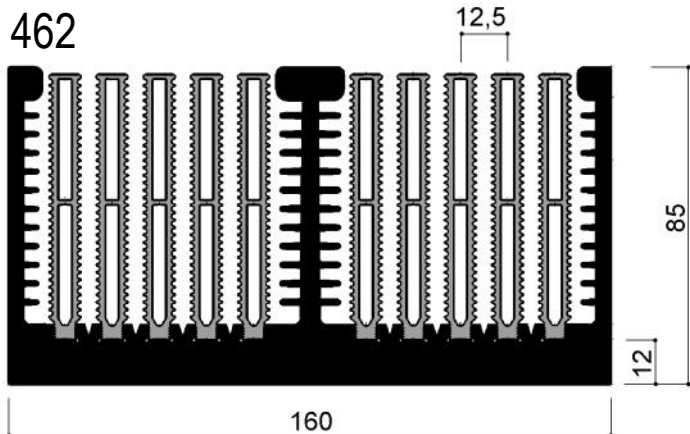

Lg. (mm)	100	200	300
R _{th} a 5m/s	0,082	0,065	0,05

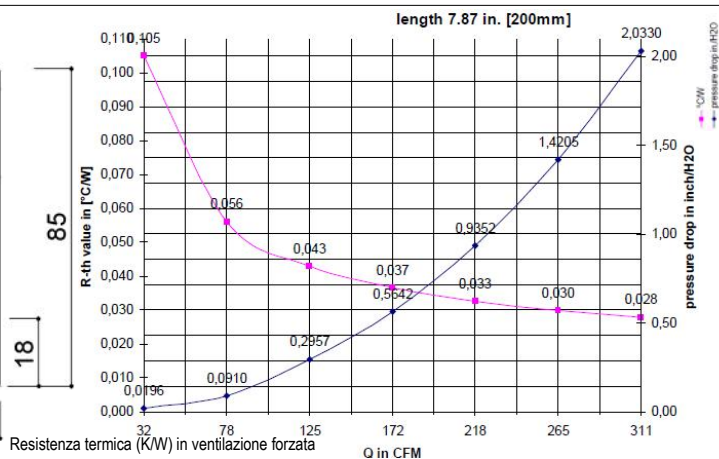
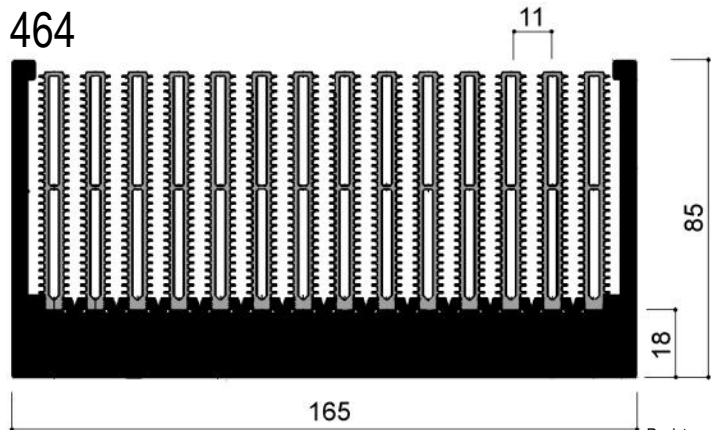

Lg. (mm)	100	200	300
R _{th} a 5m/s	0,077	0,056	0,048



FOTO DI ESEMPIO: TAGLIO A MISURA DISSIPATORI AD ALTO RENDIMENTO DI GROSSE DIMENSIONI

Via Newton, n.12
20016 Pero (Milano - Italy)
Tel.+39 02 3535955 r.a. Fax.+39 02 3539929
E-Mail: info@omar-alluminio.it

Cataloghi Online: www.omar-alluminio.it
www.omar-alluminio.com
PROFILATI ALLUMINIO A DISEGNO / STANDARD / SPECIALI / E PER:
ELETTRONICA / LED / FOTOVOLTAICO / AUTOMAZIONE ROBOTICA / PNEUMATICA / AUTOMOTIVE

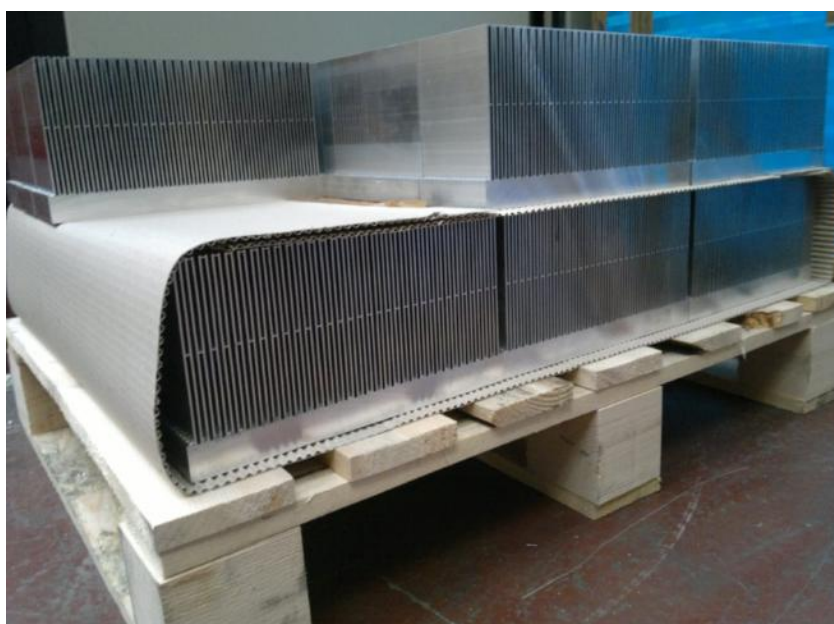

DISSIPATORI AD ALTO RENDIMENTO

DISEGNI META' DEL VERO (1:2)- SCALE 1:2



Via Newton, n.12
20016 Pero (Milano - Italy)
Tel. +39 02 3535955 r.a. Fax. +39 02 3539929
E. Mail: info@omar-alluminio.it

Cataloghi Online: www.omar-alluminio.it
www.omar-alluminio.com
PROFILATI ALLUMINIO A DISEGNO / STANDARD / SPECIALI / E PER:
ELETTRONICA / LED / FOTOVOLTAICO / AUTOMAZIONE ROBOTICA / PNEUMATICA / AUTOMOTIVE

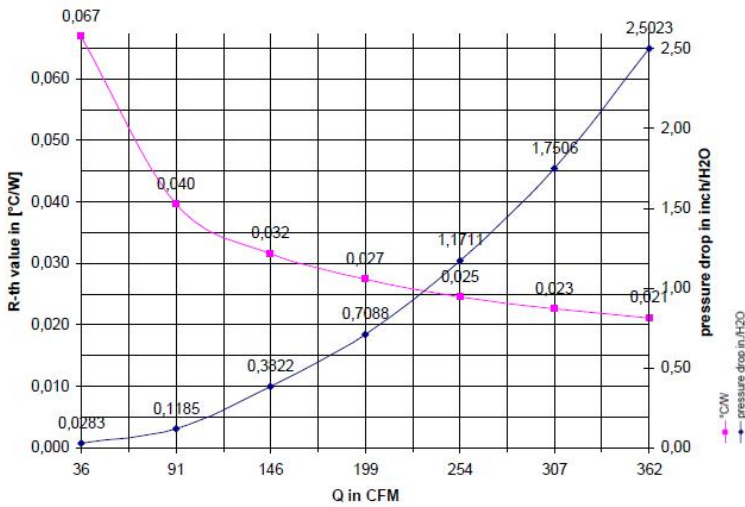
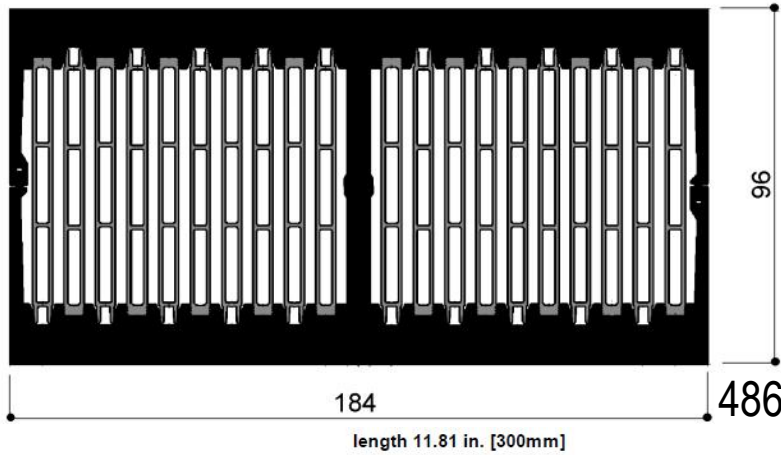

Resistenza termica (K/W) in ventilazione forzata

Lg. (mm)	100	200	300
R _{th} 5m/s	0,065	0,05	0,04



FOTO DI ESEMPIO: SI ESEGUONO OPERAZIONI DI TRANCIATURA SU PROFILI ESTRUSI IN ALLUMINIO

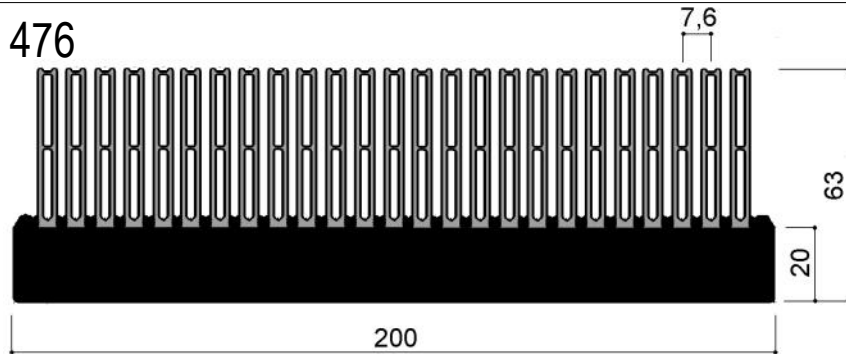

Resistenza termica (K/W) in ventilazione forzata

Lg. (mm)	100	200	300
R _{th} a 11 m/s	0,0617	0,042	0,034

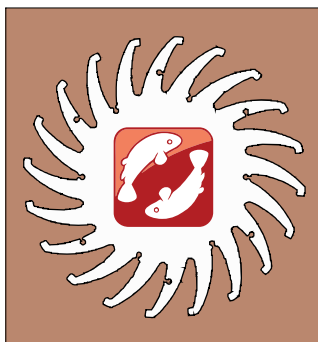
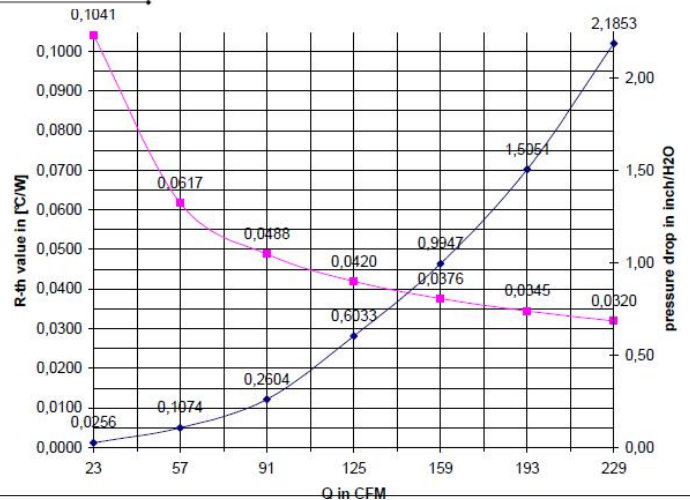

DISSIPATORI AD ALTO RENDIMENTO



DISEGNI META' DEL VERO (1:2)- SCALE 1:2

475

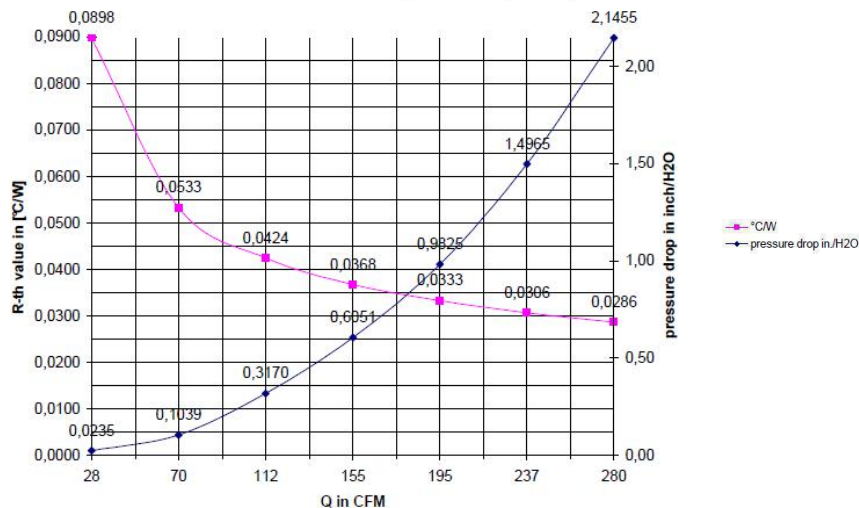
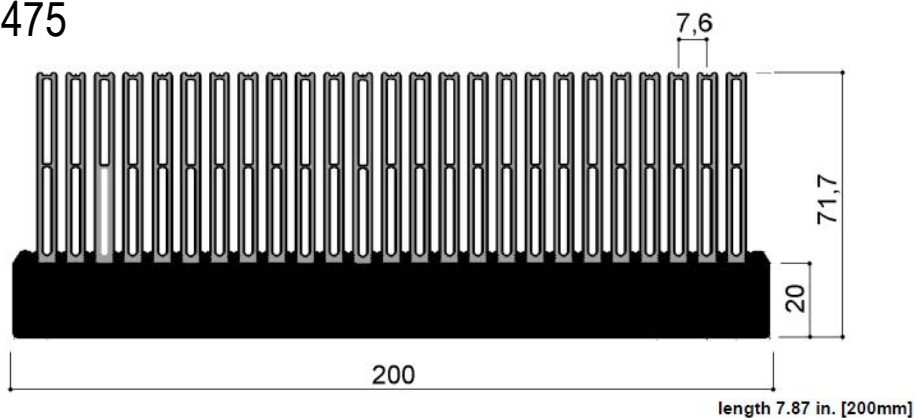

455



FOTO DI ESEMPIO: SI ESEGUONO LAVORAZIONI MECCANICHE SU PROFILI ESTRUSI IN ALLUMINIO

Via Newton, n.12
20016 Pero (Milano - Italy)
Tel. +39 02 3535955 r.a. Fax. +39 02 3539929
E-Mail: info@omar-alluminio.it

Cataloghi Online: www.omar-alluminio.it
www.omar-alluminio.com

PROFILATI ALLUMINIO A DISEGNO / STANDARD / SPECIALI / E PER:
ELETTRONICA / LED / FOTOVOLTAICO / AUTOMAZIONE ROBOTICA / PNEUMATICA / AUTOMOTIVE

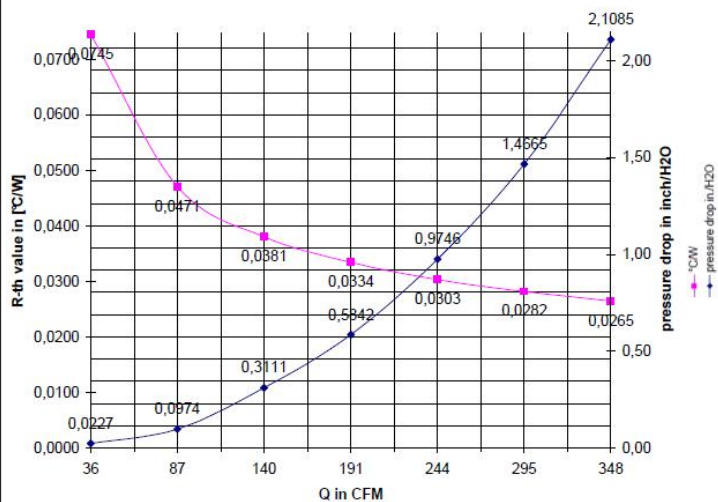
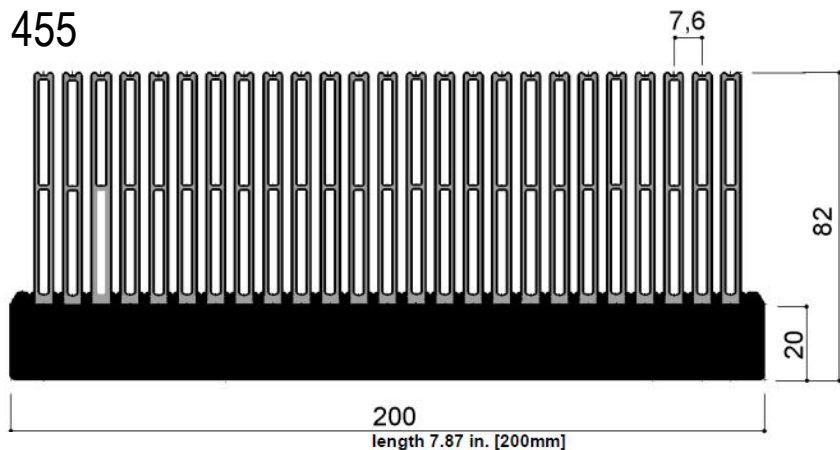

DISSIPATORI AD ALTO RENDIMENTO



DISEGNI META' DEL VERO (1:2)- SCALE 1:2

Via Newton, n.12
20016 Pero (Milano - Italy)
Tel. +39 02 3535955 r.a. Fax. +39 02 3539929
E. Mail: info@omar-alluminio.it

Cataloghi Online: www.omar-alluminio.it
www.omar-alluminio.com
PROFILATI ALLUMINIO A DISEGNO / STANDARD / SPECIALI / E PER:
ELETTRONICA / LED / FOTOVOLTAICO / AUTOMAZIONE ROBOTICA / PNEUMATICA / AUTOMOTIVE

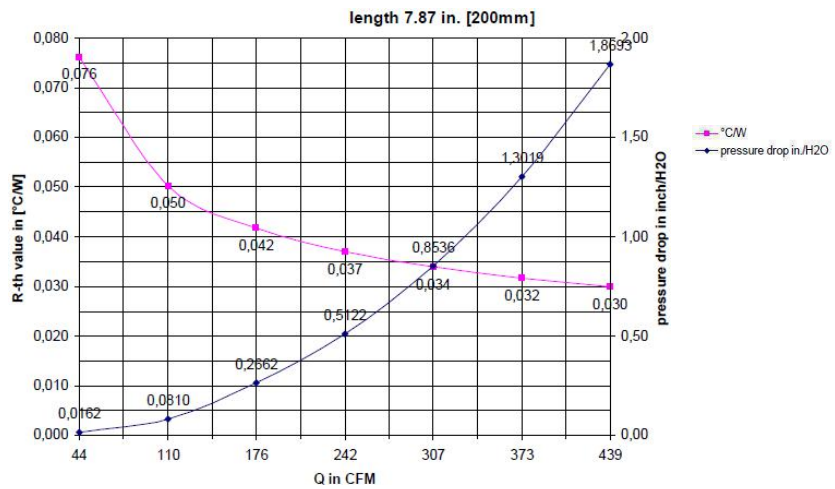
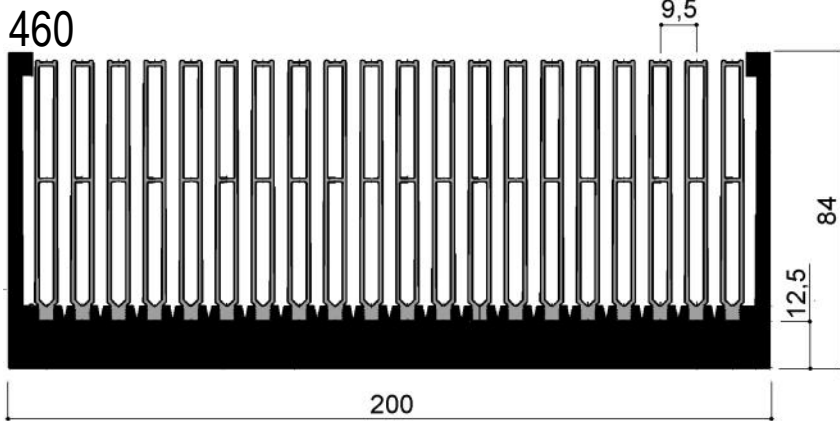
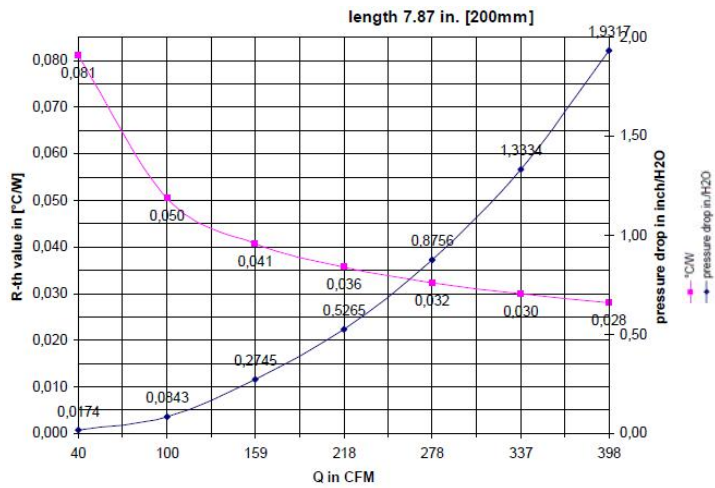
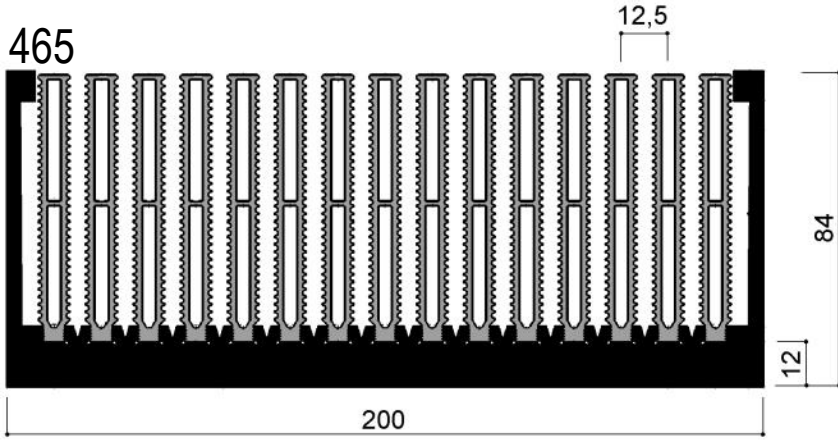

DISSIPATORI AD ALTO RENDIMENTO

DISEGNI META' DEL VERO (1:2)- SCALE 1:2

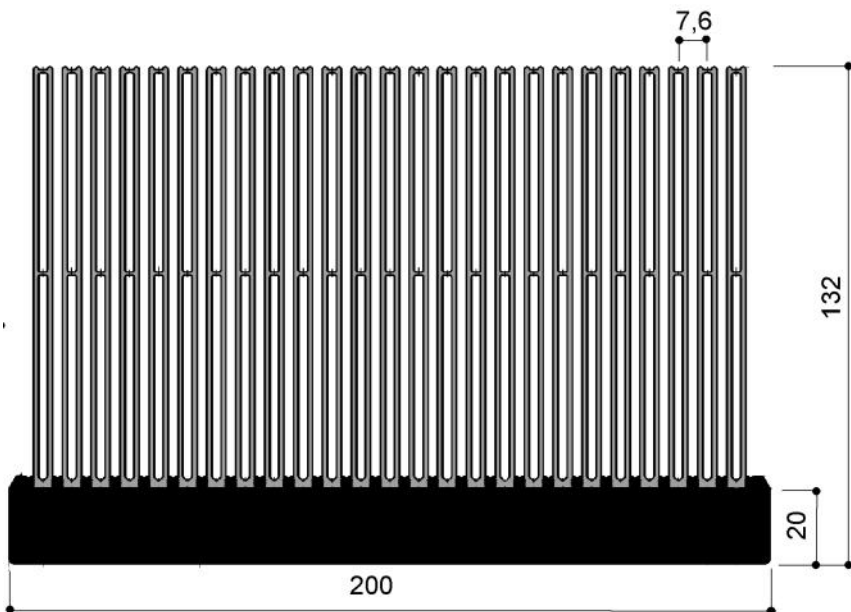

480

Resistenza termica (K/W) in ventilazione forzata

Lg. (mm)	200	300	400
Rth 5m/s	0,0414	0,0254	0,0193

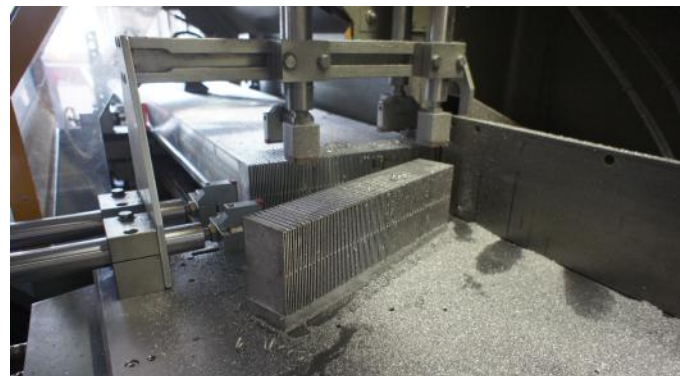
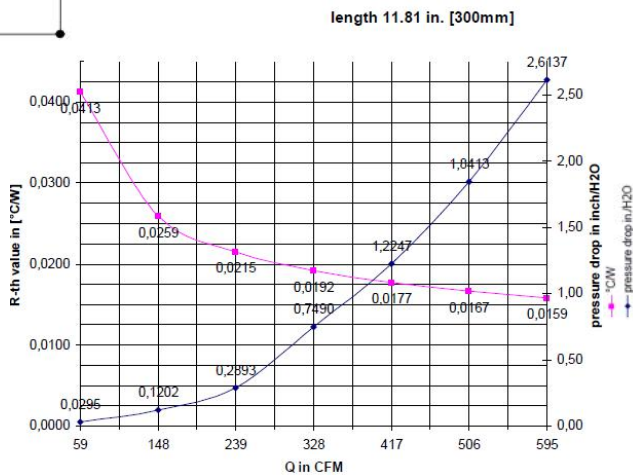

N.3 LINEE DI TAGLIO:SI ESEGUONO TAGLI SU PROFILI IN ALLUMINIO ANCHE DI GRANDI DIMENSIONI

Via Newton, n.12
20016 Pero (Milano - Italy)
Tel. +39 02 3535955 r.a. Fax. +39 02 3539929
E-Mail: info@omar-alluminio.it

Cataloghi Online: www.omar-alluminio.it
www.omar-alluminio.com
PROFILATI ALLUMINIO A DISEGNO / STANDARD / SPECIALI / E PER:
ELETTRONICA / LED / FOTOVOLTAICO / AUTOMAZIONE ROBOTICA / PNEUMATICA / AUTOMOTIVE



DISSIPATORI AD ALTO RENDIMENTO

DISEGNI META' DEL VERO (1:2)- SCALE 1:2

Via Newton, n.12
20016 Pero (Milano - Italy)
Tel. +39 02 3535955 r.a. Fax. +39 02 3539929
E. Mail: info@omar-alluminio.it

Cataloghi Online: www.omar-alluminio.it
www.omar-alluminio.com

PROFILATI ALLUMINIO A DISEGNO / STANDARD / SPECIALI / E PER:
ELETTRONICA / LED / FOTOVOLTAICO / AUTOMAZIONE ROBOTICA / PNEUMATICA / AUTOMOTIVE

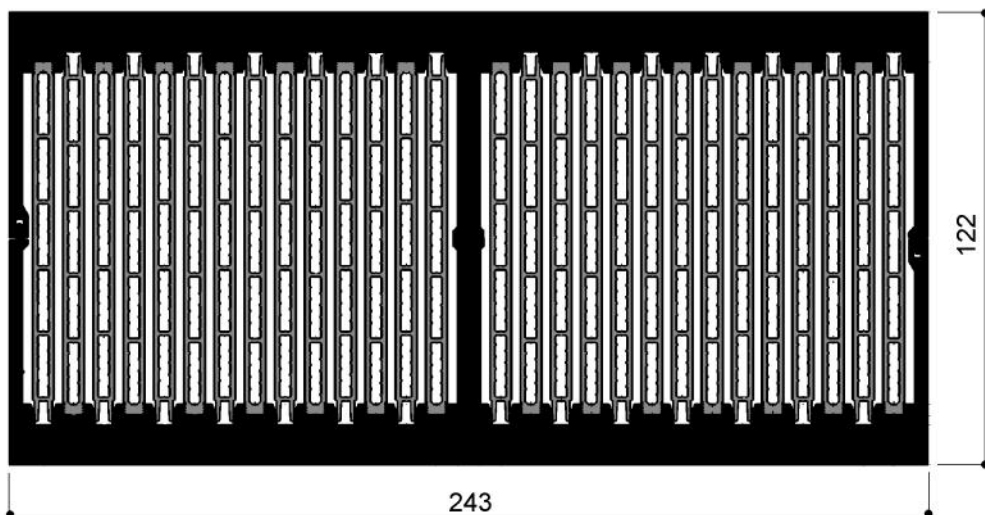

487

length 11.81 in. [300mm]

Resistenza termica (K/W) in ventilazione forzata

Lg. (mm)	100	200	300
Rth 5m/s	0,041	0,034	0,026

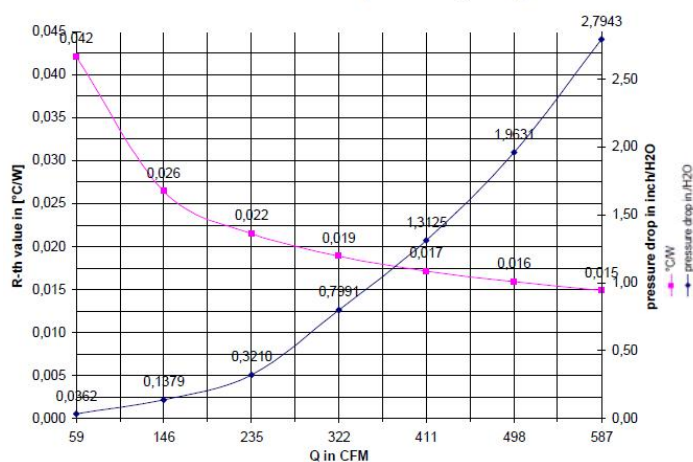

484

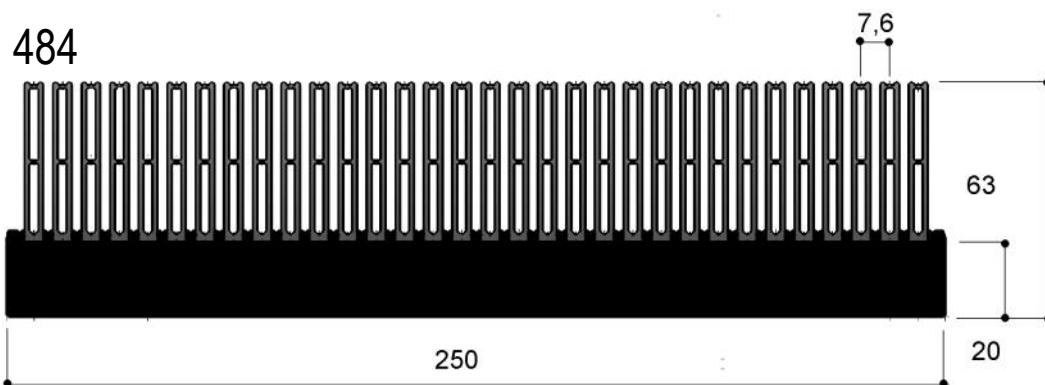

length 11.81 in. [300mm]

Resistenza termica (K/W) in ventilazione forzata

Lg. (mm)	100	200	300
Rth 11m/s	0,0480	0,0328	0,0265

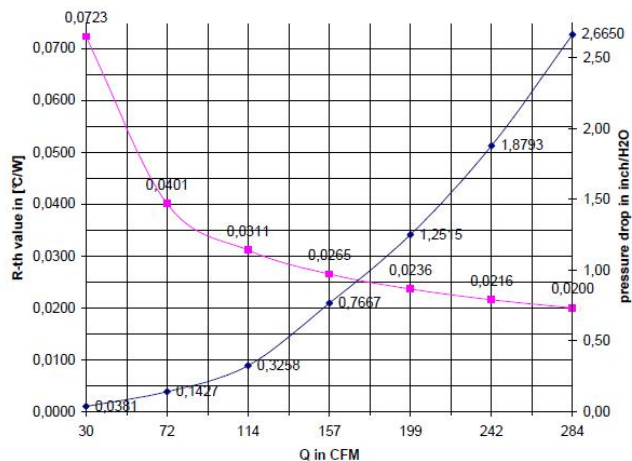

DISSIPATORI AD ALTO RENDIMENTO



DISEGNI META' DEL VERO (1:2) - SCALE 1:2

483

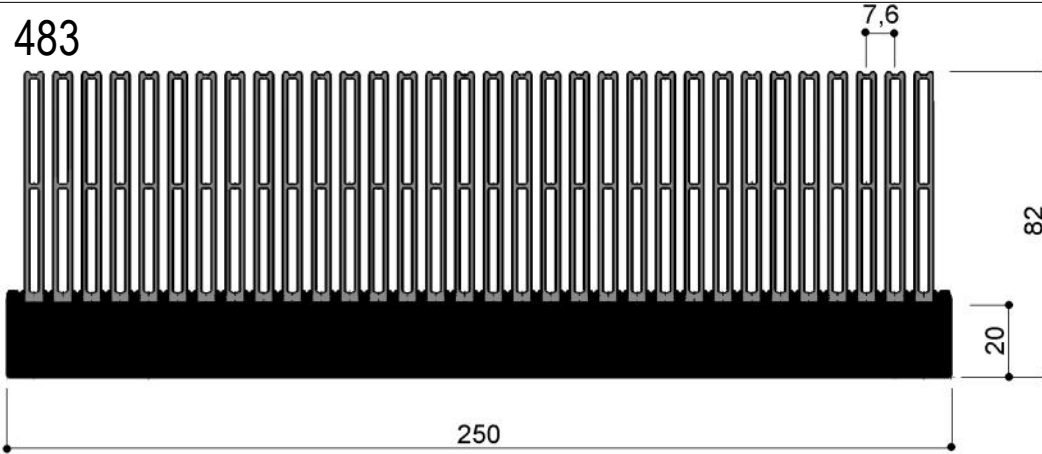

Resistenza termica (K/W) in ventilazione forzata

Lg. (mm)	100	200	300
Rm 11m/s	0,0400	0,0261	0,0207

length 11.81 in. [300mm]

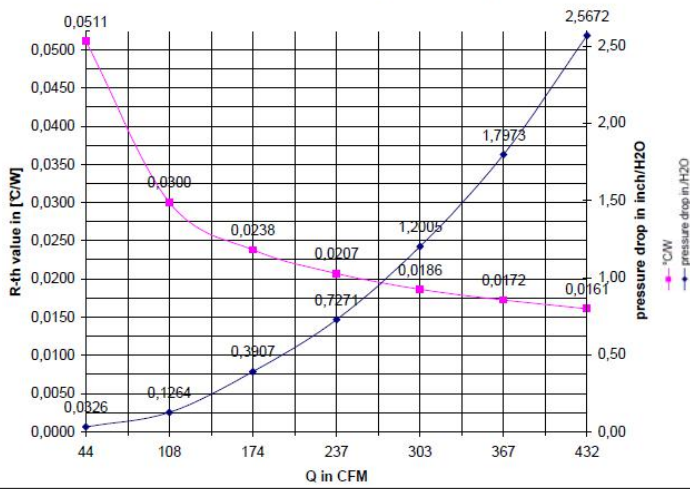

489

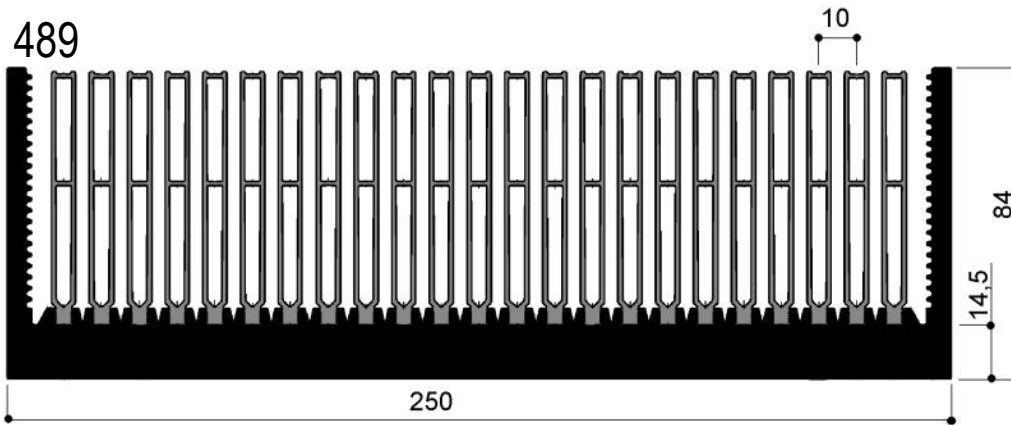

Resistenza termica (K/W) in ventilazione forzata

Lg. (mm)	100	200	300	400
Rm5/s	0,0663	0,0438	0,0349	0,0300

length 15.74 in. [400mm]

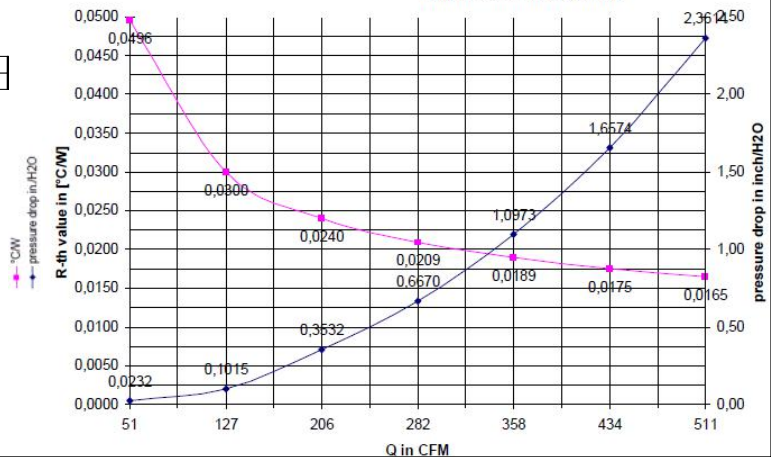

Via Newton, n.12
20016 Pero (Milano - Italy)
Tel. +39 02 3535955 r.a. Fax. +39 02 3539929
E-Mail: info@omar-alluminio.it

Cataloghi Online: www.omar-alluminio.it
www.omar-alluminio.com

PROFILATI ALLUMINIO A DISEGNO / STANDARD / SPECIALI / E PER:
ELETTRONICA / LED / FOTOVOLTAICO / AUTOMAZIONE ROBOTICA / PNEUMATICA / AUTOMOTIVE



DISSIPATORI AD ALTO RENDIMENTO



Via Newton, n.12
20016 Pero (Milano - Italy)
Tel. +39 02 3535955 r.a. Fax. +39 02 3539929
E-Mail: info@omar-alluminio.it

Cataloghi Online: www.omar-alluminio.it
www.omar-alluminio.com

PROFILATI ALLUMINIO A DISEGNO / STANDARD / SPECIALI / E PER:
ELETTRONICA / LED / FOTOVOLTAICO / AUTOMAZIONE ROBOTICA / PNEUMATICA / AUTOMOTIVE

DISEGNI META' DEL VERO (1:2)- SCALE 1:2

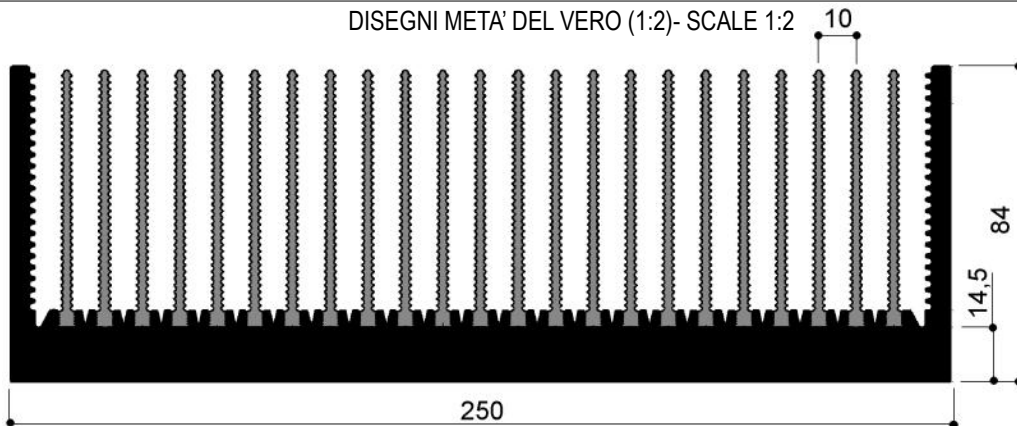

492

Resistenza termica (K/W) in ventilazione forzata

Lg. (mm)	100	200	300	400
Rth5/s	0,0963	0,0644	0,0516	0,0437

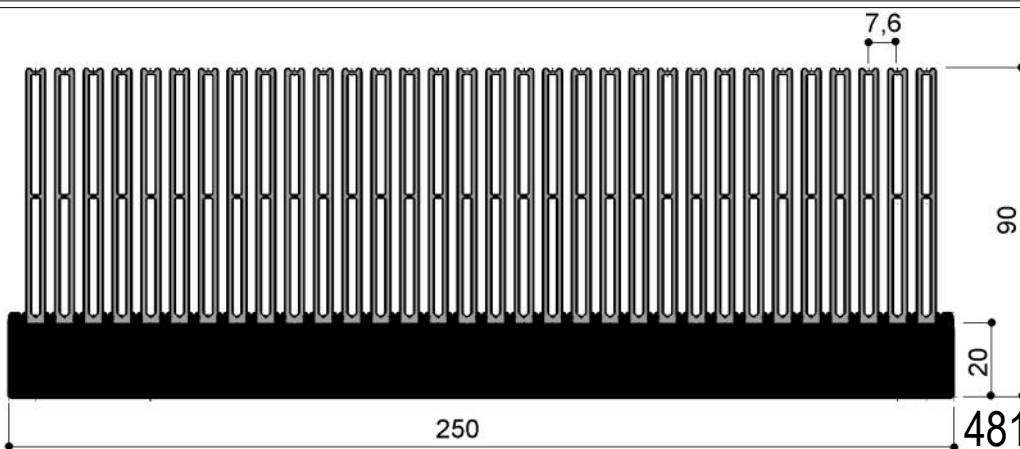
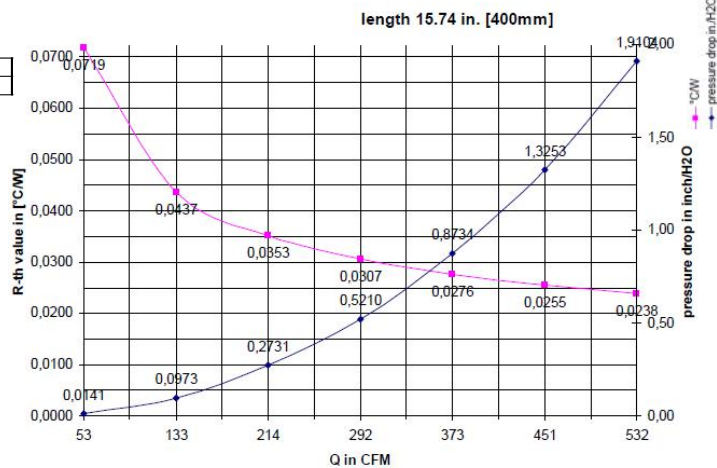

Resistenza termica (K/W) in ventilazione forzata

Lg. (mm)	100	200	300
Rth11m/s	0,0370	0,0239	0,0188



FOTO DI ESEMPIO: DISSIPATORI "FLOWER" A STOCK IN PRONTA CONSEGNA



DISSIPATORI AD ALTO RENDIMENTO

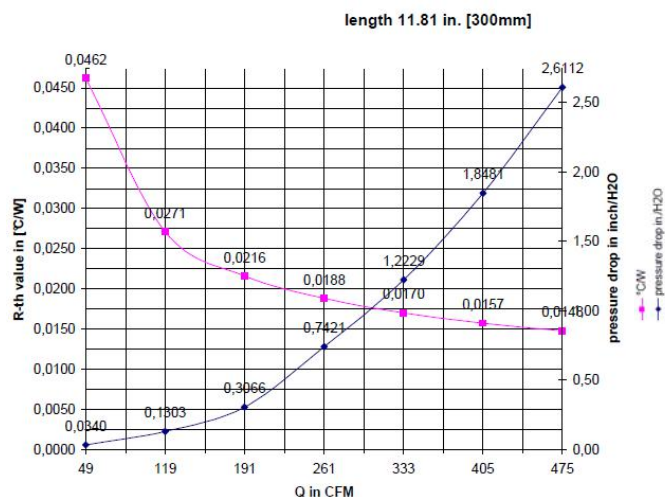

DISEGNI META' DEL VERO (1:2)- SCALE 1:2

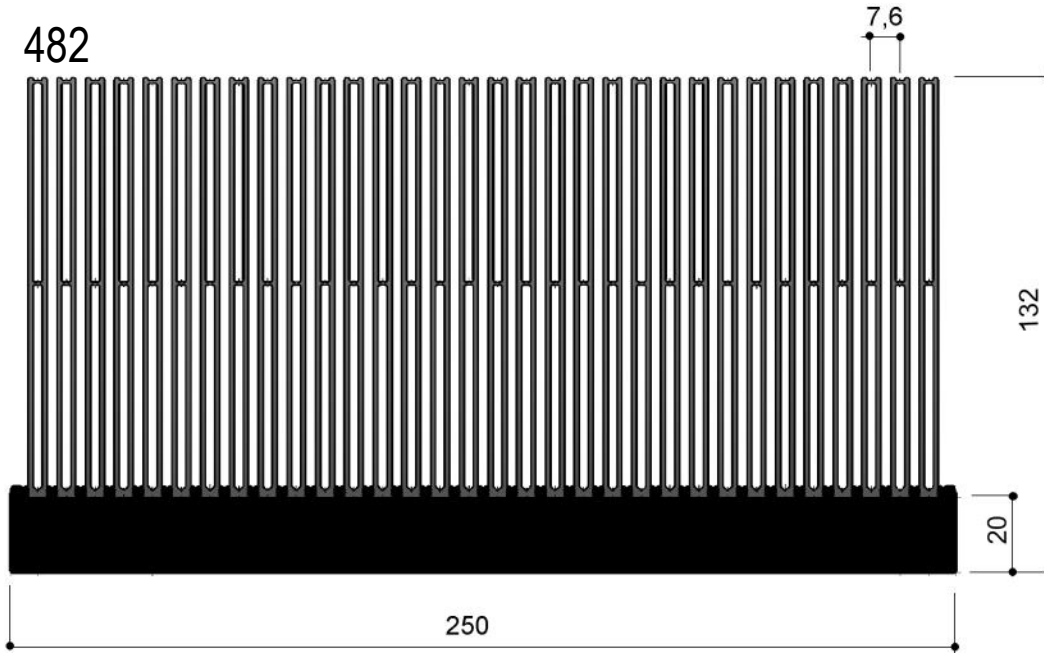

Resistenza termica (K/W) in ventilazione forzata

Lg. (mm)	100	200	300
Rm 11m/s	0,0324	0,0198	0,0151

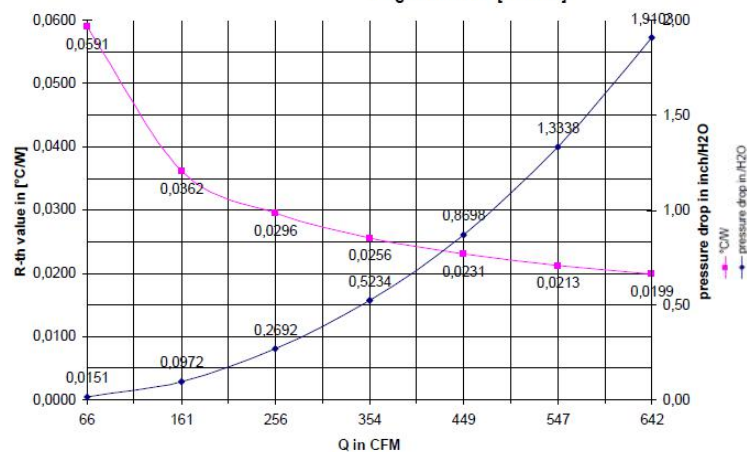
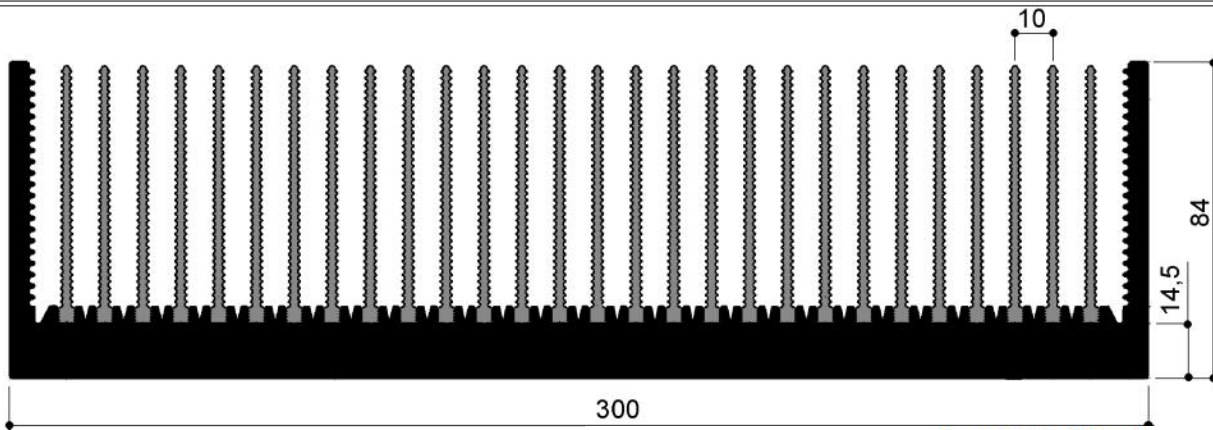
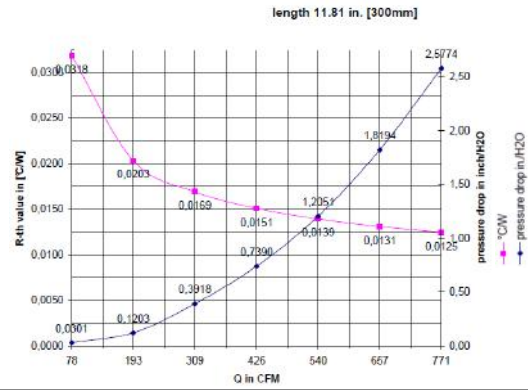

Via Newton, n.12
20016 Pero (Milano - Italy)
Tel. +39 02 3535955 r.a. Fax. +39 02 3539929
E-Mail: info@omar-alluminio.it

Cataloghi Online: www.omar-alluminio.it
www.omar-alluminio.com

PROFILATI ALLUMINIO A DISEGNO / STANDARD / SPECIALI / E PER:
ELETTRONICA / LED / FOTOVOLTAICO / AUTOMAZIONE ROBOTICA / PNEUMATICA / AUTOMOTIVE



DISSIPATORI AD ALTO RENDIMENTO



Via Newton, n.12
20016 Pero (Milano - Italy)
Tel. +39 02 3535955 r.a. Fax. +39 02 3539929
E.Mail: info@omar-alluminio.it

Cataloghi Online: www.omar-alluminio.it
www.omar-alluminio.com

PROFILATI ALLUMINIO A DISEGNO / STANDARD / SPECIALI / E PER:
ELETTRONICA / LED / FOTOVOLTAICO / AUTOMAZIONE ROBOTICA / PNEUMATICA / AUTOMOTIVE



DISEGNI FUORI SCALA

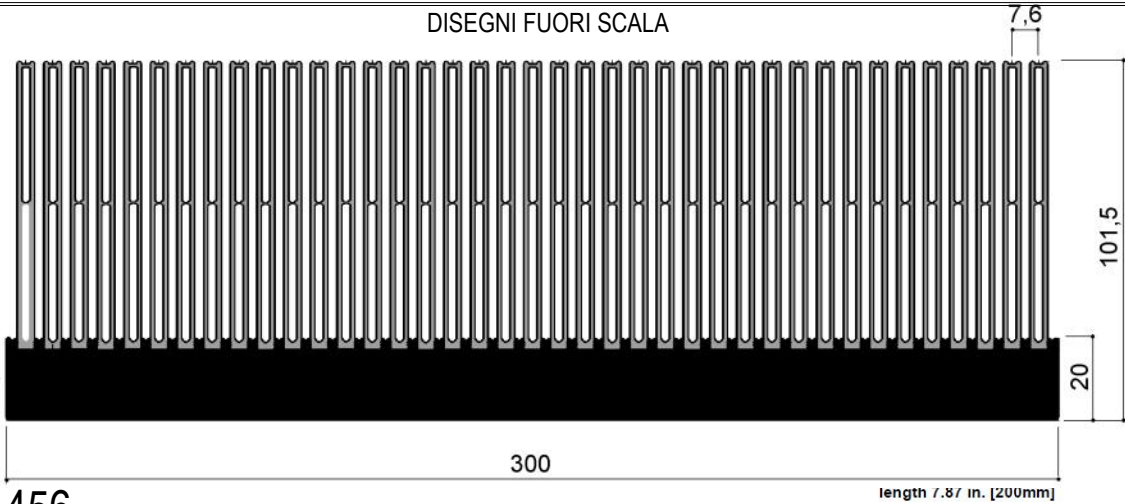

456

Resistenza termica (K/W) in ventilazione forzata

Lg. (mm)	100	200	300	400
R _{th} a 11 m/s	0,00284	0,0181	0,0141	0,119

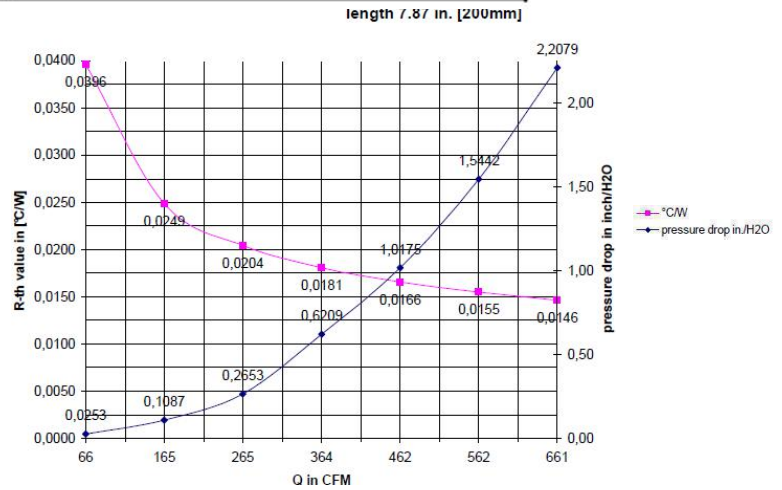

DISEGNI FUORI SCALA

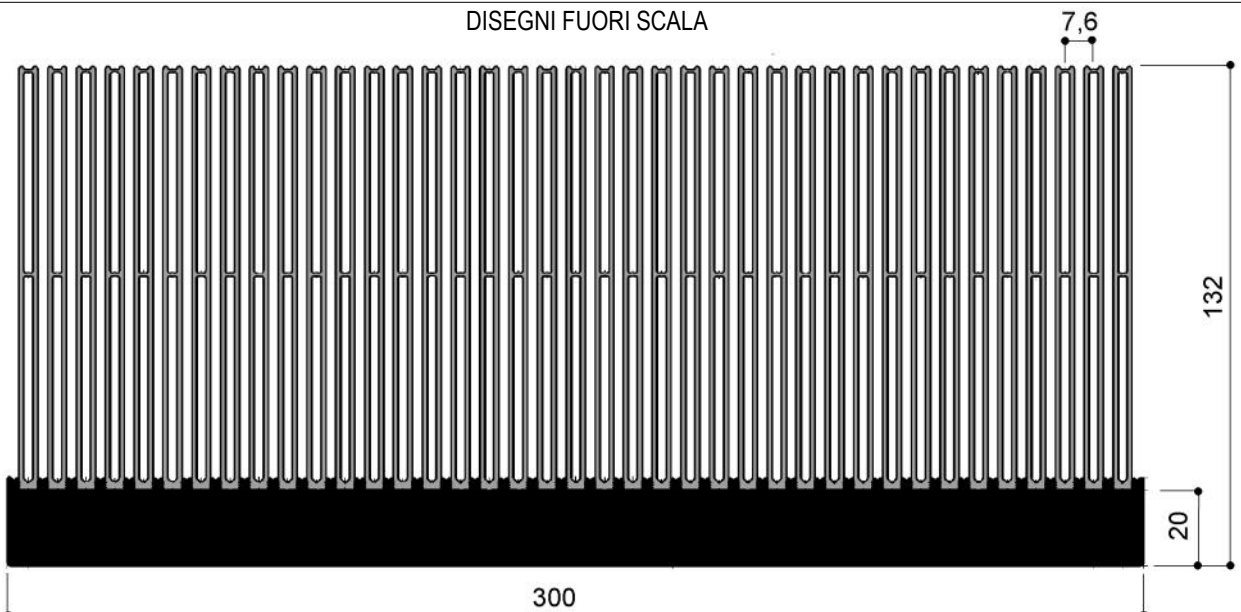

479

Resistenza termica (K/W) in ventilazione forzata

Lg. (mm)	200	300	400
R _{th} 5 m/s	0,0163	0,0124	0,0103

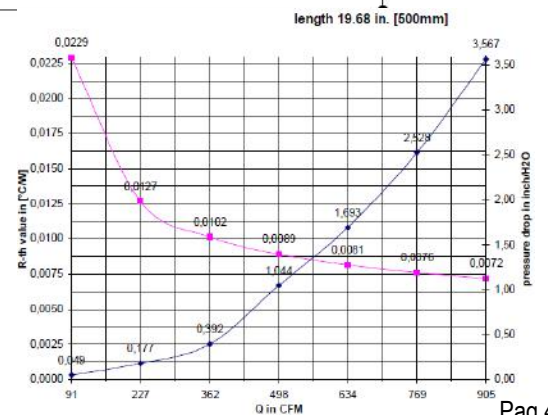

I valori espressi dalle curve sono puramente indicativi

AGGIORNAMENTO CONTINUO - ED. DEL 03-2023-RIPRODUZIONE VIETATA-

DISSIPATORI AD ALTO RENDIMENTO



DISEGNI FUORI SCALA

491

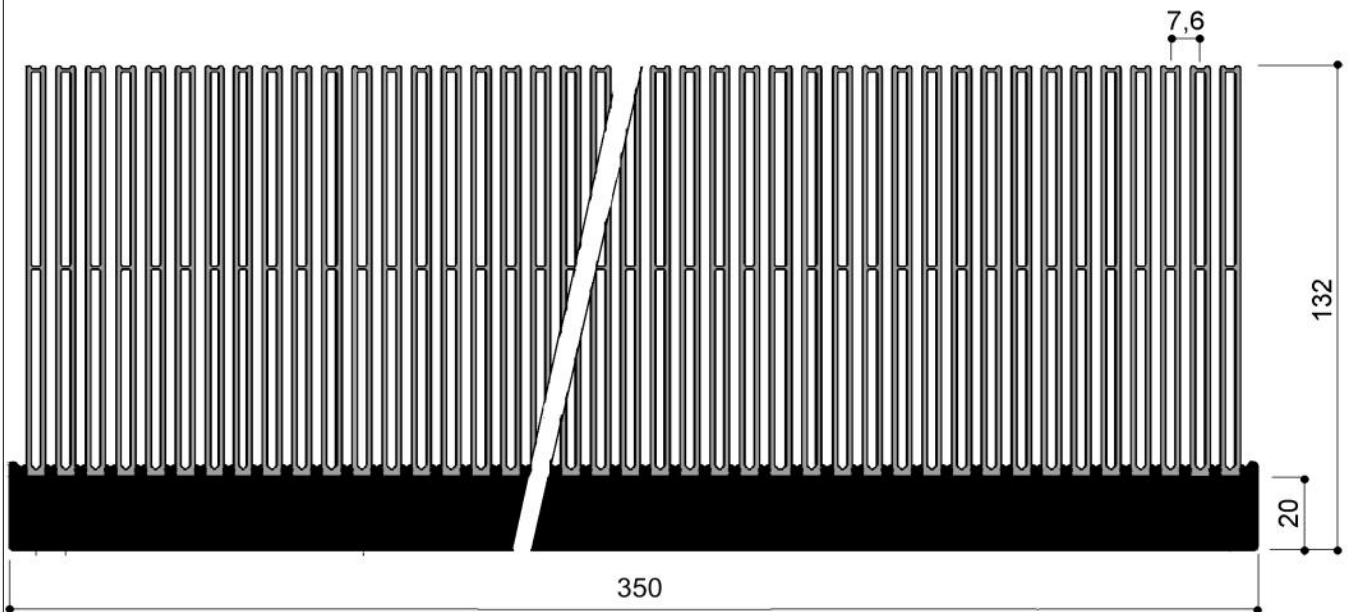
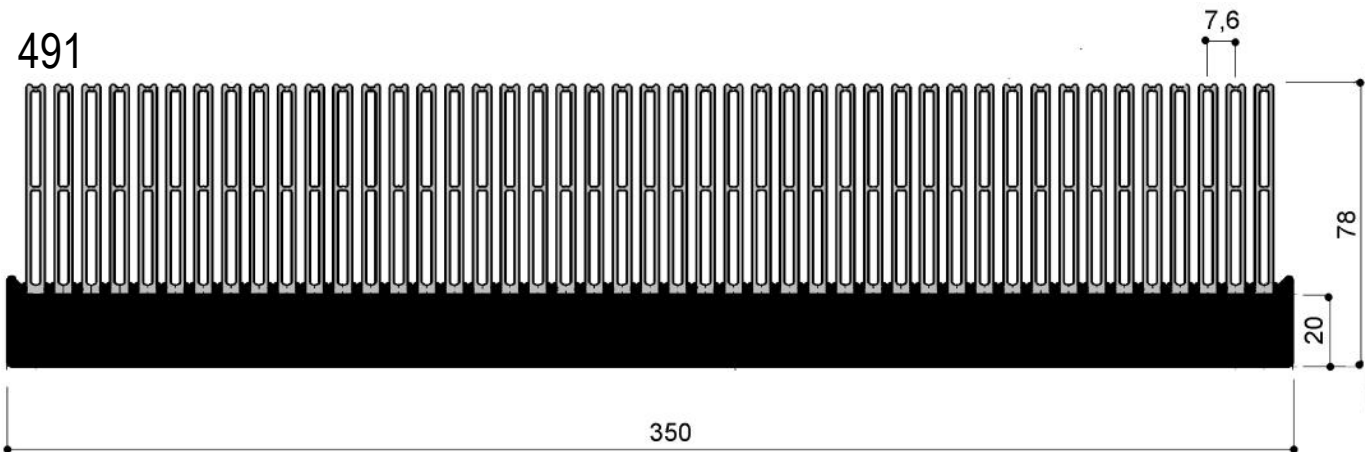

466



FOTO DI ESEMPIO: PROFILI IN ALLUMINIO CARCASSE DI MOTORI ELETTRICI TAGLIATI A MISURA STOCCATI SU PALLET, IN PRONTA CONSEGNA

Via Newton, n.12
20016 Pero (Milano - Italy)
Tel. +39 02 3535955 r.a. Fax. +39 02 3539929
E-Mail: info@omar-alluminio.it

Cataloghi Online: www.omar-alluminio.it
www.omar-alluminio.com

PROFILATI ALLUMINIO

A DISEGNO / STANDARD / SPECIALI E LORO DERIVATI



DISSIPATORI AD ALTO RENDIMENTO



Via Newton, n. 12
20016 Pero (Milano - Italy)
Tel. +39 02 3535955 r.a. Fax. +39 02 3539929
E. Mail: info@omar-alluminio.it

Cataloghi Online: www.omar-alluminio.it
www.omar-alluminio.com

PROFILATI ALLUMINIO A DISEGNO / STANDARD / SPECIALI / E PER:
ELETTRONICA / LED / FOTOVOLTAICO / AUTOMAZIONE ROBOTICA / PNEUMATICA / AUTOMOTIVE



DISEGNI FUORI SCALA

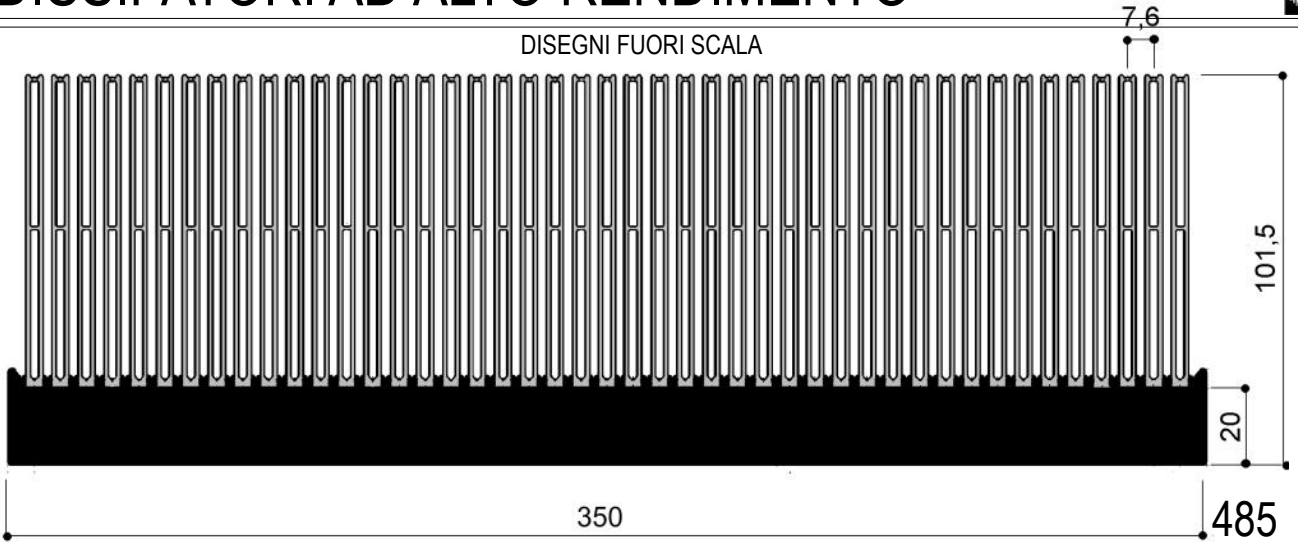

Resistenza termica (K/W) in ventilazione forzata

Lg. (mm)	200	300	400
Rth 11 m/s	0,0157	0,0122	0,0103

length 15.75 in. [400mm]



FOTO DI ESEMPIO: DISSIPATORI A VENTILAZIONE FORZATA PER 6 SCHEDE LED

DISEGNI FUORI SCALA

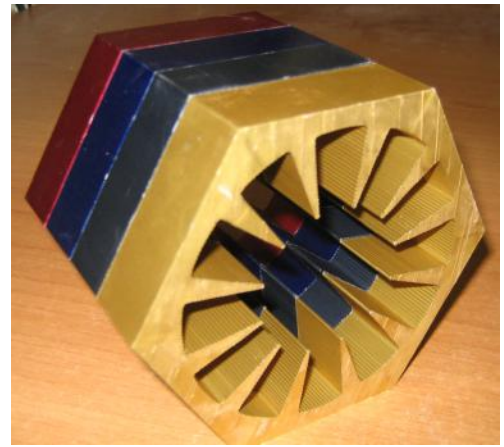
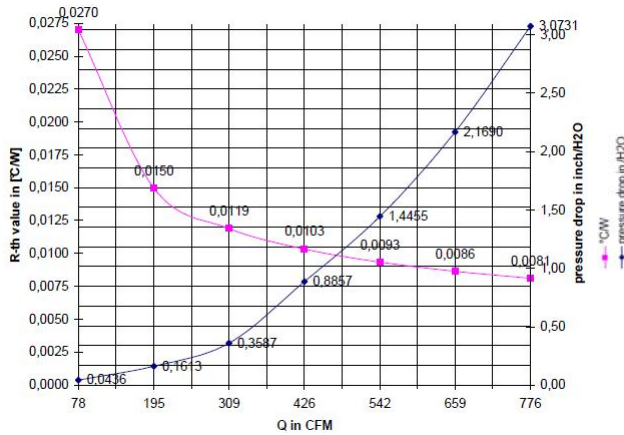
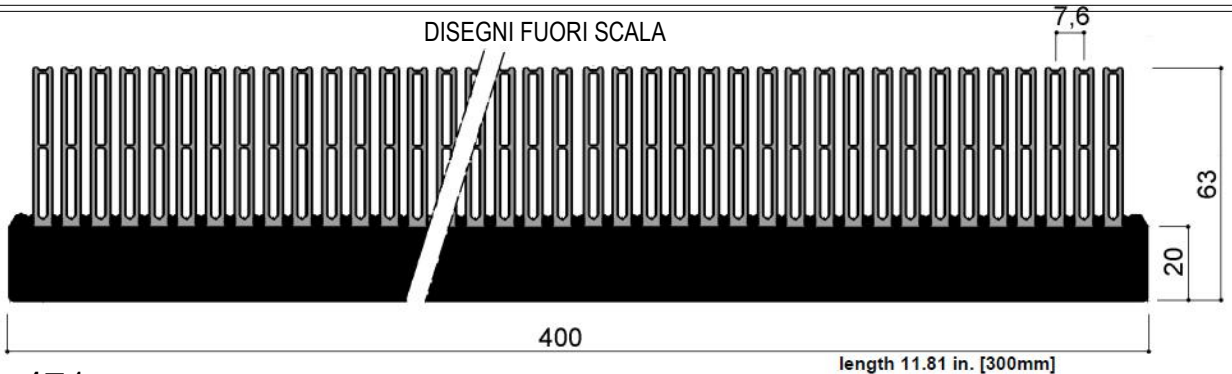

471

length 11.81 in. [300mm]

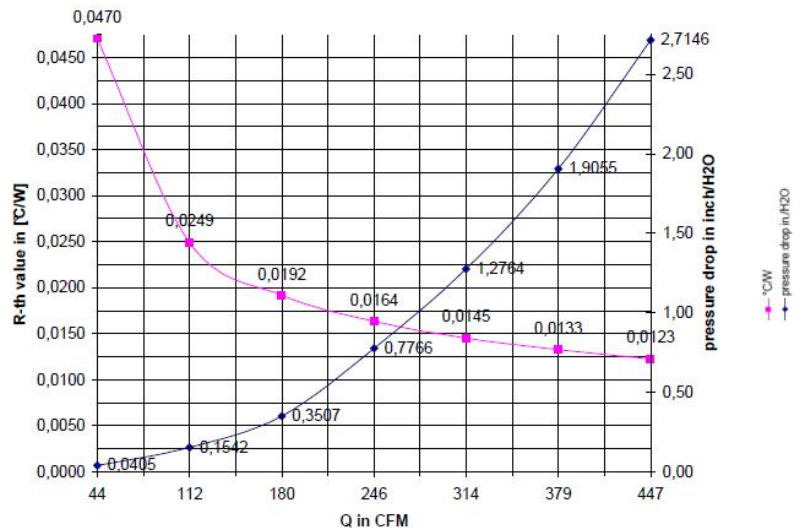

I valori espressi dalle curve sono puramente indicativi
AGGIORNAMENTO CONTINUO - ED. DEL 03-2023
-RIPRODUZIONE VIETATA-

DISSIPATORI AD ALTO RENDIMENTO



DISEGNI META' DEL VERO (1:2)- SCALE 1:2

457

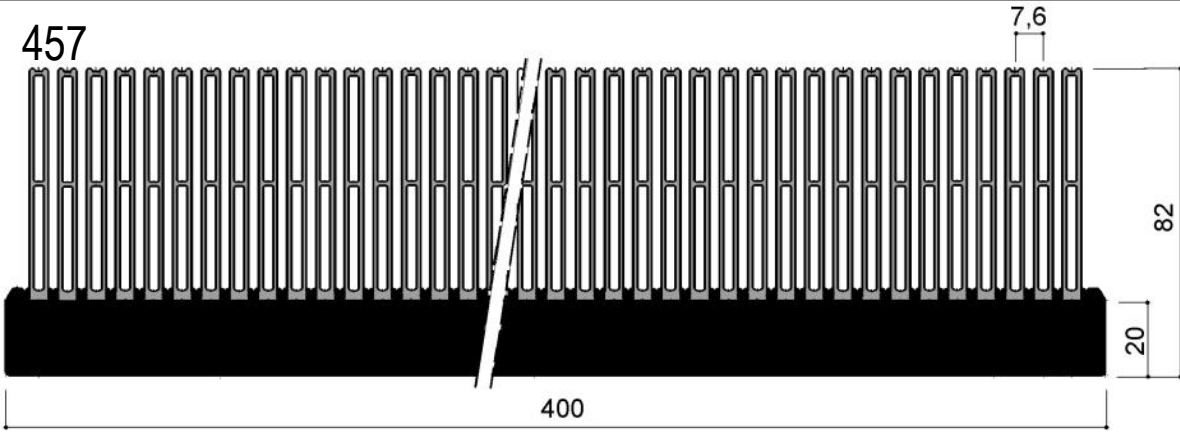

Resistenza termica (K/W) in ventilazione forzata

Lg. (mm)	200	300	400	500
R _{th} a 11m/s	0,00161	0,0128	0,0109	0,0097

length 11.81 in. [300mm]



FOTO DI ESEMPIO: TAGLIO A MISURA DI DISSIPATORI "FLOWER" ANCHE DI GROSSE DIMENSIONI

494

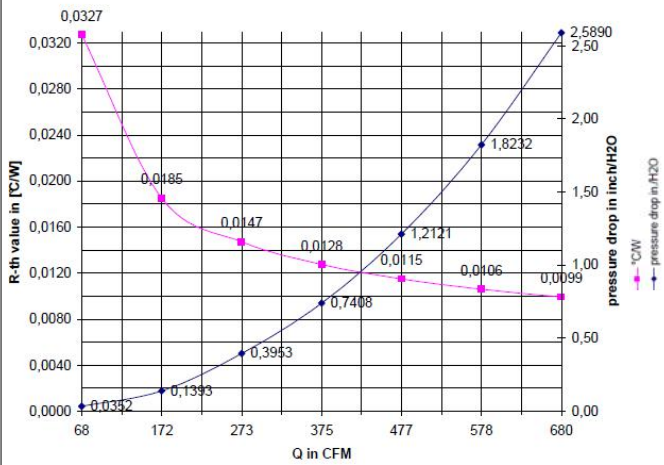
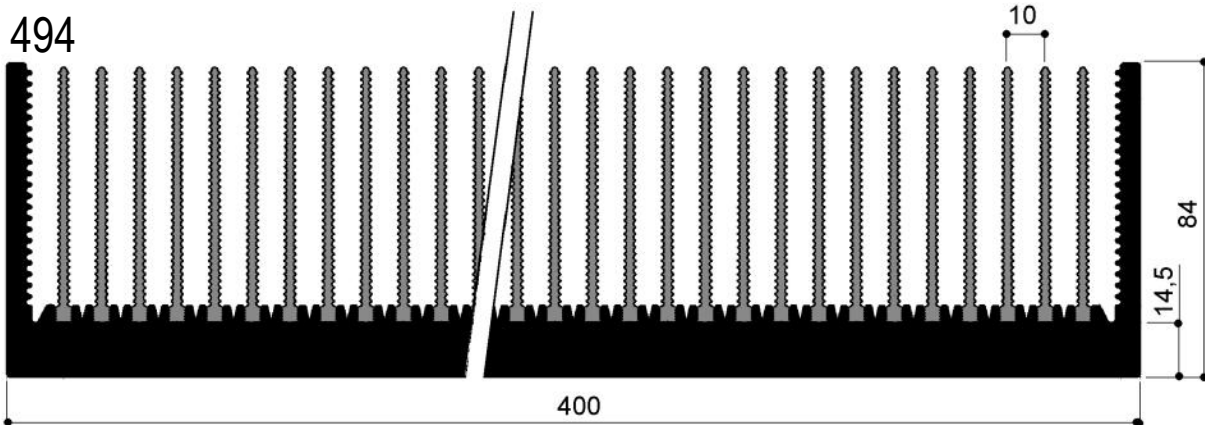

Resistenza termica (K/W) in ventilazione forzata

Lg. (mm)	100	200	300	400	500
R _{th} 5 m/s	0,0594	0,0898	0,0839	0,0270	0,0229

length 19.68 in. [500mm]

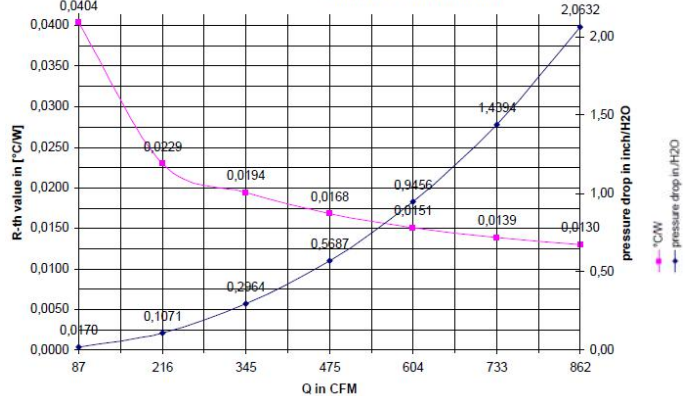

I valori espressi dalle curve sono puramente indicativi

-RIPRODUZIONE VIETATA- AGGIORNAMENTO CONTINUO - ED. DEL 03-2023

Via Newton, n.12
20016 Pero (Milano - Italy)
Tel.+39 02 3535955 r.a. Fax.+39 02 3539929
E-Mail: info@omar-alluminio.it

Cataloghi Online: www.omar-alluminio.it
www.omar-alluminio.com

PROFILATI ALLUMINIO
A DISEGNO / STANDARD / SPECIALI E LORO DERIVATI



DISSIPATORI AD ALTO RENDIMENTO



DISEGNI META' DEL VERO (1:2)- SCALE 1:2

Via Newton, n.12
20016 Pero (Milano - Italy)
Tel. +39 02 3535955 r.a. Fax. +39 02 3539929
E. Mail: info@omar-alluminio.it

Cataloghi Online: www.omar-alluminio.it
www.omar-alluminio.com

PROFILATI ALLUMINIO A DISEGNO / STANDARD / SPECIALI / E PER:
ELETTRONICA / LED / FOTOVOLTAICO / AUTOMAZIONE ROBOTICA / PNEUMATICA / AUTOMOTIVE

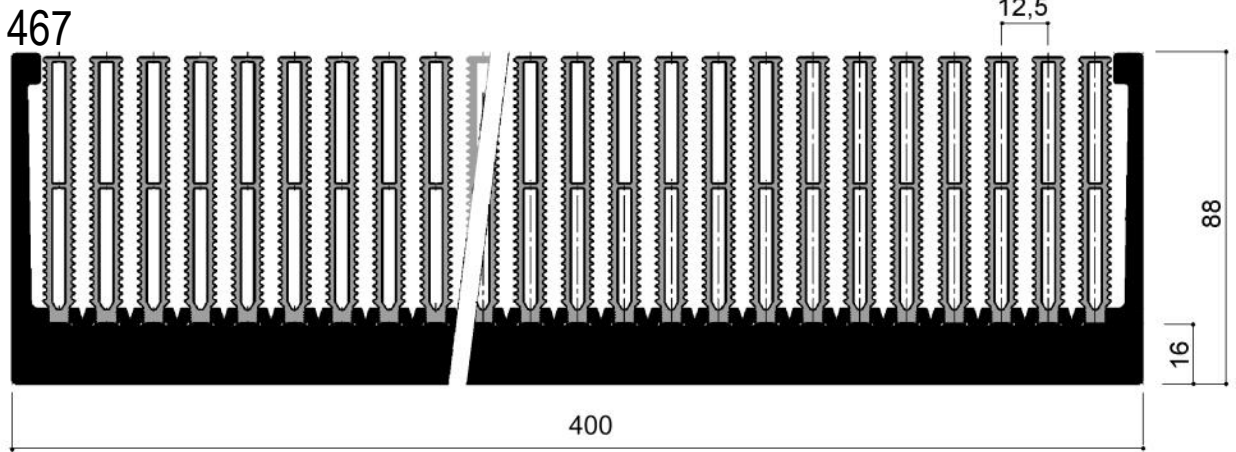

Resistenza termica (K/W) in ventilazione forzata

Lg. (mm)	100	200	300
R _{th} a 5m/s	0,036	0,026	0,019

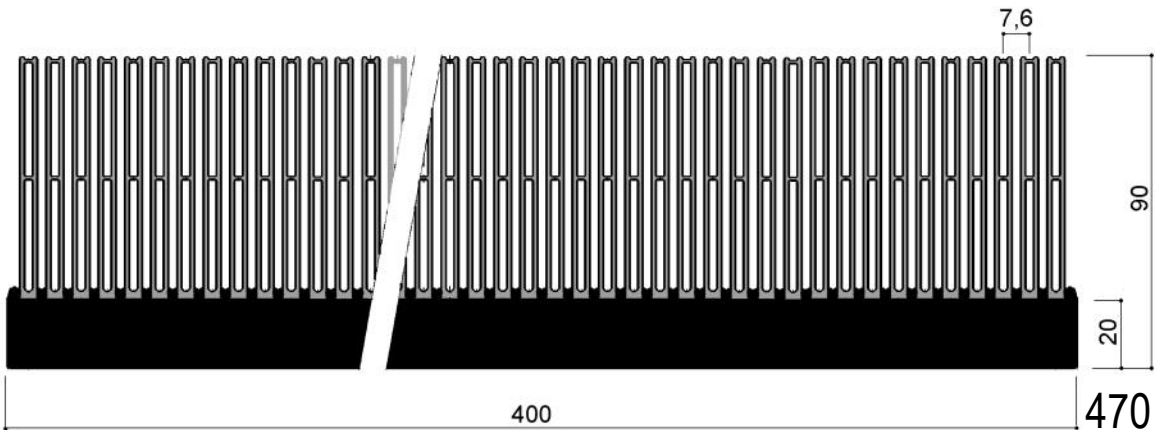
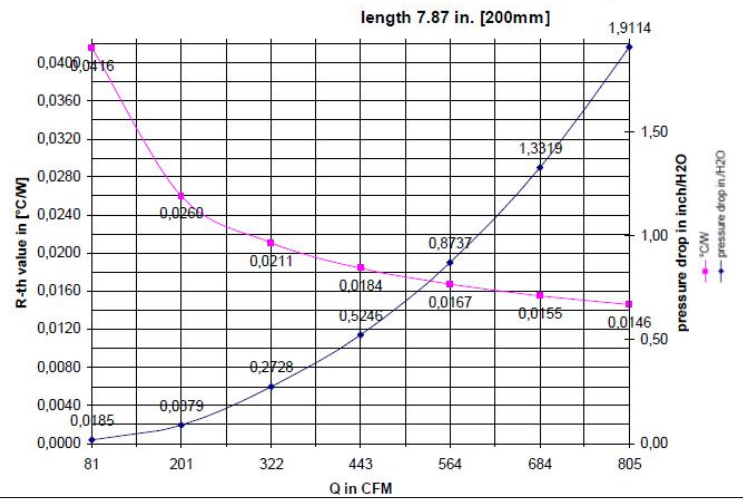

Resistenza termica (K/W) in ventilazione forzata

Lg. (mm)	200	300	400	500
R _{th} a 11m/s	0,0145	0,0115	0,0098	0,0087

length 11.81 in. [300mm]



FOTO DI ESEMPIO: TAGLIO PROFILO IN ALLUMINIO ESTRUSO PER LED DI GROSSE DIMENSIONI



DISSIPATORI AD ALTO RENDIMENTO

Disegni Meta' del Vero (1:2) - Scale 1:2

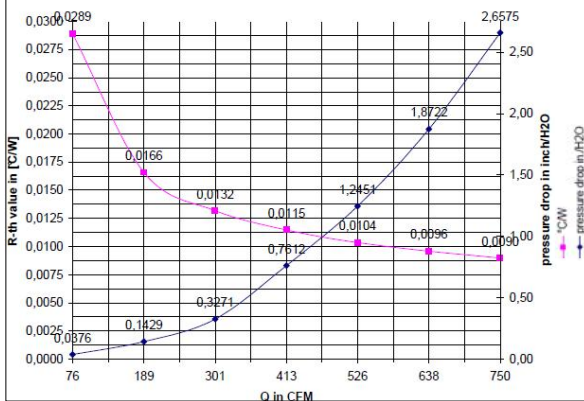
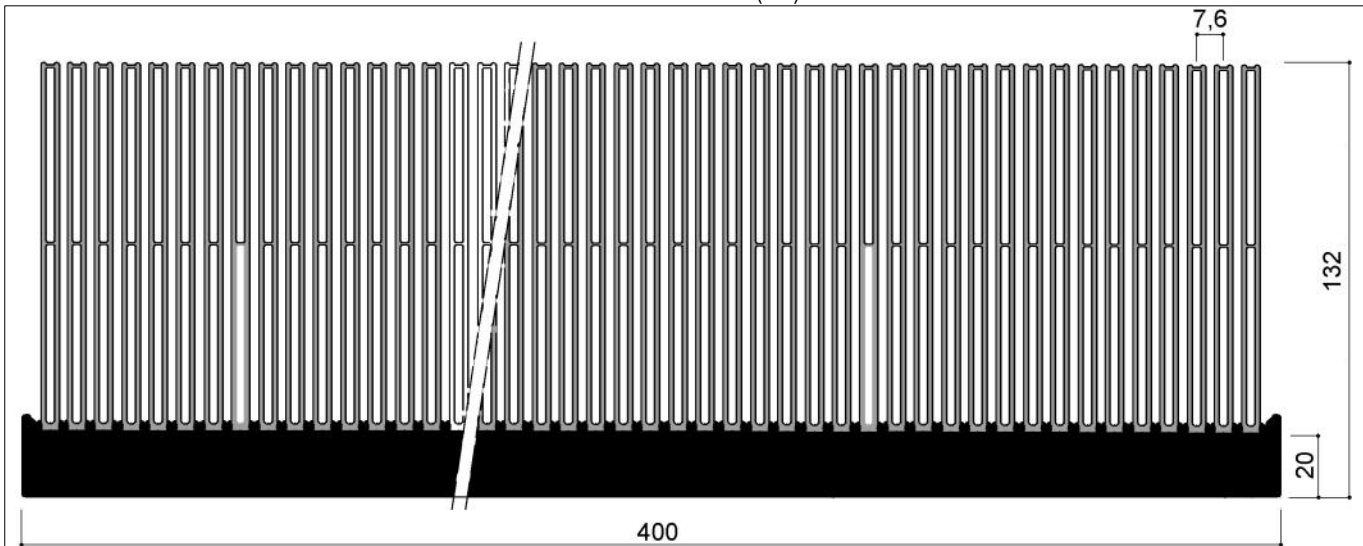

474

400

length 11.81 in. [300mm]

132

20

Resistenza termica (KW) in ventilazione forzata

Lg. (mm)	200	300	400	500
R _{th} a 5m/s	0,0121	0,0092	0,0077	0,0067

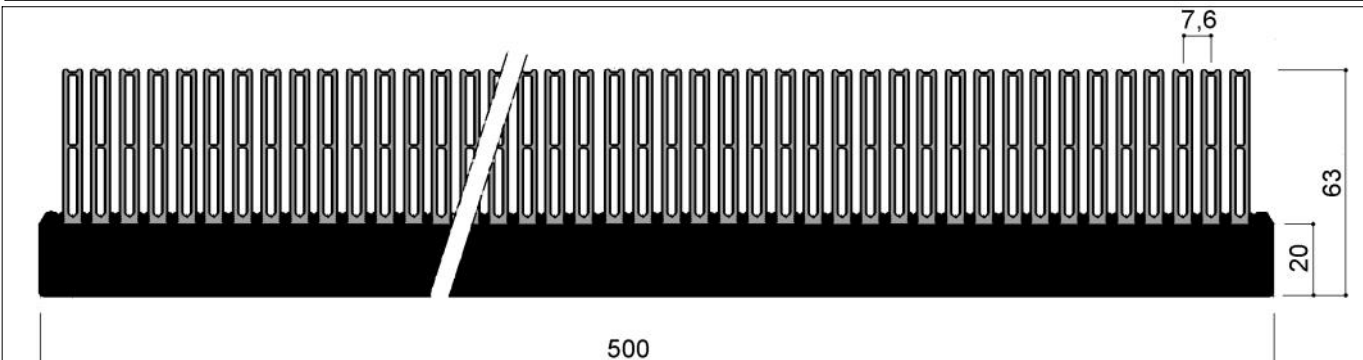
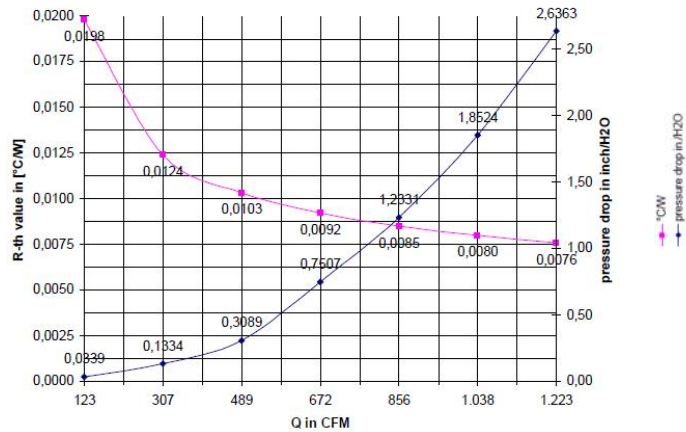

472

500

length 15.74 in. [400mm]

63

20

Resistenza termica (KW) in ventilazione forzata

Lg. (mm)	200	300	400	500
R _{th} a 11m/s	0,0162	0,0131	0,0114	0,0103

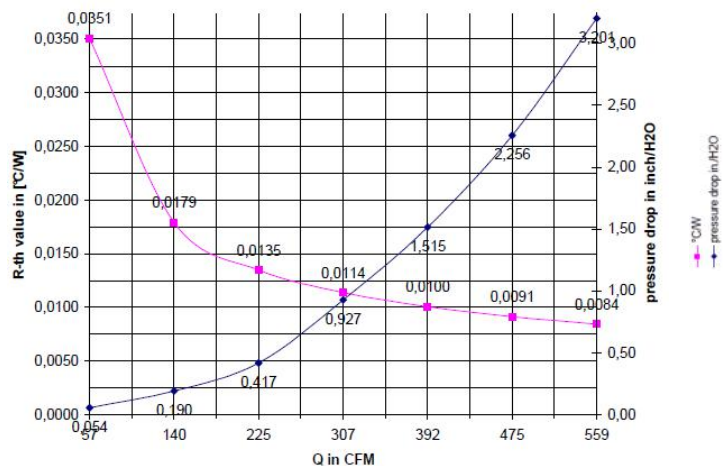

Via Newton, n.12
20016 Pero (Milano - Italy)
Tel. +39 02 3535955 r.a. Fax. +39 02 3539929
E-Mail: info@omar-alluminio.it

Cataloghi Online: www.omar-alluminio.it

www.omar-alluminio.com

PROFILATI ALLUMINIO A DISEGNO / STANDARD / SPECIALI / E PER:

ELETTRONICA / LED / FOTOVOLTAICO / AUTOMAZIONE ROBOTICA / PNEUMATICA / AUTOMOTIVE



DISSIPATORI AD ALTO RENDIMENTO



DISEGNI META' DEL VERO (1:2)- SCALE 1:2

Via Newton, n.12
20016 Pero (Milano - Italy)
Tel. +39 02 3535955 r.a. Fax. +39 02 3539929
E. Mail: info@omar-alluminio.it

Cataloghi Online: www.omar-alluminio.it
www.omar-alluminio.com
PROFILATI ALLUMINIO A DISEGNO / STANDARD / SPECIALI / E PER:
ELETTRONICA / LED / FOTOVOLTAICO / AUTOMAZIONE ROBOTICA / PNEUMATICA / AUTOMOTIVE

473

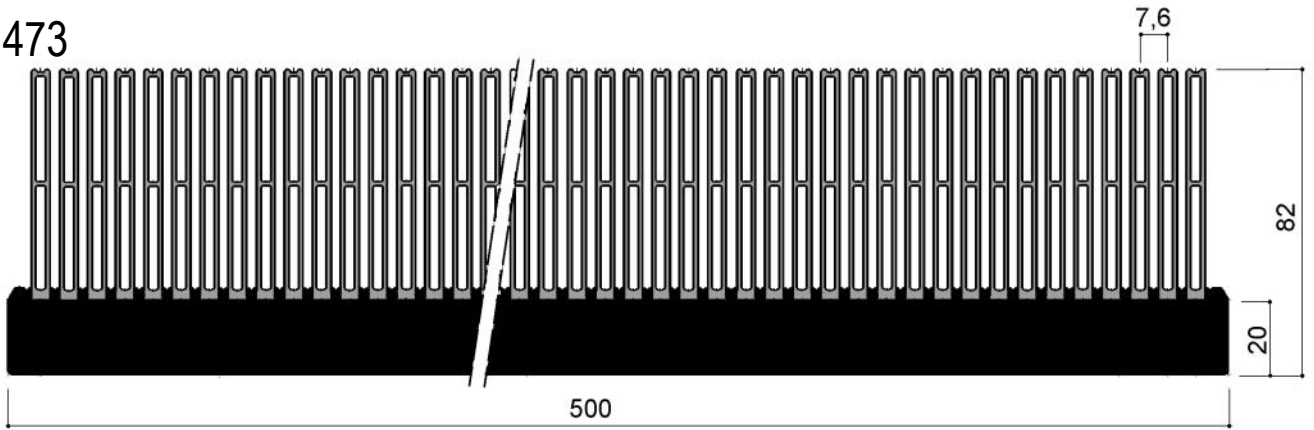

Resistenza termica (K/W) in ventilazione forzata

Lg. (mm)	200	300	400	500
R _{th} a 5m/s	0,0 129	0,0 102	0,0 087	0,0077

length 11.81 in. [300mm]

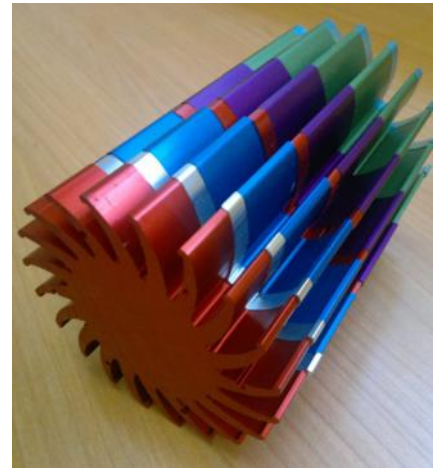
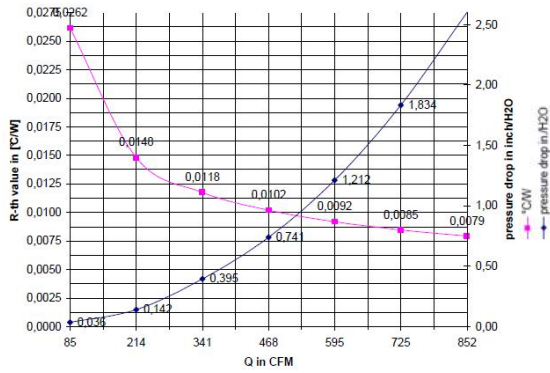

461

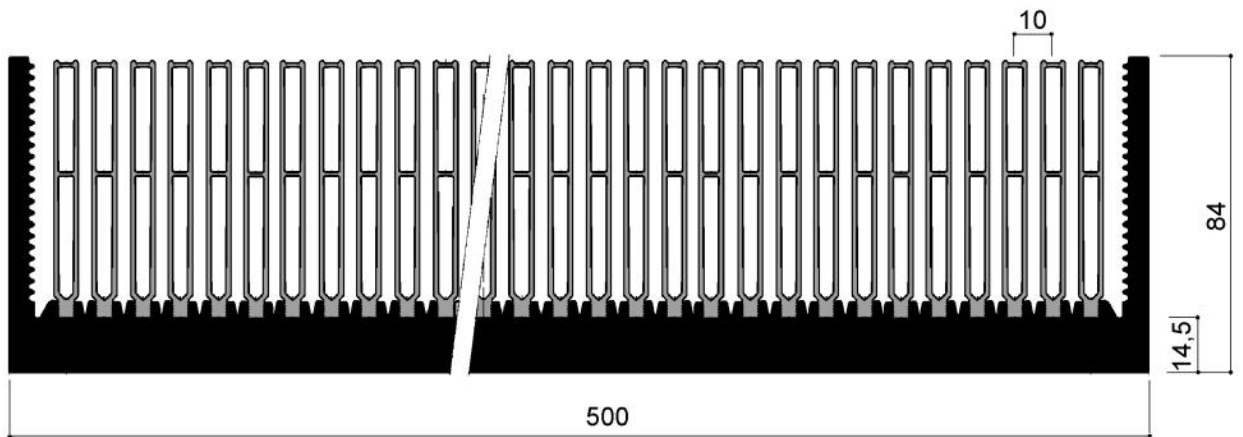

Resistenza termica (K/W) in ventilazione forzata

Lg. (mm)	100	200	300	400	500
R _{th} a 5m/s	0,0324	0,0215	0,0171	0,0147	0,0131

length 15.74 in. [400mm]

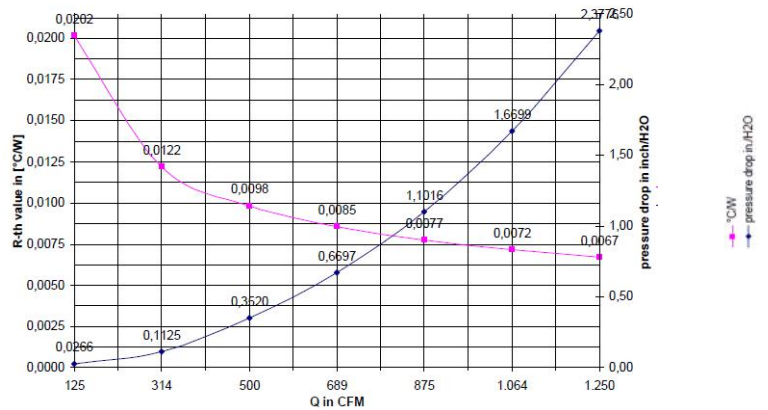

DISSIPATORI AD ALTO RENDIMENTO



DISEGNI META' DEL VERO (1:2)- SCALE 1:2

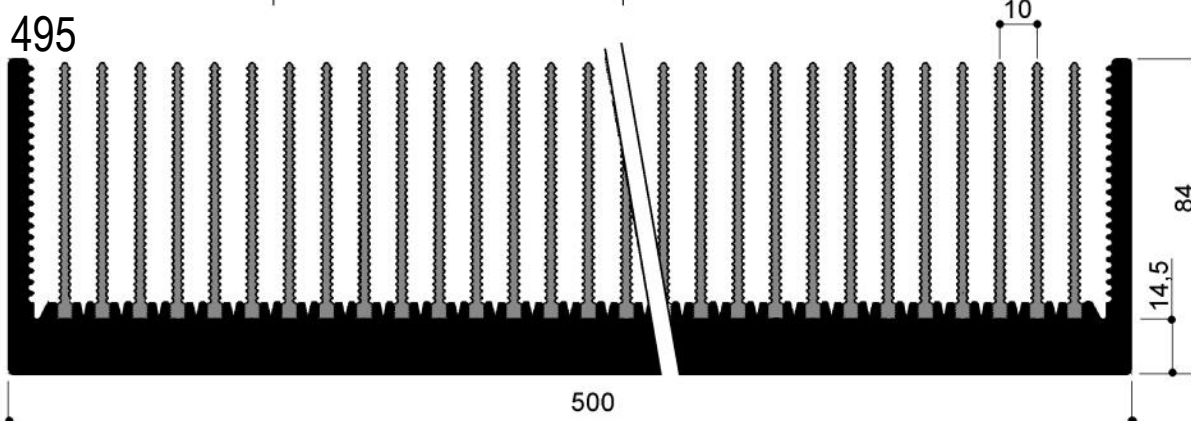

Resistenza termica (K/W) in ventilazione forzata

Lg. (mm)	100	200	300	400	500
R _h 5 m/s	0,0473	0,0817	0,0270	0,0215	0,0178

length 19.68 in. [500mm]

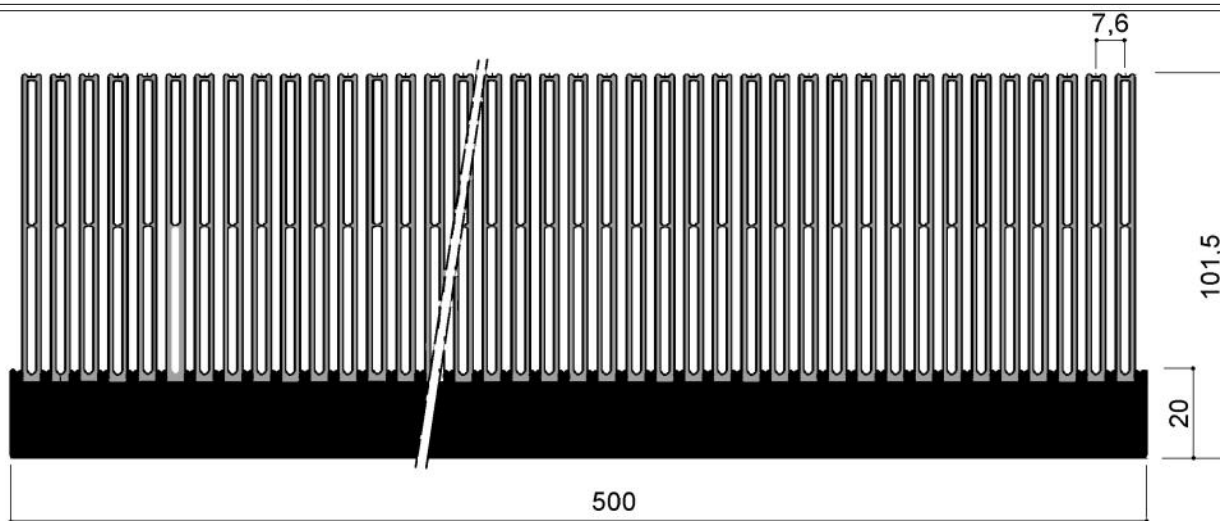
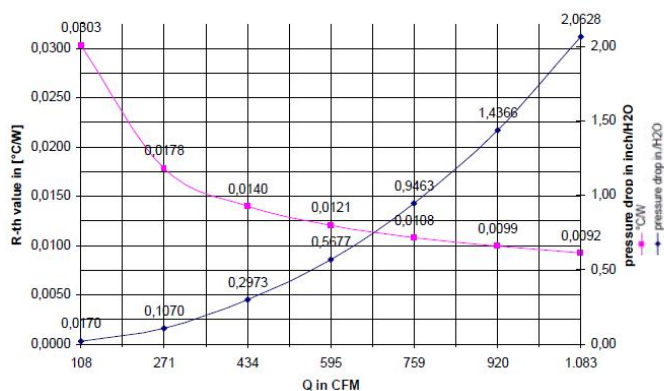

478

length 11.81 in. [300mm]

Resistenza termica (K/W) in ventilazione forzata

Lg. (mm)	200	300	400	500
R _h a 11 m/s	0,0109	0,0085	0,0072	0,0063

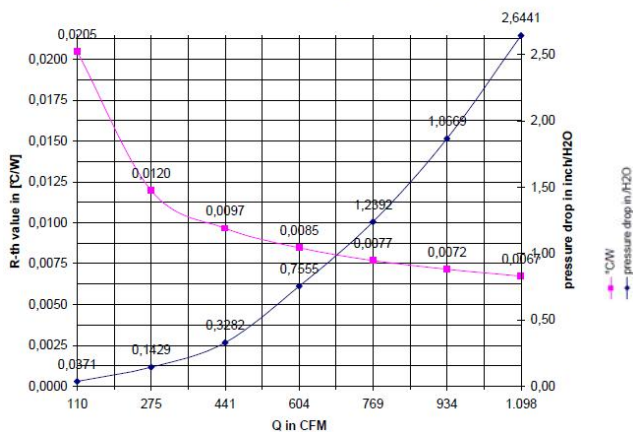

Via Newton, n.12
20016 Pero (Milano - Italy)
Tel. +39 02 3535955 r.a. Fax. +39 02 3539929
E-Mail: info@omar-alluminio.it

Cataloghi Online: www.omar-alluminio.it
www.omar-alluminio.com

PROFILATI ALLUMINIO A DISEGNO / STANDARD / SPECIALI / E PER:
ELETTRONICA / LED / FOTOVOLTAICO / AUTOMAZIONE ROBOTICA / PNEUMATICA / AUTOMOTIVE



DISSIPATORI AD ALTO RENDIMENTO

DISEGNI META' DEL VERO (1:2)- SCALE 1:2

Via Newton, n.12
20016 Pero (Milano - Italy)
Tel. +39 02 3535955 r.a. Fax. +39 02 3539929
E. Mail: info@omar-alluminio.it

Cataloghi Online: www.omar-alluminio.it
www.omar-alluminio.com

PROFILATI ALLUMINIO A DISEGNO / STANDARD / SPECIALI / E PER:
ELETTRONICA / LED / FOTOVOLTAICO / AUTOMAZIONE ROBOTICA / PNEUMATICA / AUTOMOTIVE

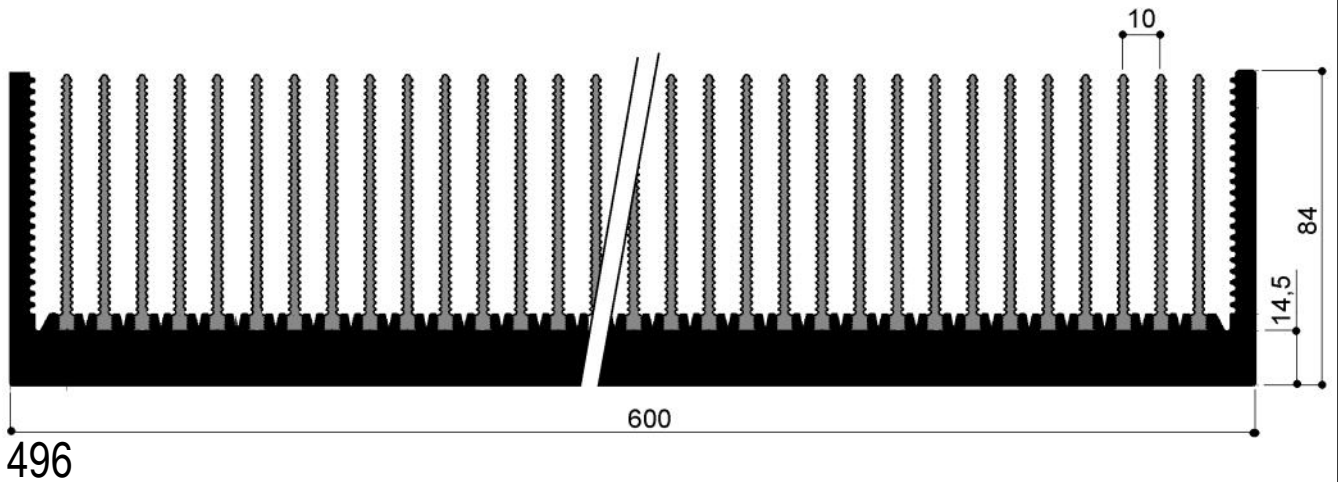
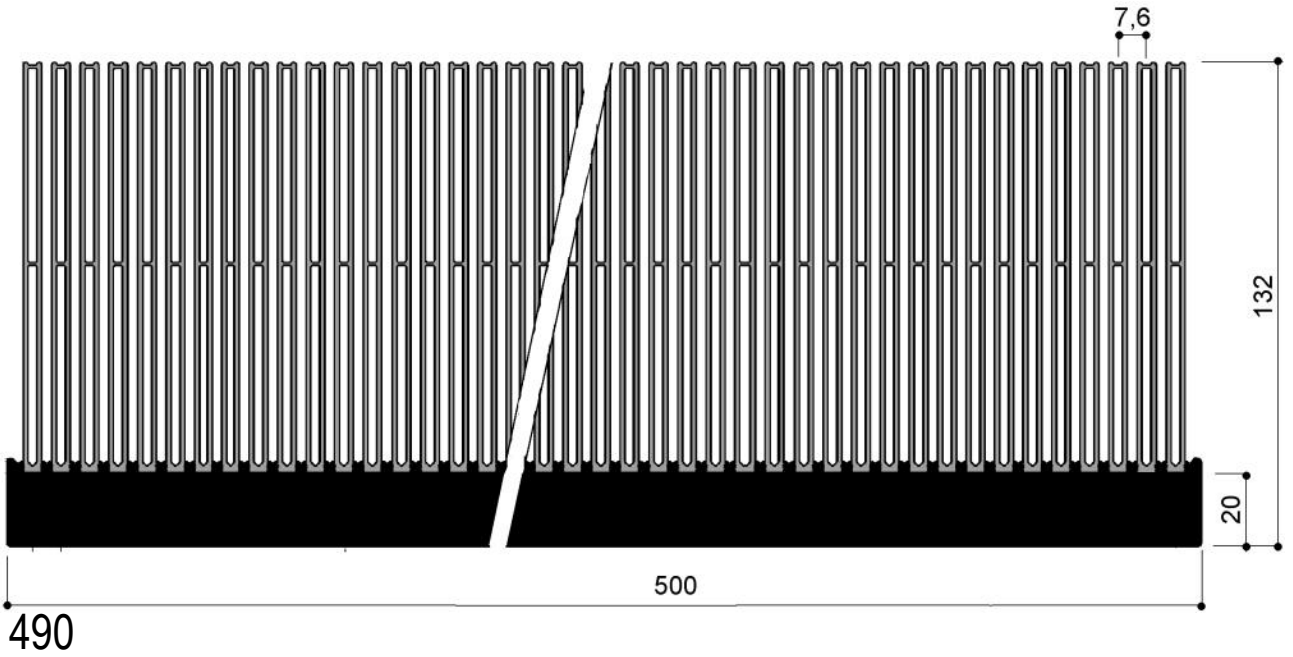

Resistenza termica (K/W) in ventilazione forzata

lg. (mm)	100	200	300	400	500	600
Rh5 m/s	0,034	0,0263	0,0211	0,0182	0,0152	0,0134

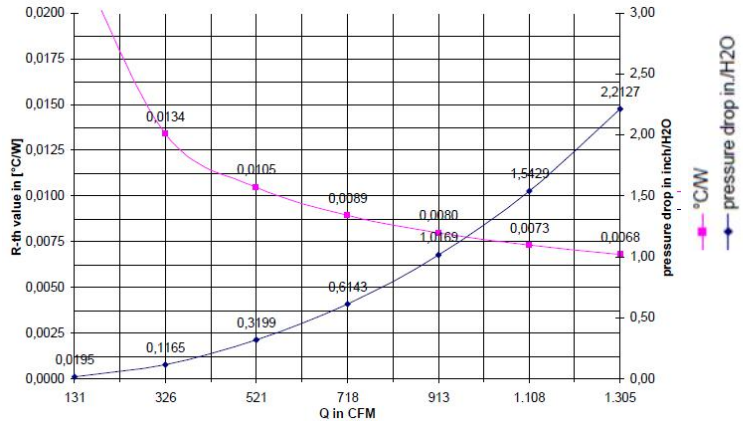

DISSIPATORI AD ALTO RENDIMENTO

DISEGNI META' DEL VERO (1:2)- SCALE 1:2

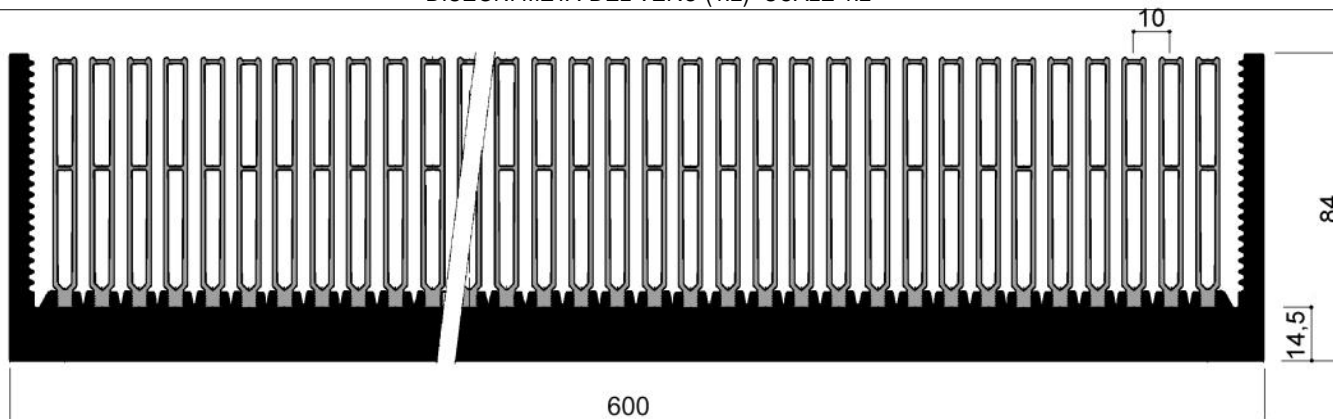

468

length 15.74 in. [400mm]

Resistenza termica (K/W) in ventilazione forzata

Lg. (mm)	100	200	300	400	500	600
R _{th} a 11 m/s	0,0269	0,0178	0,0142	0,0122	0,0109	0,0100

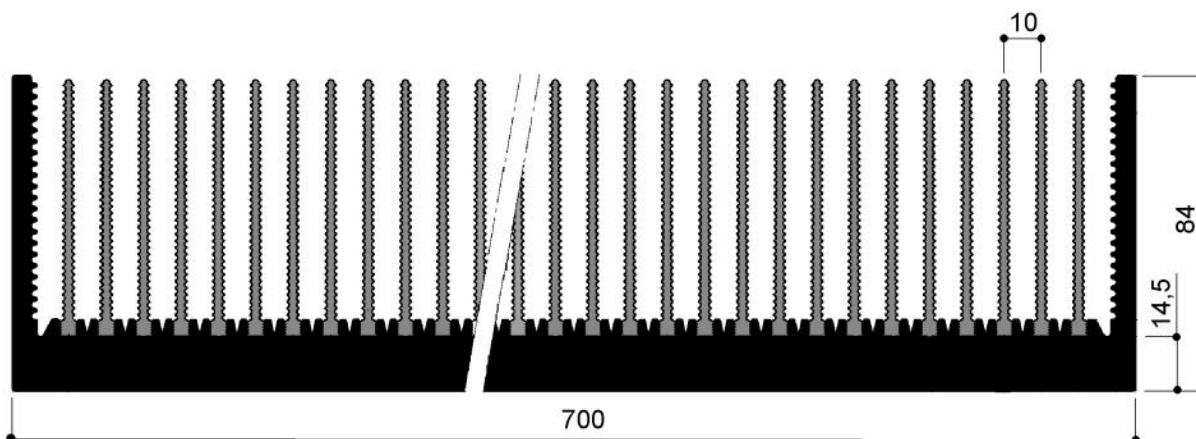
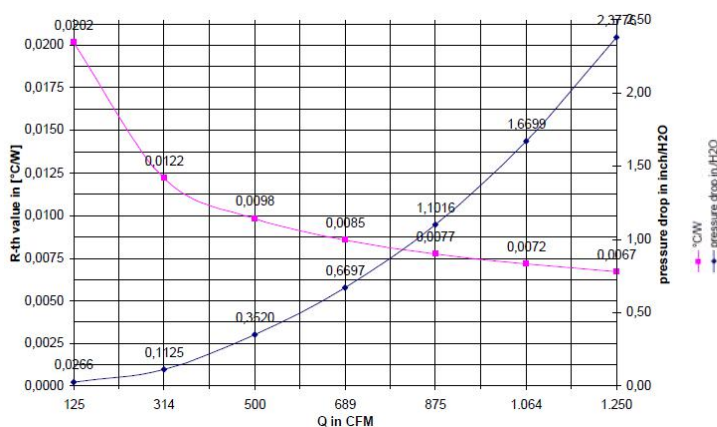

497

length 27.55 in. [700mm]

Resistenza termica (K/W) in ventilazione forzata

Lg. (mm)	200	300	400	500	600	700
R _{th}	0,0210	0,0168	0,0143	0,0121	0,0107	0,0099

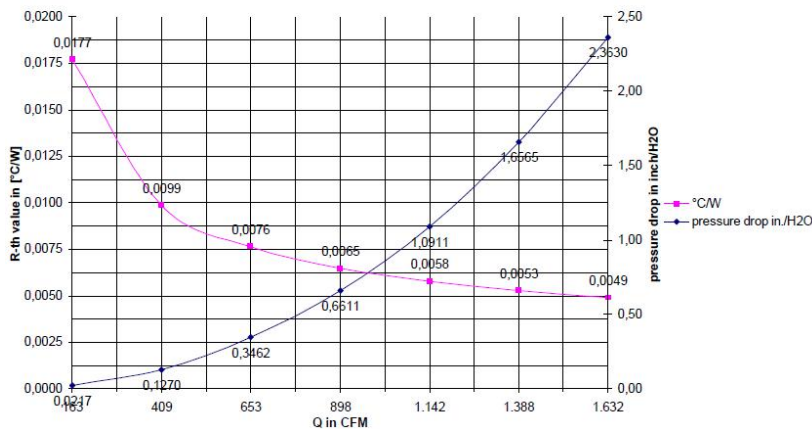

Via Newton, n.12
20016 Pero (Milano - Italy)
Tel. +39 02 3535955 r.a. Fax. +39 02 3539929
E-Mail: info@omar-alluminio.it

Cataloghi Online: www.omar-alluminio.it

www.omar-alluminio.com

PROFILATI ALLUMINIO A DISEGNO / STANDARD / SPECIALI / E PER:

ELETTRONICA / LED / FOTOVOLTAICO / AUTOMAZIONE ROBOTICA / PNEUMATICA / AUTOMOTIVE



DISSIPATORI AD ALTO RENDIMENTO



Via Newton, n.12
20016 Pero (Milano - Italy)
Tel. +39 02 3535955 r.a. Fax. +39 02 3539929
E-Mail: info@omar-alluminio.it

Cataloghi Online: www.omar-alluminio.it
www.omar-alluminio.com
PROFILATI ALLUMINIO A DISEGNO / STANDARD / SPECIALI / E PER:
ELETTRONICA / LED / FOTOVOLTAICO / AUTOMAZIONE ROBOTICA / PNEUMATICA / AUTOMOTIVE

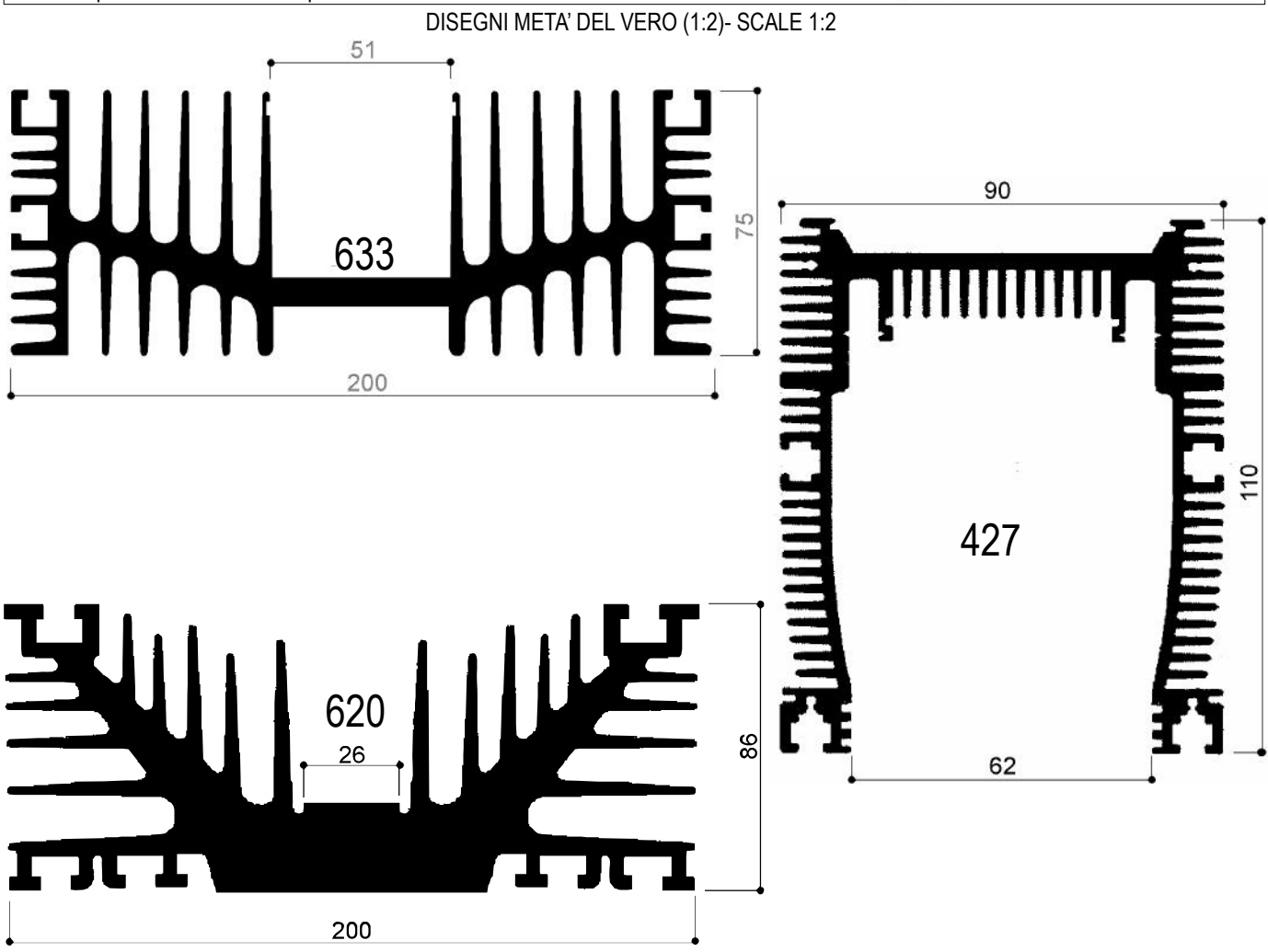
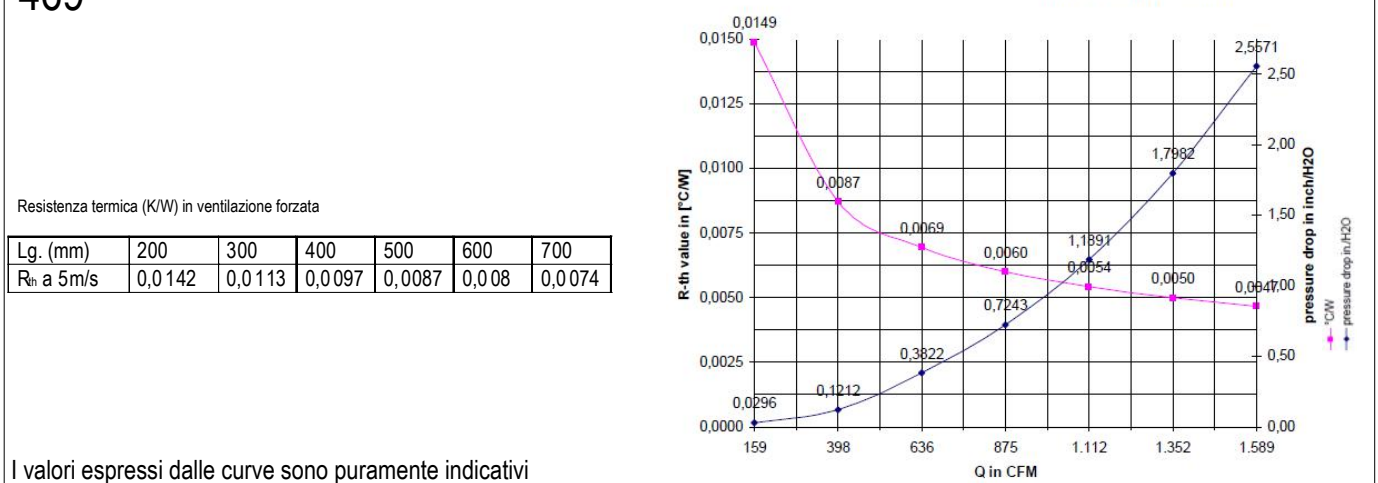
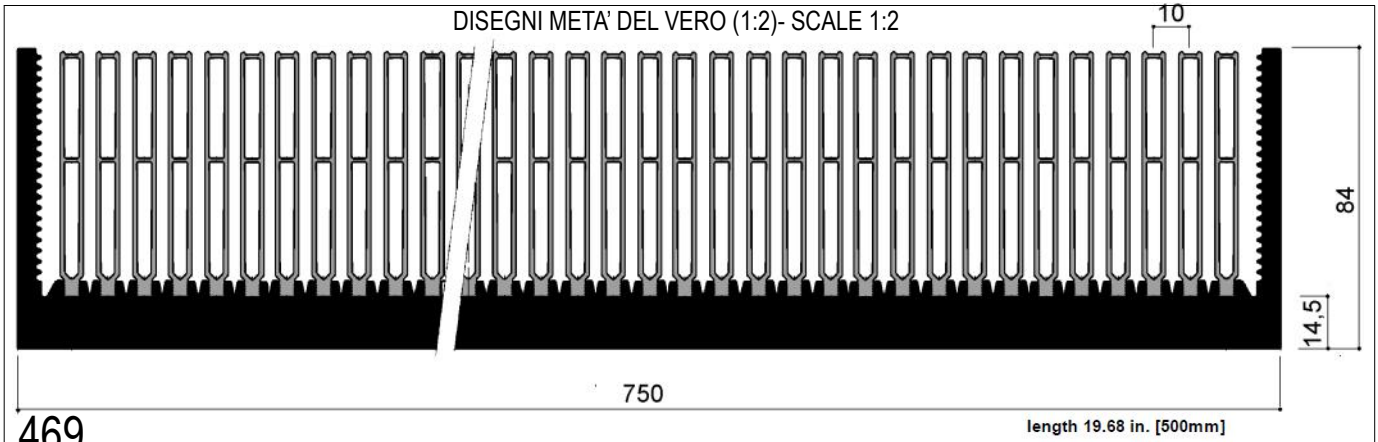

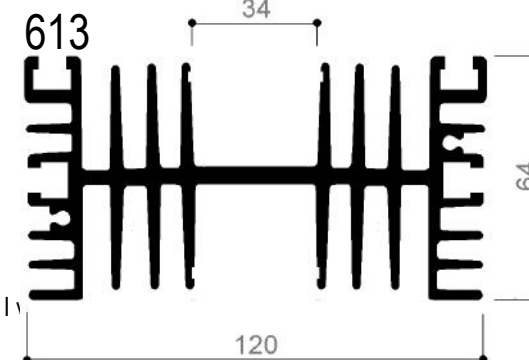
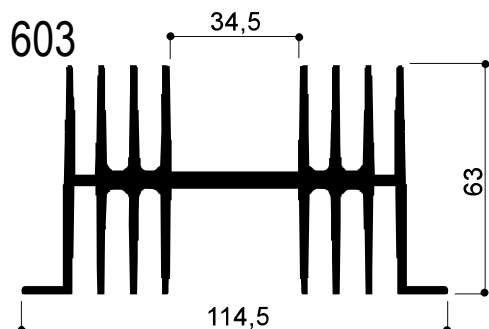
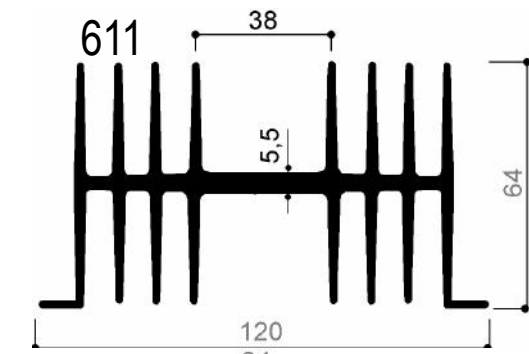
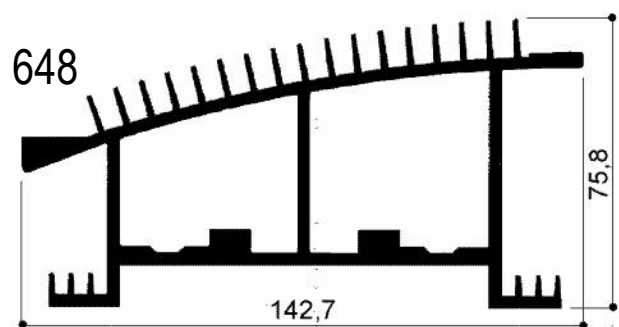
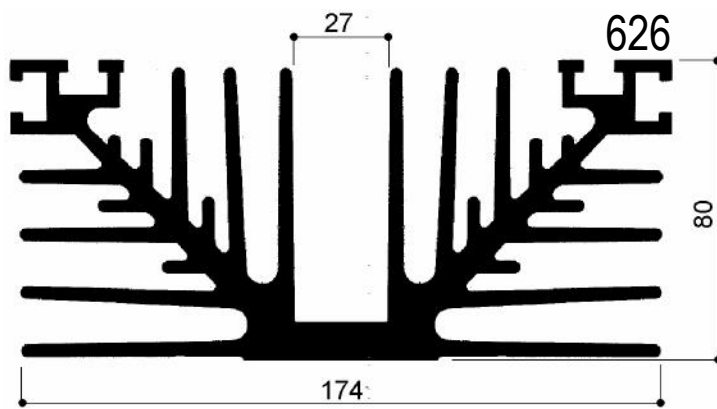
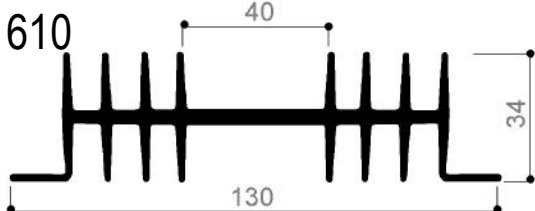
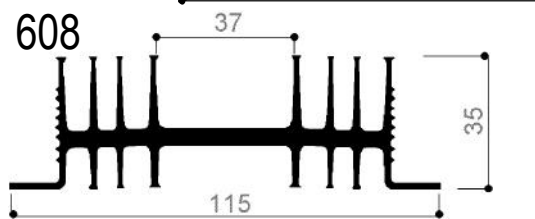
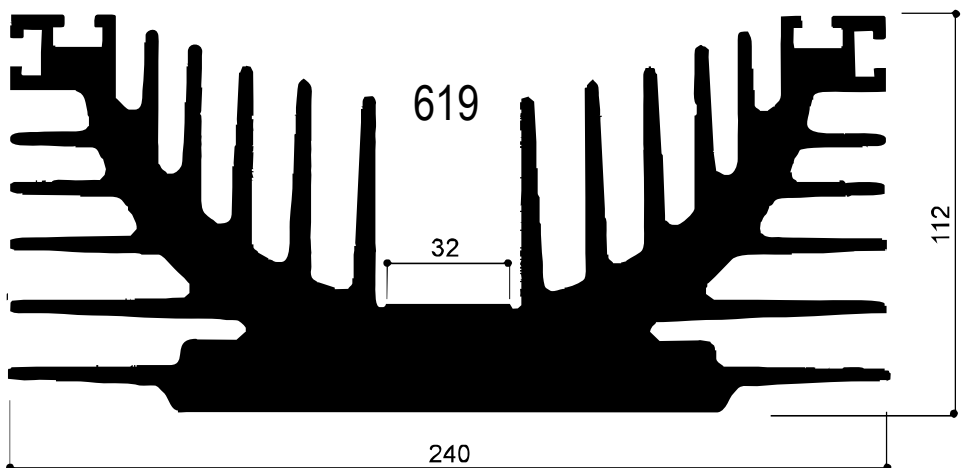
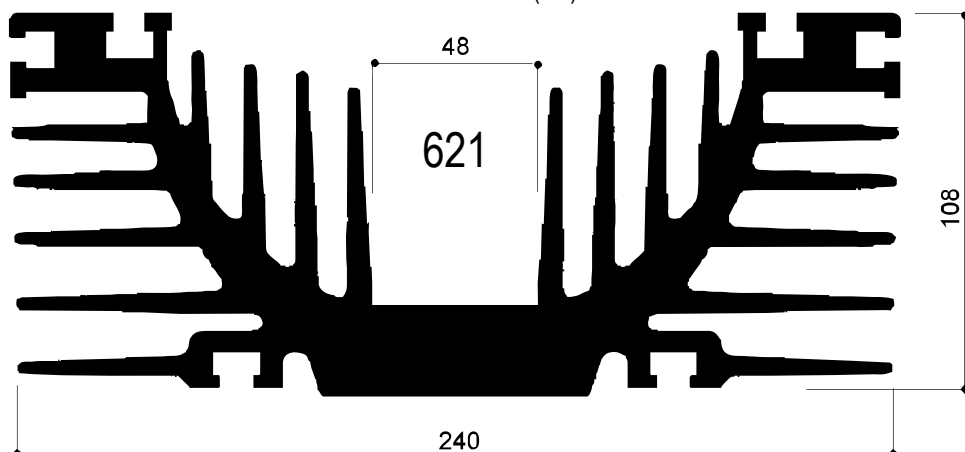

Via Newton, n.12
20016 Pero (Milano - Italy)
Tel. +39 02 3535955 r.a. Fax. +39 02 3539929
E-Mail: info@omar-alluminio.it

Cataloghi Online: www.omar-alluminio.it
www.omar-alluminio.com

PROFILATI ALLUMINIO A DISEGNO / STANDARD / SPECIALI / E PER:
ELETTRONICA / LED / FOTOVOLTAICO / AUTOMAZIONE ROBOTICA / PNEUMATICA / AUTOMOTIVE

AGGIORNAMENTO CONTINUO - ED. DEL 03-2023





DISEGNI META' DEL VERO (1:2)- SCALE 1:2

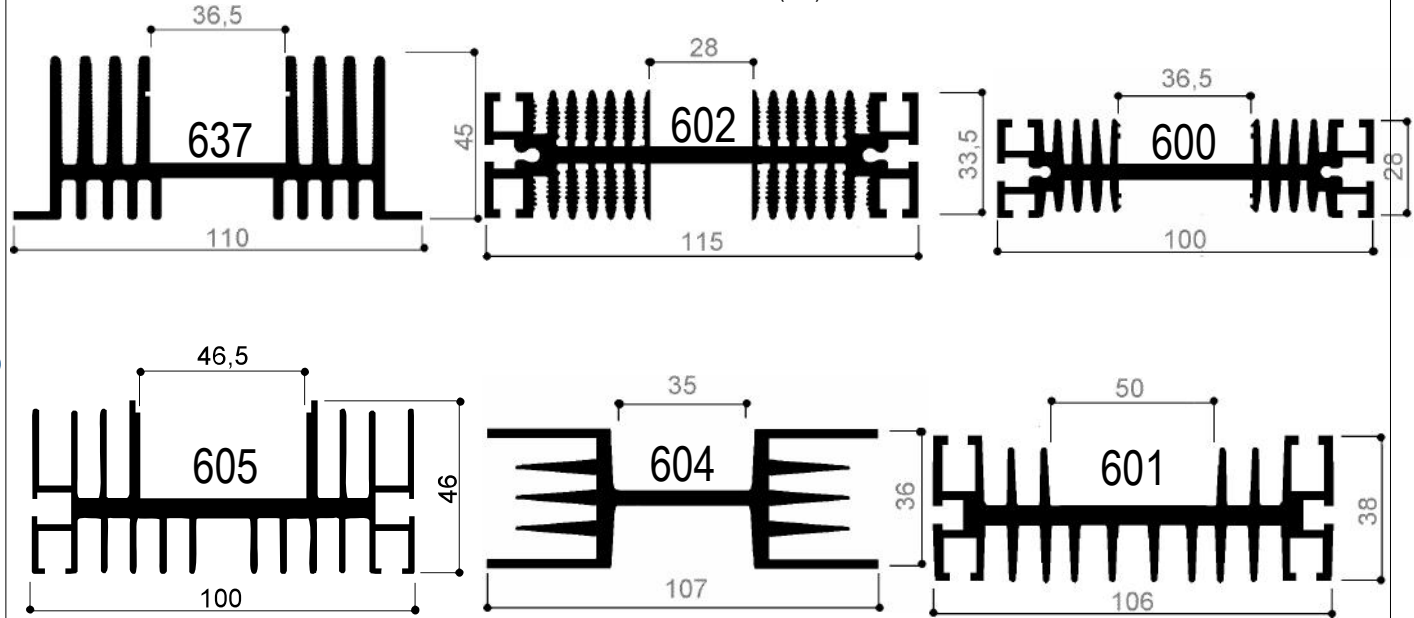

SISTEMI DI RADIAZIONE
 A VENTILAZIONE FORZATA
 COOLING AGGREGATES



DISEGNI META' DEL VERO (1:2)- SCALE 1:2

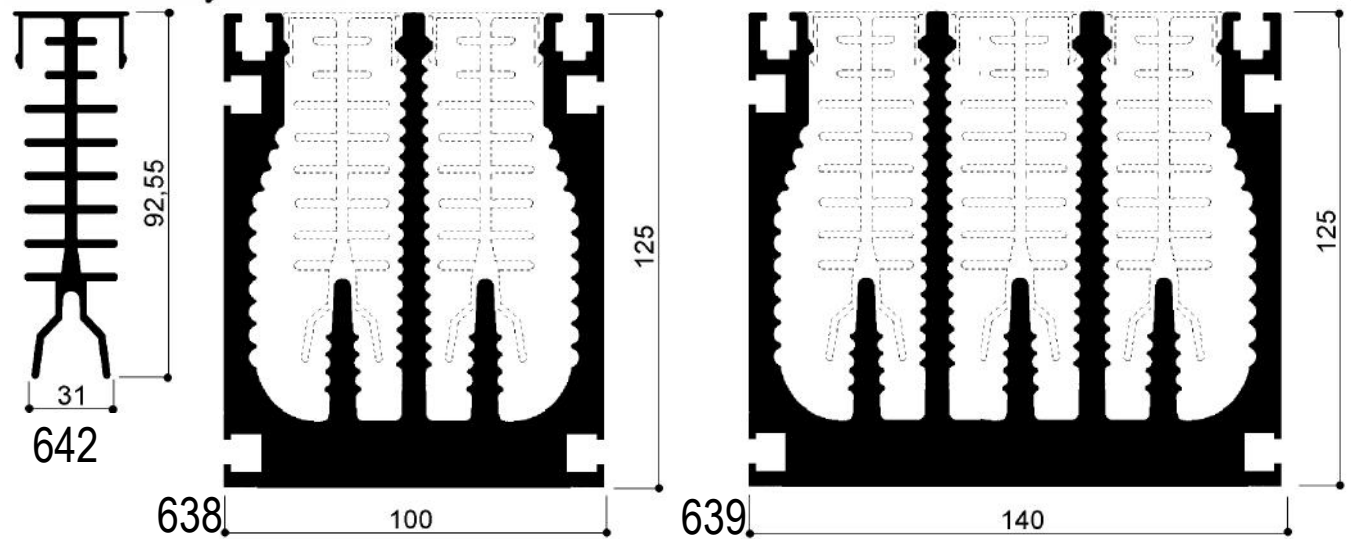
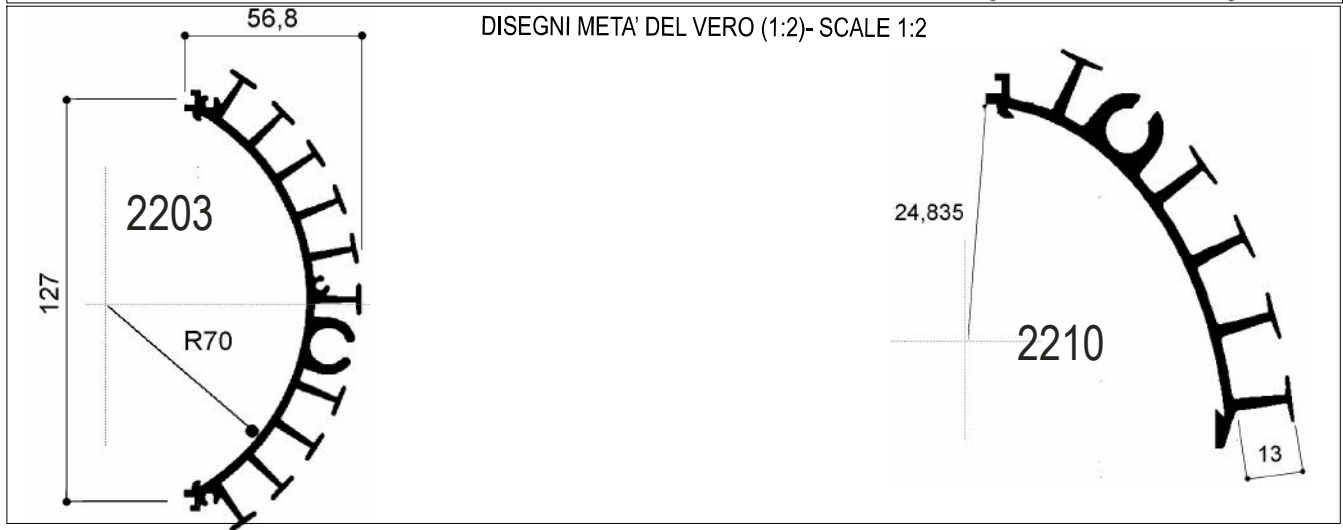

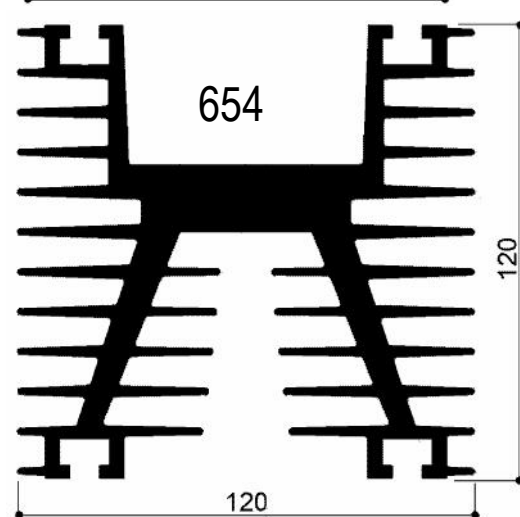
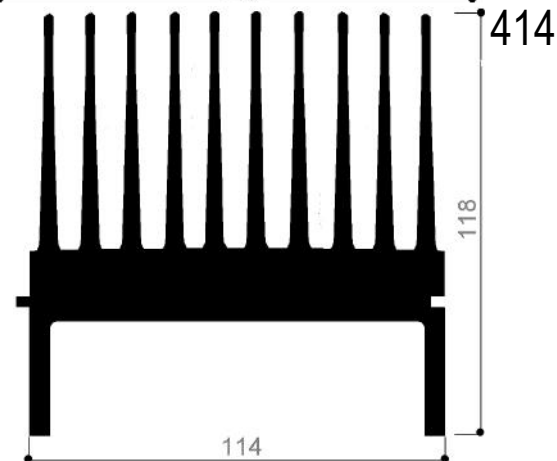
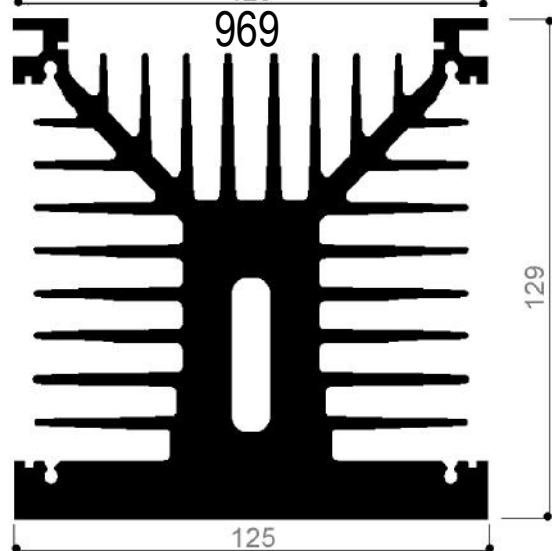
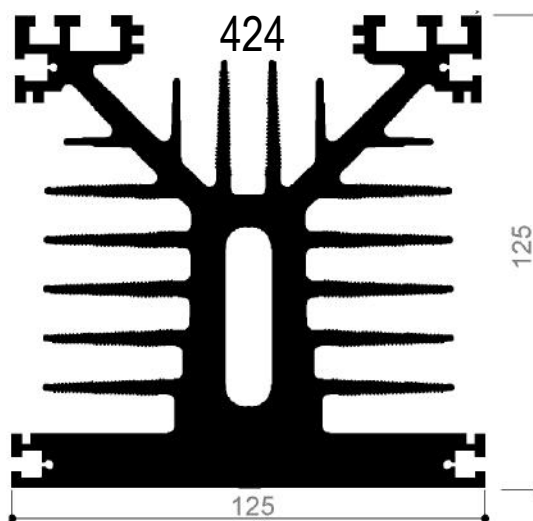
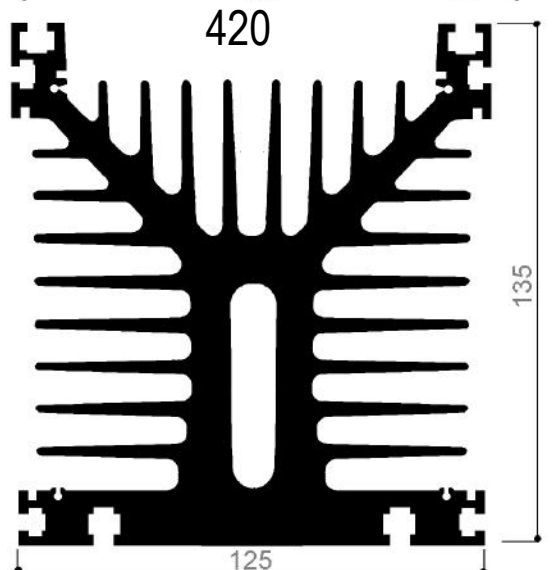
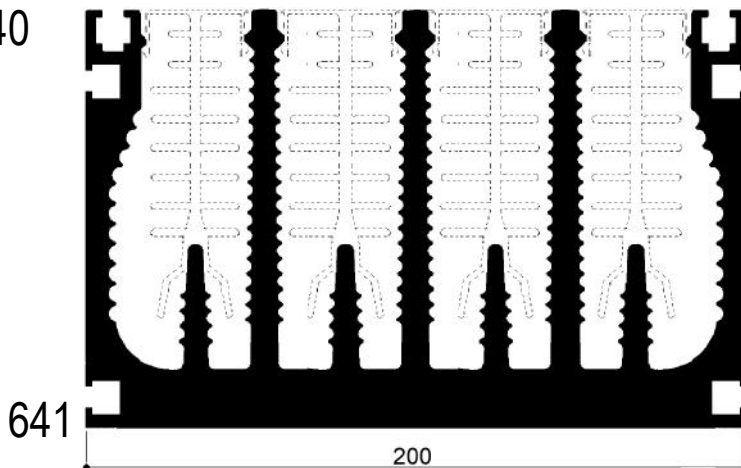
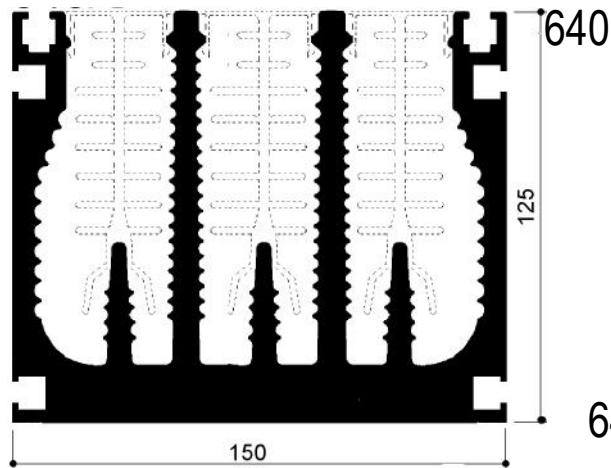

Via Newton, n.12
20016 Pero (Milano - Italy)
Tel. +39 02 3535955 r.a. Fax. +39 02 3539929
E-Mail: info@omar-alluminio.it

Cataloghi Online: www.omar-alluminio.it
www.omar-alluminio.com

PROFILATI ALLUMINIO A DISEGNO / STANDARD / SPECIALI / E PER:
ELETTRONICA / LED / FOTOVOLTAICO / AUTOMAZIONE ROBOTICA / PNEUMATICA / AUTOMOTIVE



Dissipatori di calore in alluminio per illuminazione a Led



Cataloghi Online: www.omar-alluminio.it

www.omar-alluminio.com

PROFILATI ALLUMINIO A DISEGNO / STANDARD / SPECIALI / E PER:

ELETTRONICA / LED / FOTOVOLTAICO / AUTOMAZIONE ROBOTICA / PNEUMATICA / AUTOMOTIVE

Via Newton, n.12

20016 Pero (Milano - Italy)

Tel. +39 02 3535955 r.a. Fax. +39 02 3539929

E-Mail: info@omar-alluminio.it

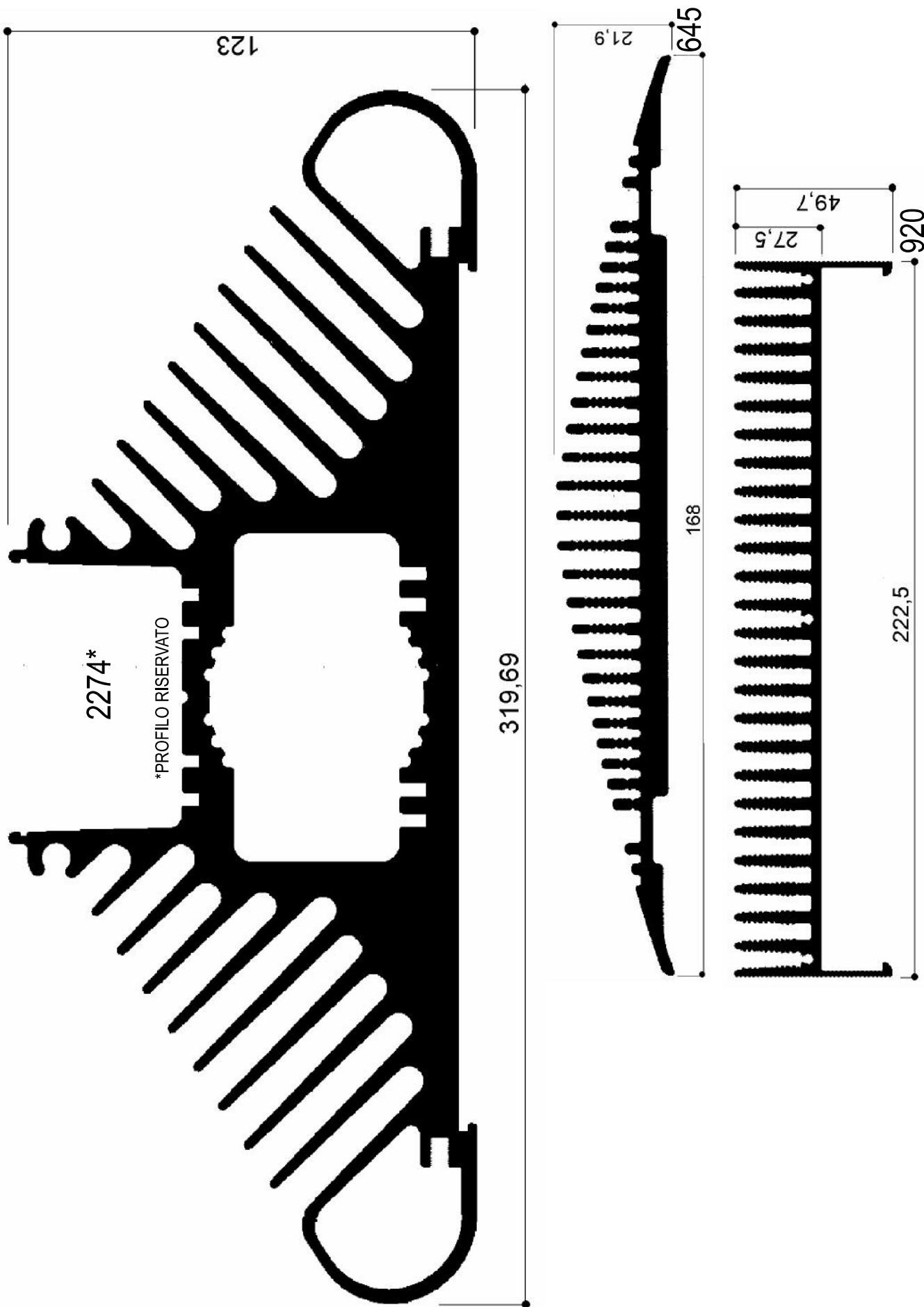

Dissipatori di calore in alluminio per illuminazione a Led

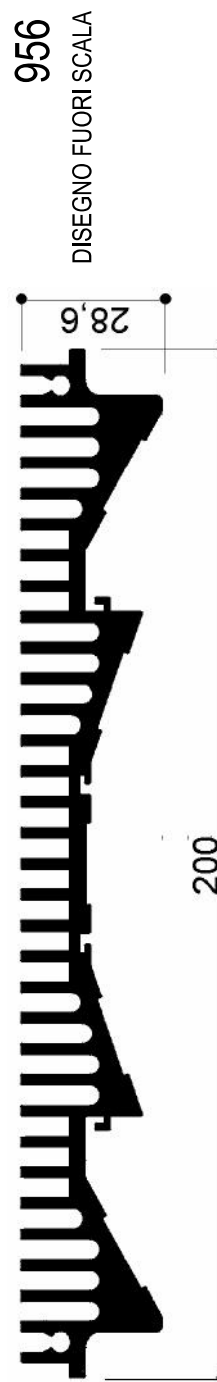
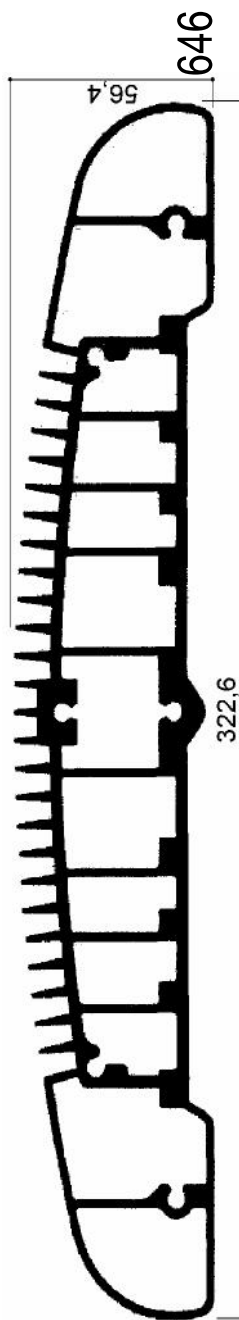
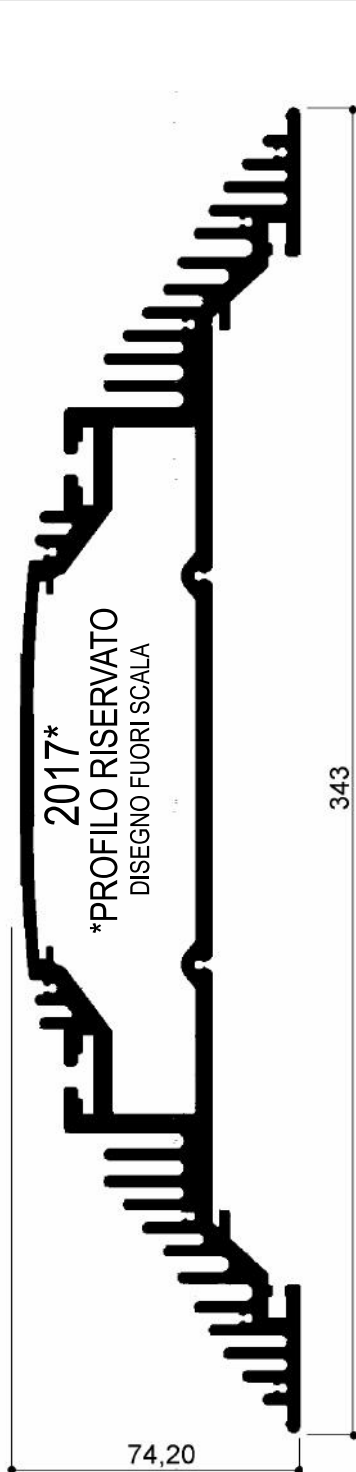
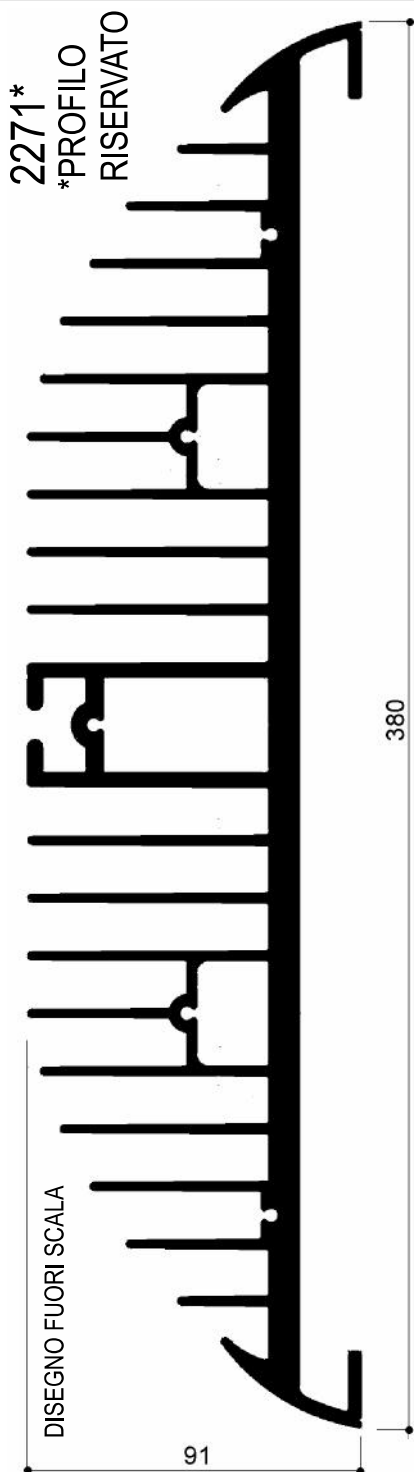

Cataloghi Online: www.omar-alluminio.it
www.omar-alluminio.com

PROFILATI ALLUMINIO A DISEGNO / STANDARD / SPECIALI / E PER:
ELETTRONICA / LED / FOTOVOLTAICO / AUTOMAZIONE ROBOTICA / PNEUMATICA / AUTOMOTIVE

Via Newton, n.12
20016 Pero (Milano - Italy)
Tel. +39 02 3535955 r.a. Fax. +39 02 3539929
E-Mail: info@omar-alluminio.it

Dissipatori di calore in alluminio per illuminazione a Led



DISEGNO FUORI SCALA

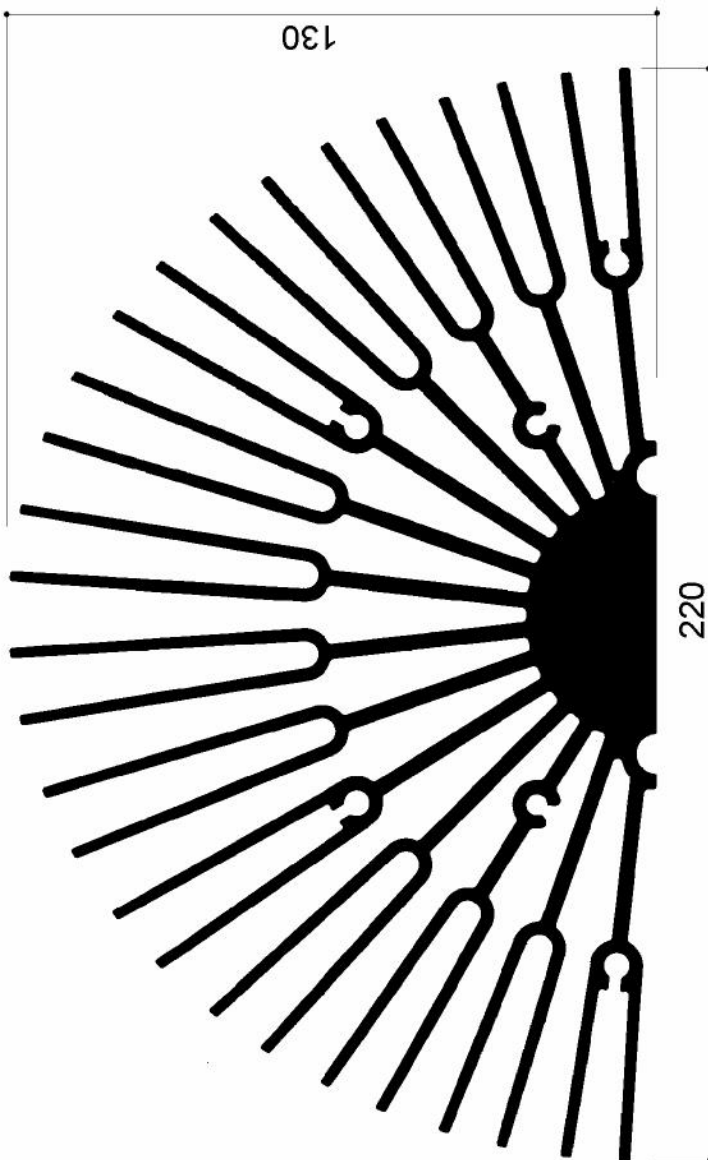
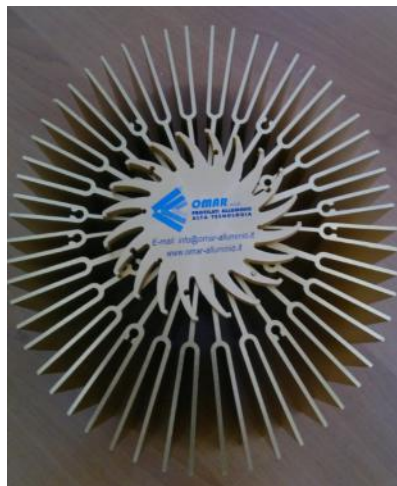

2098* PROFILO RISERVATO



Cataloghi Online: www.omar-alluminio.it
www.omar-alluminio.com

PROFILATI ALLUMINIO A DISEGNO / STANDARD / SPECIALI / E PER:
ELETTRONICA / LED / FOTOVOLTAICO / AUTOMAZIONE ROBOTICA / PNEUMATICA / AUTOMOTIVE

Via Newton, n.12

20016 Pero (Milano - Italy)

Tel. +39 02 3535955 r.a. Fax. +39 02 3539929

E. Mail: info@omar-alluminio.it

OMAR s.r.l.
PROFILATI ALLUMINIO
ALTA TECNOLOGIA

Dissipatori di calore in alluminio per illuminazione a Led



DISEGNI AL VERO SCALA 1:1

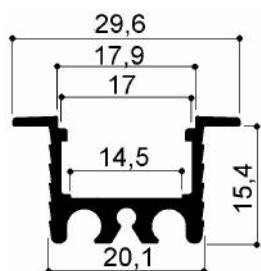

526

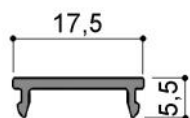

COV526

ESEMPIO PROFILI ASSEMBLATI

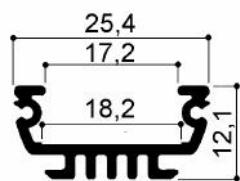

527

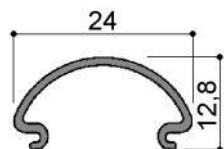

COV527

ESEMPIO PROFILI ASSEMBLATI

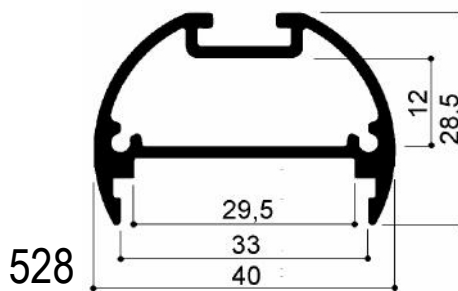
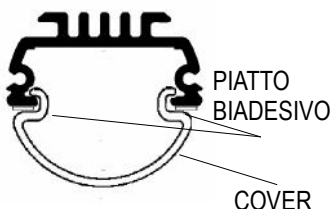

528



COV528

ESEMPIO PROFILI ASSEMBLATI

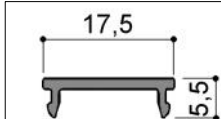
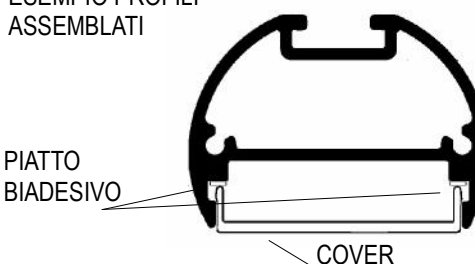

COV526 cover in policarbonato autoestinguente

- COV526-PT: cover trasparente
- COV526-PO: cover opale
- COV526-PST: cover satinato trasparente
- COV526-PSO: cover satinato opale

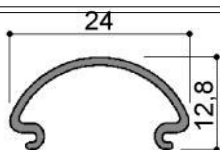

COV527 cover in policarbonato autoestinguente

- COV527-PT: cover trasparente
- COV527-PO: cover opale
- COV527-PST: cover satinato trasparente
- COV527-PSO: cover satinato opale



COV528 cover in policarbonato autoestinguente

- COV528-PT: cover trasparente
- COV528-PO: cover opale
- COV528-PST: cover satinato trasparente
- COV528-PSO: cover satinato opale
- COV528-PTMIC: trasparente microprismato



COV533 cover in policarbonato autoestinguente

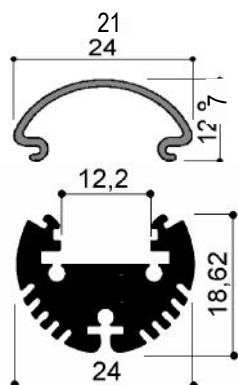

533



TAPPO CON FORO PASSACAVO IN ALLUMINIO ANODIZZATO PER ART.533 COD.ART.:L-0016

TAPPO CON FORO PASSACAVO IN ALLUMINIO ANODIZZATO PER ART.533 COD.ART.:L-0015

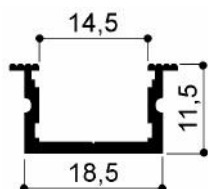

534

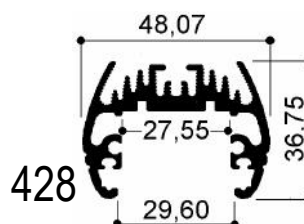

428

Via Newton, n.12

20016 Pero (Milano - Italy)

Tel. +39 02 3535955 r.a. Fax. +39 02 3539929

E-Mail: info@omar-alluminio.it

Cataloghi Online: www.omar-alluminio.it

www.omar-alluminio.com

PROFILATI ALLUMINIO A DISEGNO / STANDARD / SPECIALI / E PER:

ELETTRONICA / LED / FOTOVOLTAICO / AUTOMAZIONE ROBOTICA / PNEUMATICA / AUTOMOTIVE



Profili in alluminio per STRISCE A LED



TAPPO CHIUSO IN ABS COLORE ARGENTO PER ART.526 COD.ART.: L-0001



TAPPO CON FORO PASSACAVO IN ABS COLORE ARGENTO PER ART.526 COD.ART.:L-0002



MOLLA PER FISSAGGIO A CARTONGESSO PER ART. FM526 COD.ART.: L-0017



TAPPO CHIUSO IN ABS COLORE ARGENTO PER ART.527 COD.ART.: L-0006



TAPPO CON FORO PASSACAVO IN ABS COLORE ARGENTO PER ART.527 COD.ART.: L-0007



STAFFA DI FISSAGGIO IN ABS COLORE ARGENTO ART.527 COD.ART.: L-0008



STAFFA DI FISSAGGIO ROTANTE REGOLABILE IN ABS COLORE ARGENTO ART.527 COD.ART.: L-0014



TAPPO CHIUSO IN ABS COLORE ARGENTO PER ART.528 COD.ART.:L-0010



TAPPO CON FORO PASSACAVO IN ABS COLORE ARGENTO PER ART.528 COD.ART.: L-0011



KIT STAFFA PER FISSAGGIO A PARETE/SOSPENSIONE COLORE NERO PER ART.528 COD.ART.: L-0013



PASSA CAVO COD.ART.: L-0012



VITI AUTOFILETTANTI 2,9X9,5 PER FISSAGGIO TAPPO AL PROFILO FM526 E FM528 CONFEZIONI DA 100PZ COD.ART.: L-0005 - VITI AUTOFILETTANTI 2x6 PER FISSAGGIO TAPPO AL PROFILO FM527 CONFEZIONI DA 100PZ COD.ART.: L-0009



TAPPO CHIUSO IN ALLUMINIO ANODIZZATO ARGENTO PER ART.533 COD.ART.:L-0015



TAPPO CON FORO PASSACAVO IN ALLUMINIO ANODIZZATO ARGENTO PER ART.528 COD.ART.: L-0016

Via Valerbona, 1212
20090 Pieve (Milano) Italy
Tel: +39 032 3539595 Fax: +39 032 3539929
E: mail@omaralluminio.it

Cataloghi Online: www.omar-alluminio.it
www.omar-alluminio.com

PROFILATI ALLUMINIO A DISEGNO / STANDARD / SPECIALI / E PER:
ELETTRONICA / LED / FOTOVOLTAICO / AUTOMAZIONE ROBOTICA / PNEUMATICA / AUTOMOTIVE

OMAR s.r.l.
PROFILATI ALLUMINIO
ALTA TECNOLOGIA

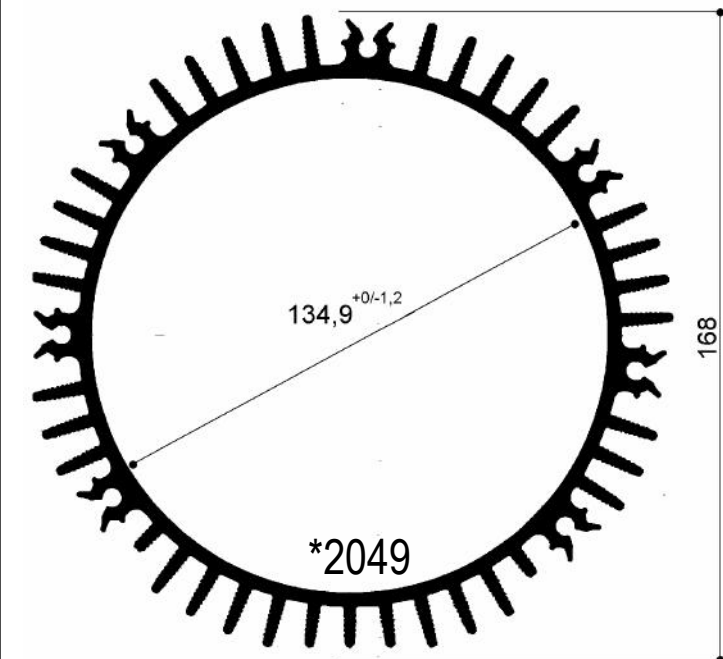
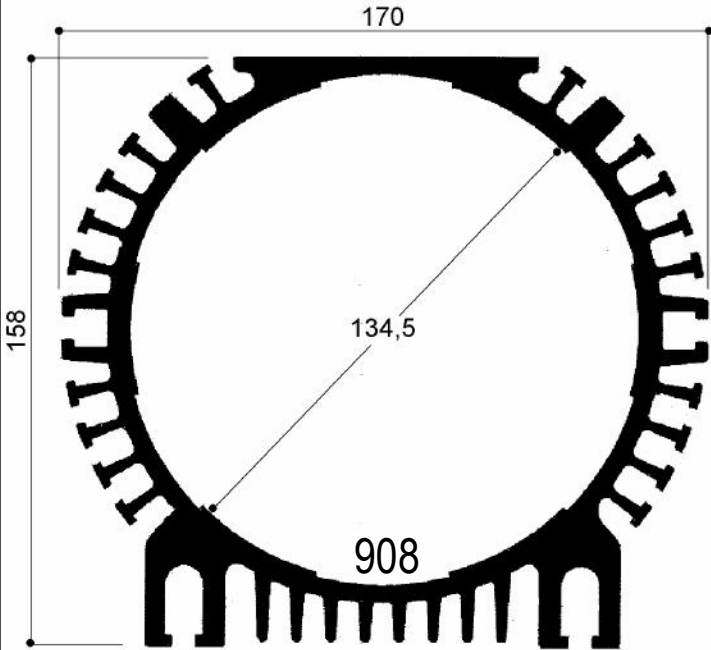
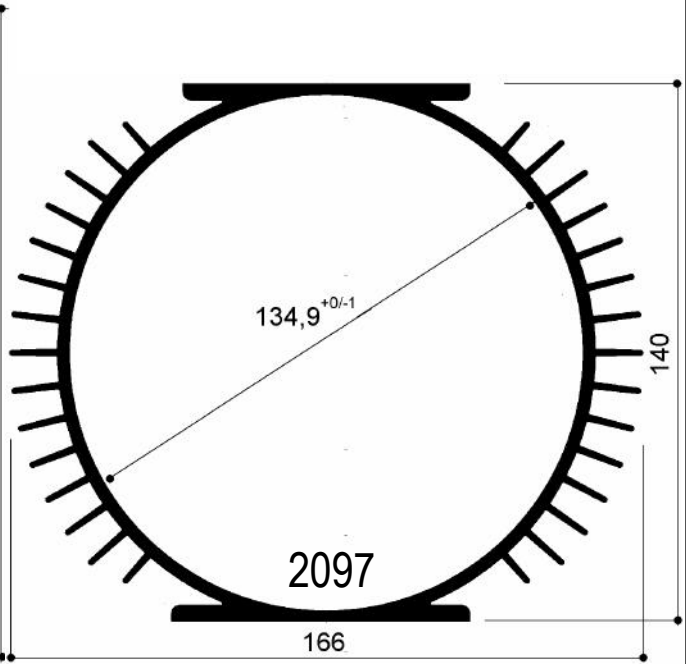
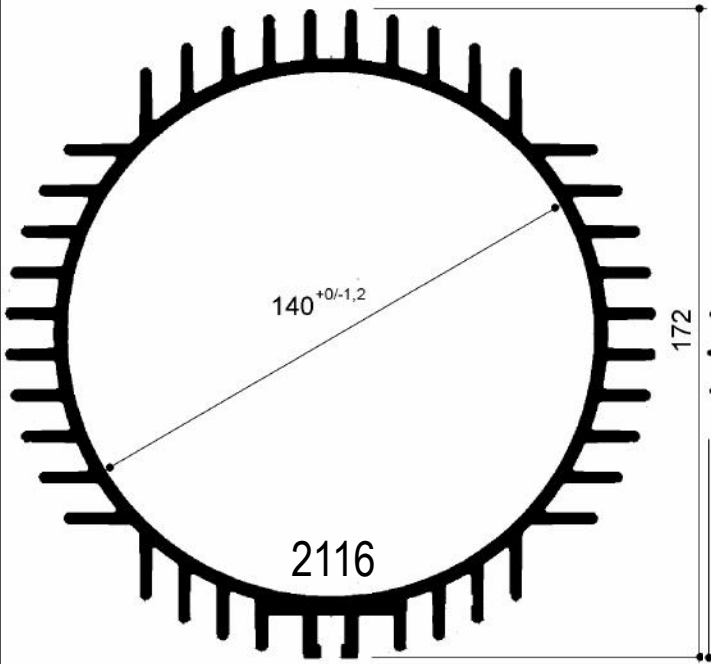

Cataloghi Online: www.omar-alluminio.it

www.omar-alluminio.com

PROFILATI ALLUMINIO A DISEGNO / STANDARD / SPECIALI / E PER:
ELETTRONICA / LED / FOTVOLTAICO / AUTOMAZIONE ROBOTICA / PNEUMATICA / AUTOMOTIVE

Via Newton, n.12

20016 Pero (Milano - Italy)

Tel. +39 02 35359555 r.a. Fax. +39 02 3539929

E-Mail: info@omar-alluminio.it



DISEGNI META' DEL VERO (1:2)- SCALE 1:2

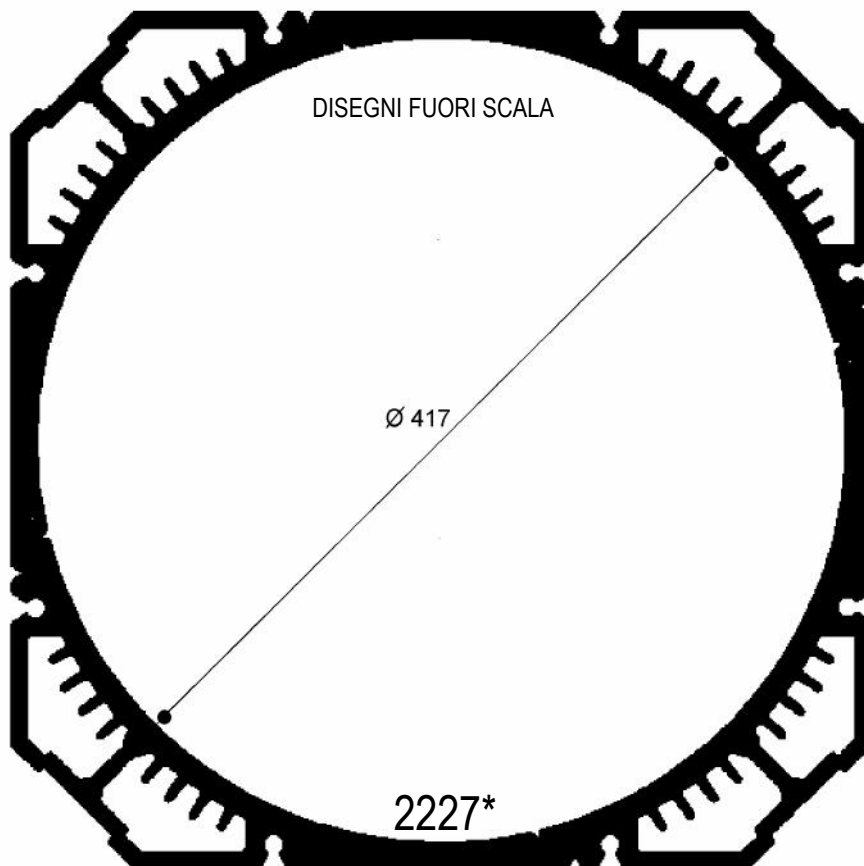
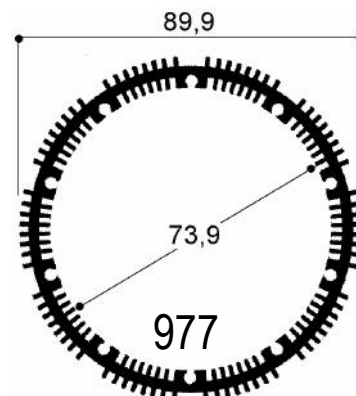
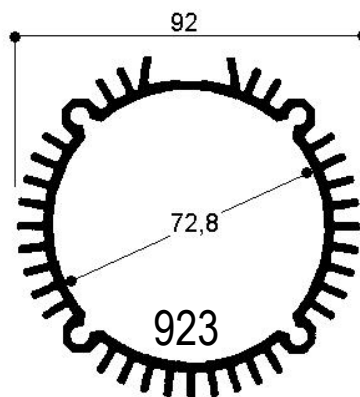
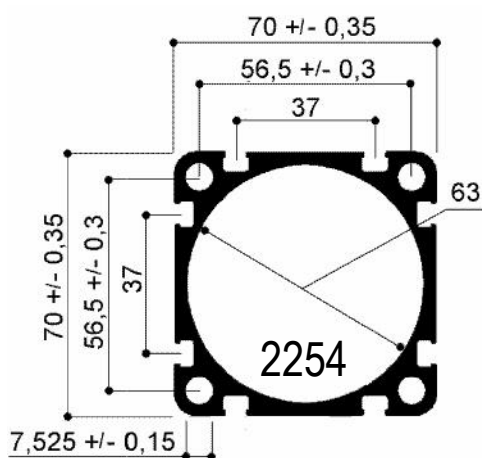
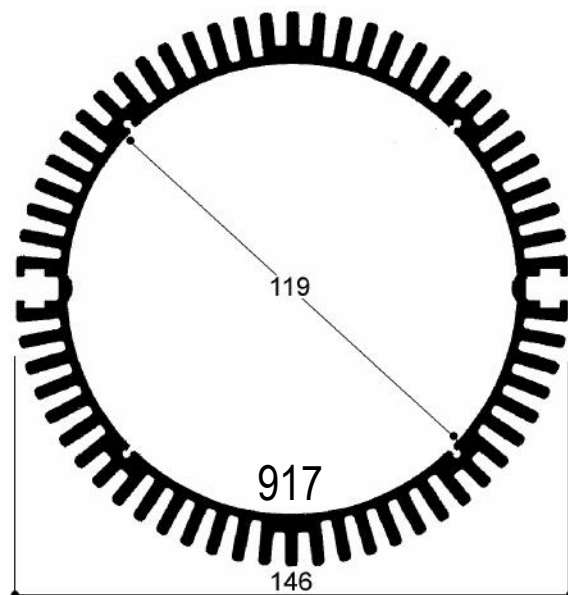
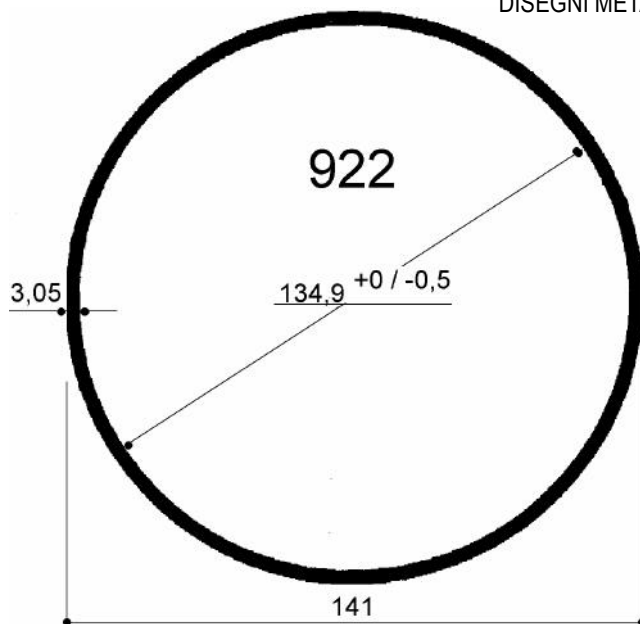

* PROFILO RISERVATO

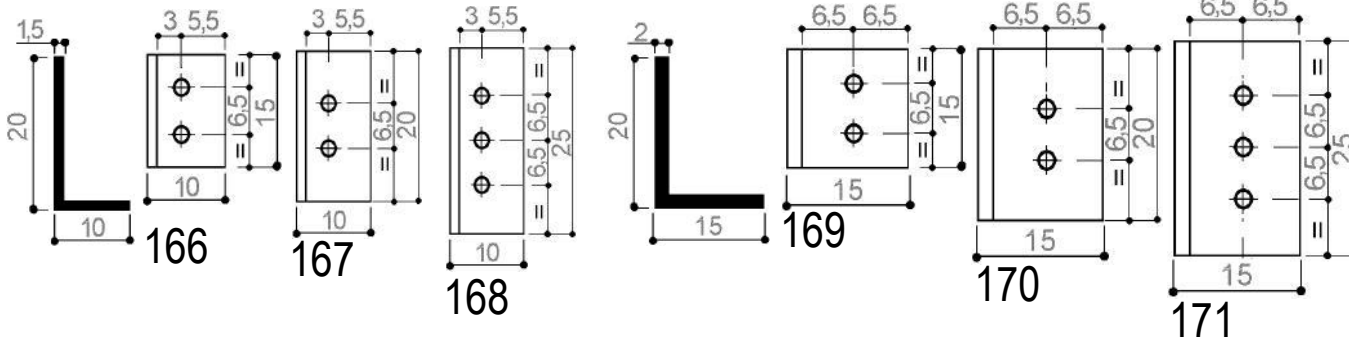
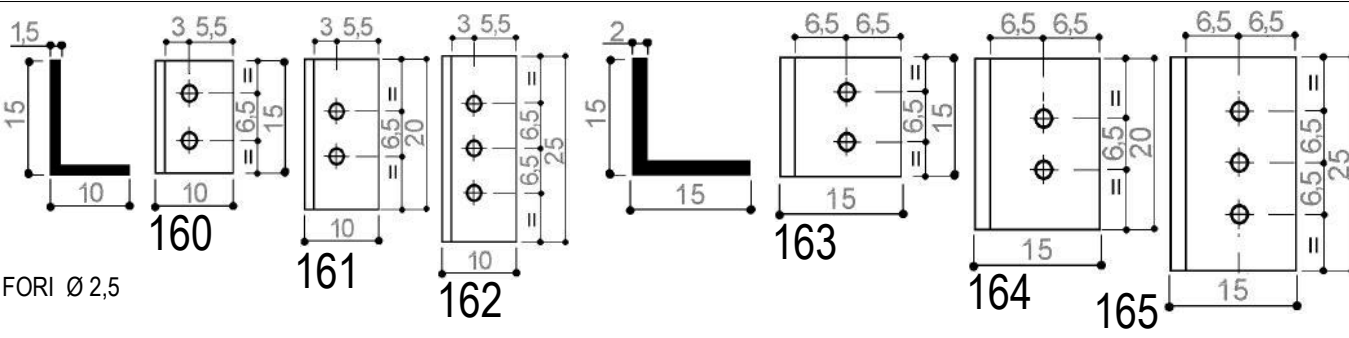
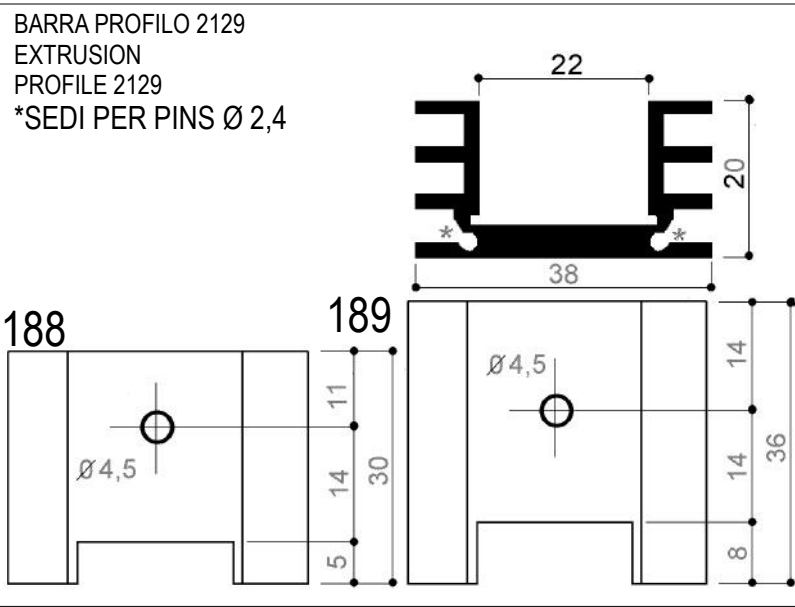
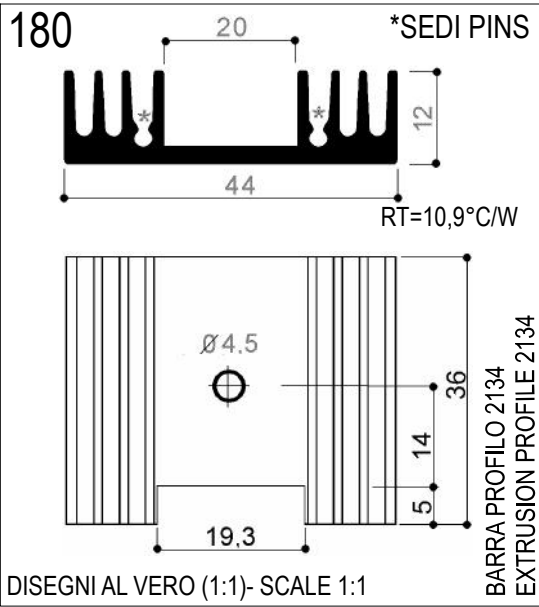
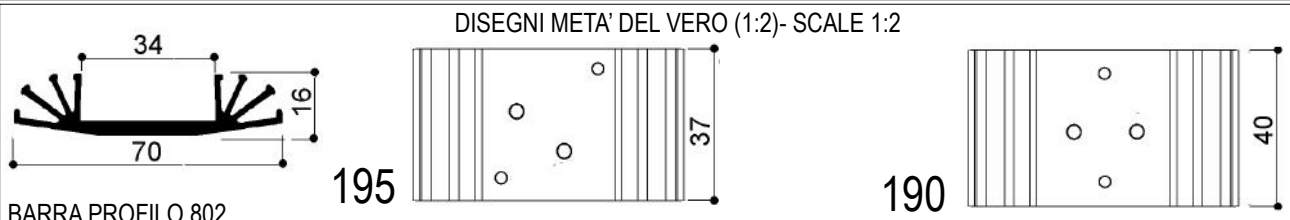
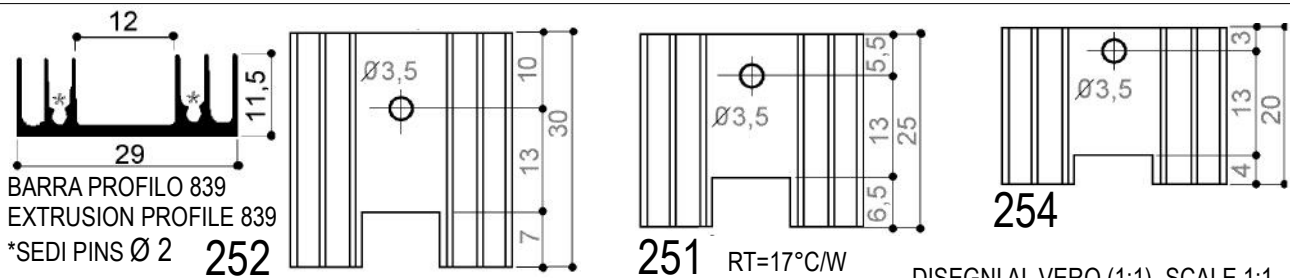

Via Newton, n.12
20016 Pero (Milano - Italy)
Tel. +39 02 3535955 r.a. Fax. +39 02 3539929
E-Mail: info@omar-alluminio.it

Cataloghi Online: www.omar-alluminio.it
www.omar-alluminio.com

PROFILATI ALLUMINIO A DISEGNO / STANDARD / SPECIALI / E PER:
ELETTRONICA / LED / FOTOVOLTAICO / AUTOMAZIONE ROBOTICA / PNEUMATICA / AUTOMOTIVE



DISEGNI AL VERO (1:1)- SCALE 1:1

DOVE NON INDICATO I FORI SONO Ø 3,5 - HOLES Ø 3,5

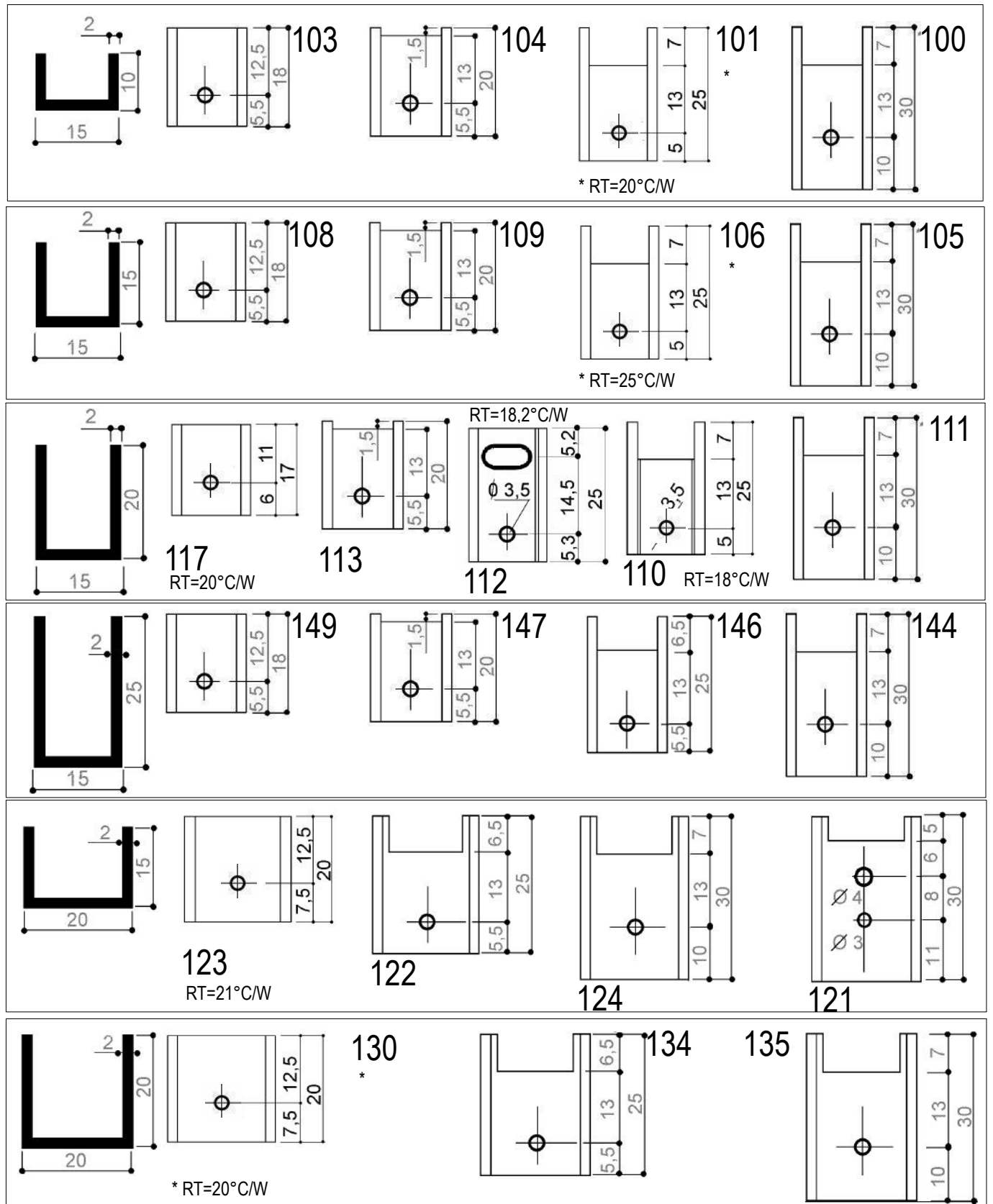

Viti autofilettanti speciali con testa a diametro ridotto e taglio a croce. Adatte per il fissaggio verticale dei dissipatori Art.2129,2134, 809,447

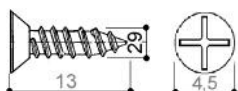
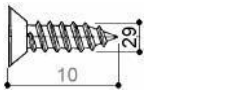
Cod. VTTS+2,9X13
 Cod. VTTS+2,9X10

CODICE ARTICOLO CON P=FORNITO DI PINS Ø 2,3

RT=12°C/W

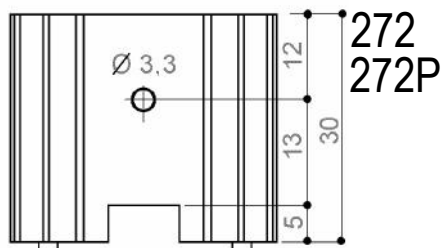
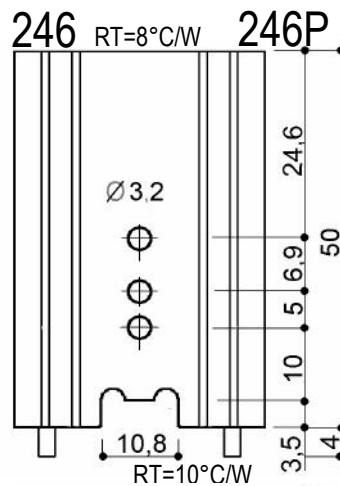
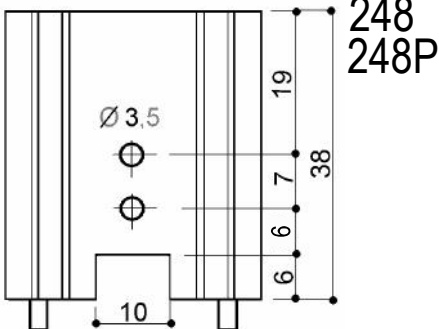
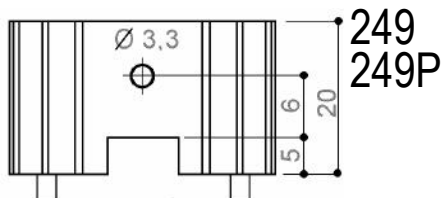

RT=10°C/W

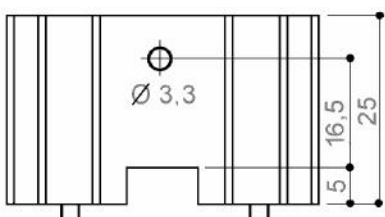
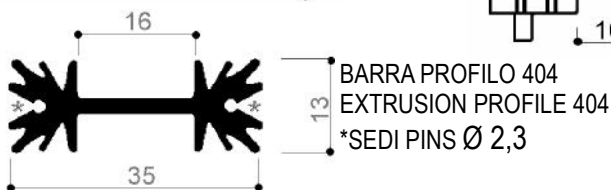
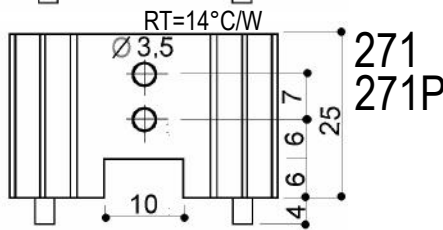
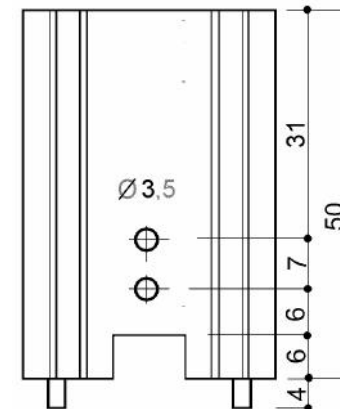
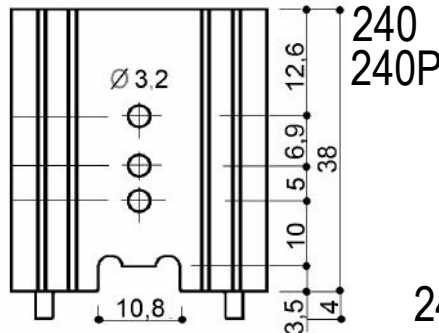

244 244P

DISEGNI AL VERO (1:1)- SCALE 1:1

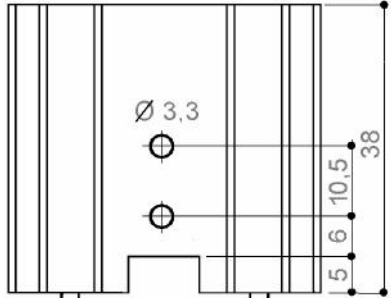

243 243P

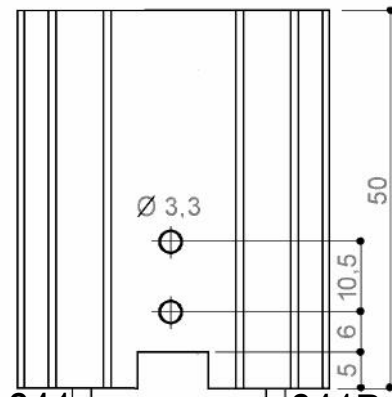

241 241P

RICAVATO DA PROFILO 447

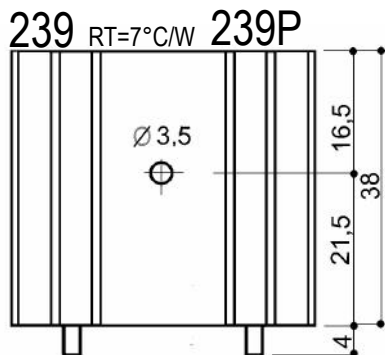

239 RT=7°C/W 239P

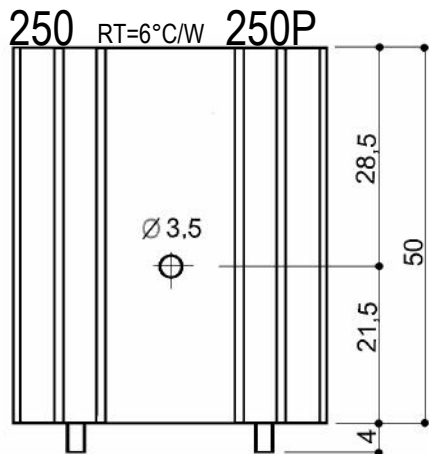

250 RT=6°C/W 250P

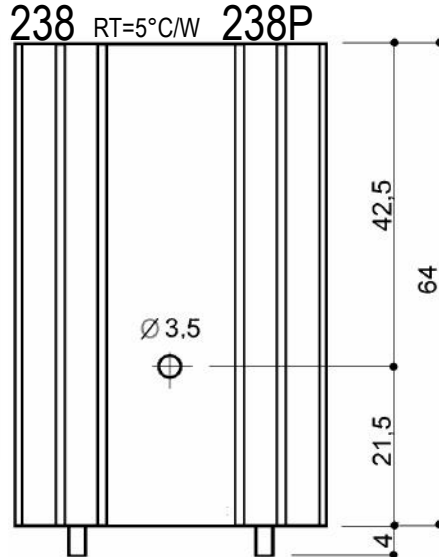

238 RT=5°C/W 238P

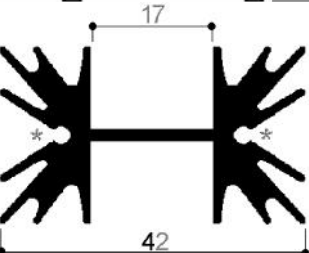

*SEDI PINS Ø 2,3
CODICE ARTICOLO
CON P=FORNITO DI PINS Ø 2,3

-RIPRODUZIONE VIETATA-
AGGIORNAMENTO CONTINUO - ED. DEL 03-2023

Cataloghi Online: www.omar-alluminio.it

www.omar-alluminio.com

PROFILATI ALLUMINIO A DISEGNO / STANDARD / SPECIALI / E PER:

ELETRONICA / LED / FOTOVOLTAICO / AUTOMAZIONE ROBOTICA / PNEUMATICA / AUTOMOTIVE

Via Newton, n.12

20016 Pero (Milano - Italy)

Tel. +39 02 3535955 r.a. Fax. +39 02 3539929

E-Mail: info@omar-alluminio.it



Profili per Stand

Per gli accessori passare a pag.148



DISEGNI AL VERO (1:1)- SCALE 1:1

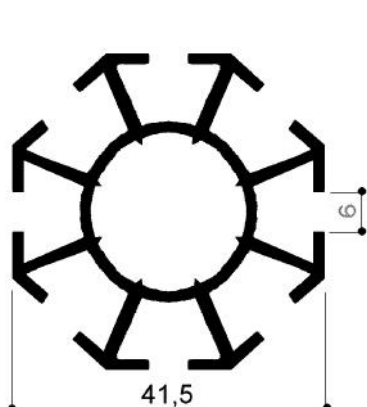

1002

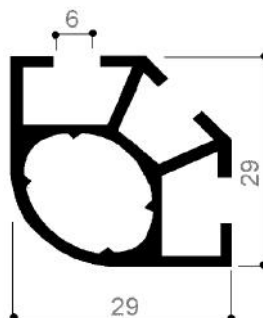

1008

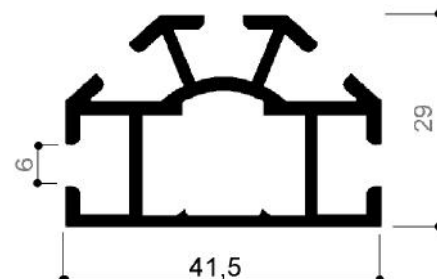

1013

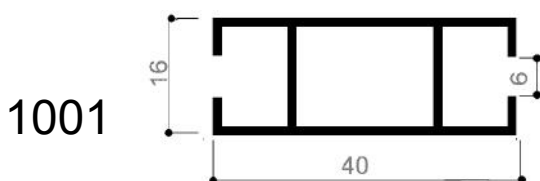

1001

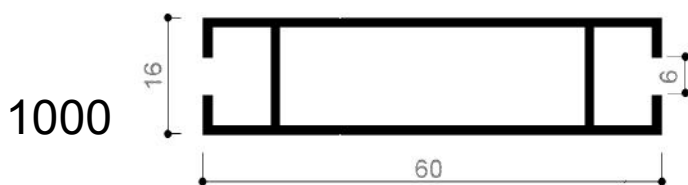

1000

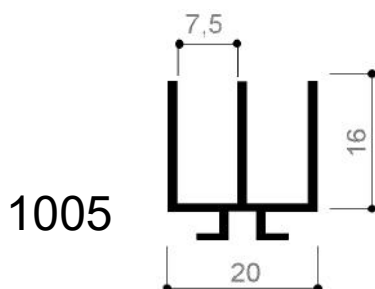

1005

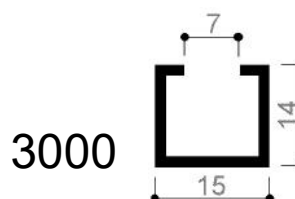

3000

Via Newton, n.12

20016 Pero (Milano - Italy)

Tel. +39 02 3535955 r.a. Fax. +39 02 3539929

E-Mail: info@omar-alluminio.it

Cataloghi Online: www.omar-alluminio.it

www.omar-alluminio.com

PROFILATI ALLUMINIO A DISEGNO / STANDARD / SPECIALI / E PER:

ELETTRONICA / LED / FOTOVOLTAICO / AUTOMAZIONE ROBOTICA / PNEUMATICA / AUTOMOTIVE

OMAR s.p.a.
PROFILATI ALLUMINIO
ALTA TECNOLOGIA

Profili componibili per banchi e linee modulari

Profili strutturali - Extruded aluminium sections for modular systems

Gamma completa per:

- Profili in alluminio con ossidazione naturale in barre o tagliati a misura
 - Accessori adatti alla realizzazione di strutture modulari
- (passare a pag.137 per la descrizione degli accessori)

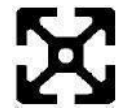

SERIE
20

DISEGNI META' DEL VERO (1:2)

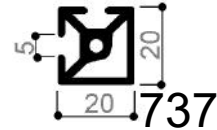
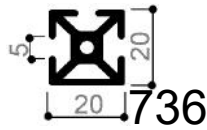
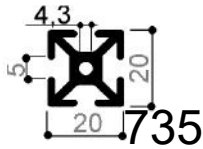

FORI PER
FILETTO M5

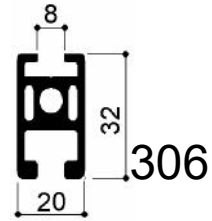
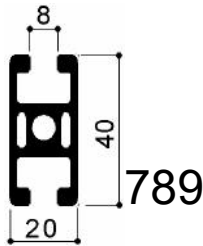
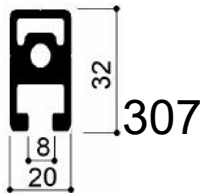

Profili componibili per banchi e linee modulari

Profili strutturali - Extruded aluminium sections for modular systems

Gamma completa per:

- Profili in alluminio con ossidazione naturale in barre o tagliati a misura
 - Accessori adatti alla realizzazione di strutture modulari
- (passare a pag.135 per la descrizione degli accessori)
- Foro centrale per filettatura tradizionale M8

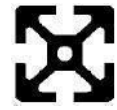

SERIE
30

DISEGNI META' DEL VERO (1:2)- SCALE 1:2

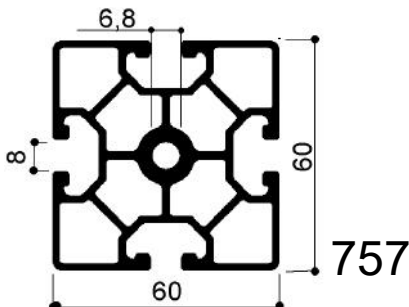
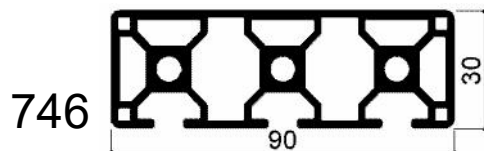
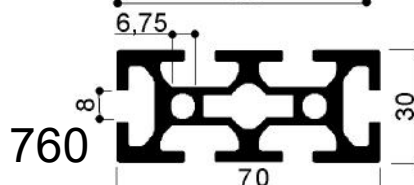
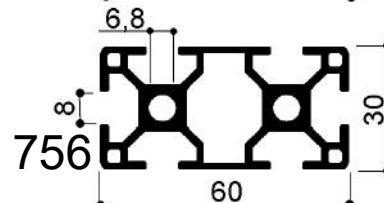
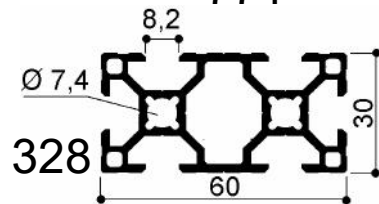
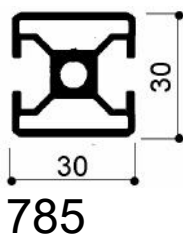
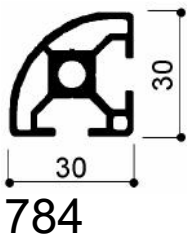
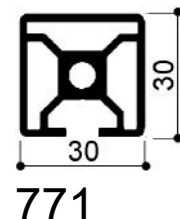
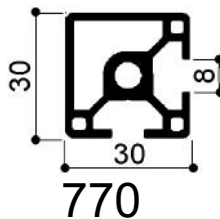
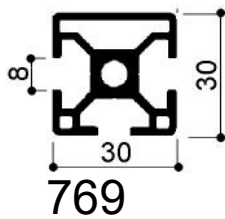
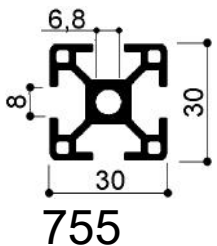

FORI PER FILETTO M8

Profili componibili per banchi e linee modulari

Profili strutturali - Extruded aluminium sections for modular systems

Gamma completa per:

- Profili in alluminio con ossidazione naturale in barre o tagliati a misura
- Accessori adatti alla realizzazione di strutture modulari (passare a pag.137 per la descrizione degli accessori)
- Foro centrale per filettatura tradizionale M8

SERIE
40

DISEGNI META' DEL VERO (1:2) - SCALE 1:2

FORI PER FILETTO M8

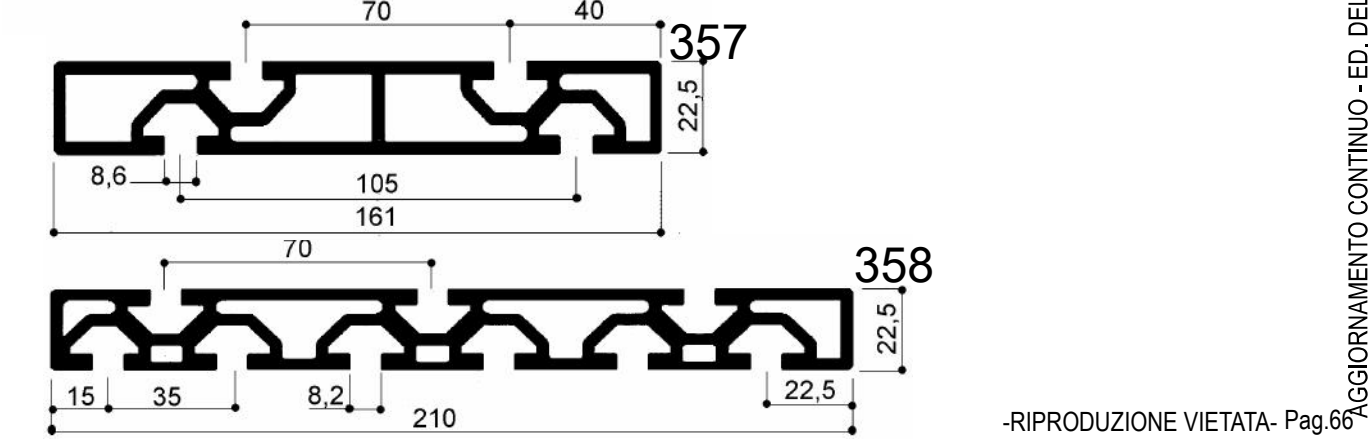
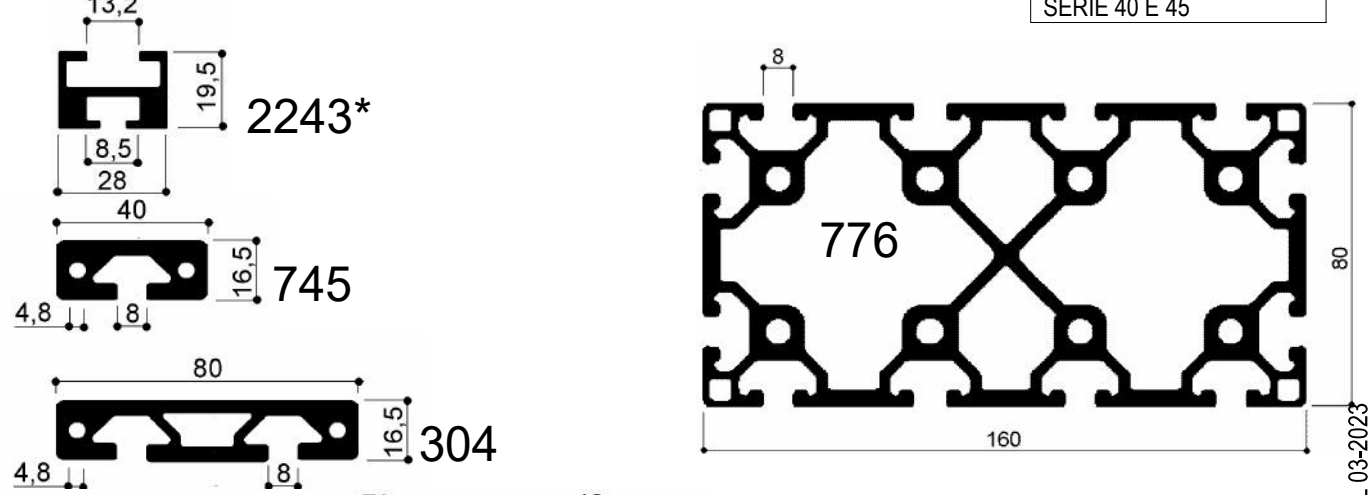
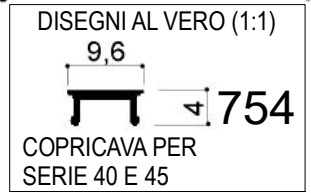
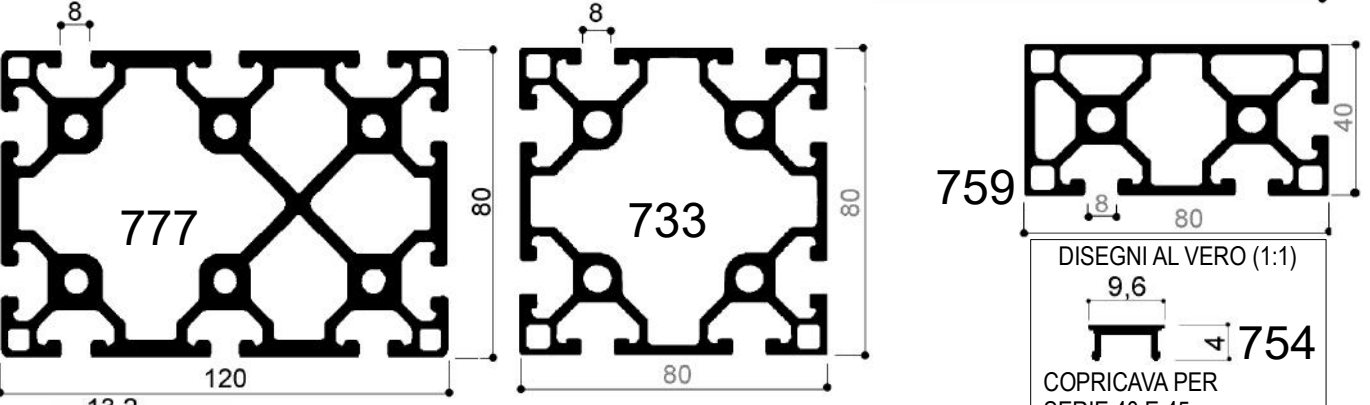
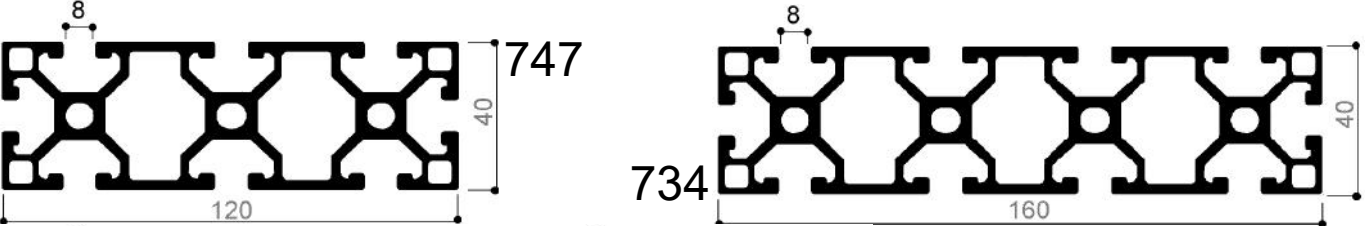
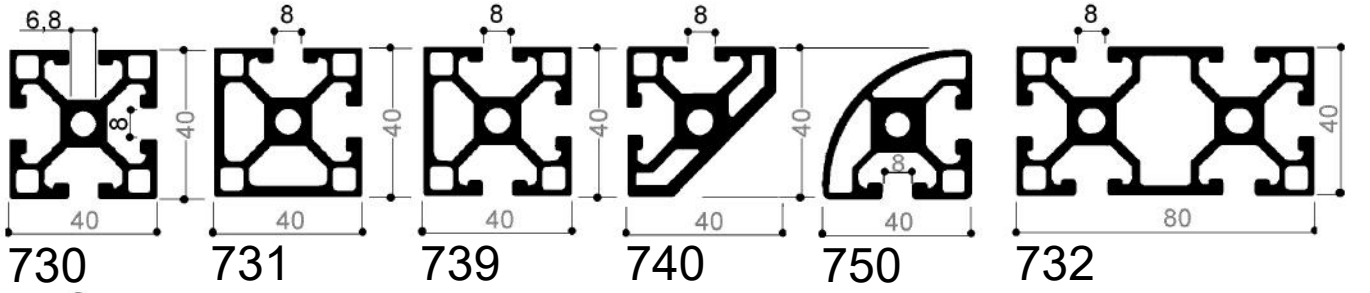

Via Newton, n.12
20016 Pero (Milano - Italy)
Tel. +39 02 3535955 r.a. Fax. +39 02 3539929
E. Mail: info@omar-alluminio.it

Cataloghi Online: www.omar-alluminio.it
www.omar-alluminio.com

PROFILATI ALLUMINIO A DISEGNO / STANDARD / SPECIALI / E PER:
ELETTRONICA / LED / FOTOVOLTAICO / AUTOMAZIONE ROBOTICA / PNEUMATICA / AUTOMOTIVE



AGGIORNAMENTO CONTINUO - ED. DEL 03-2023

Profili componibili per banchi e linee modulari

Profili strutturali - Extruded aluminium sections for modular systems

Gamma completa per:

- Profili in alluminio con ossidazione naturale in barre o tagliati a misura
- Accessori adatti alla realizzazione di strutture modulari (passare a pag.137 per la descrizione degli accessori)
- Foro centrale per filettatura tradizionale M8

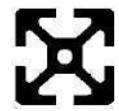

SERIE
40

DISEGNI META' DEL VERO (1:2)

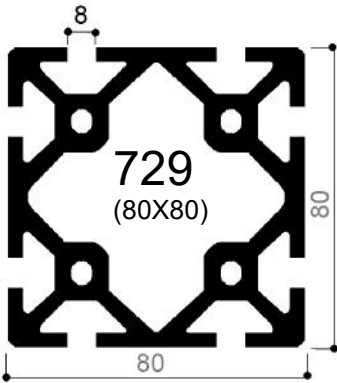
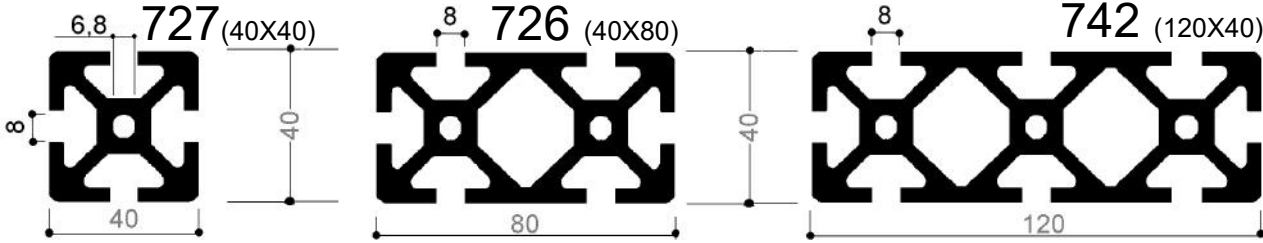

FORI PER
FILETTO M8

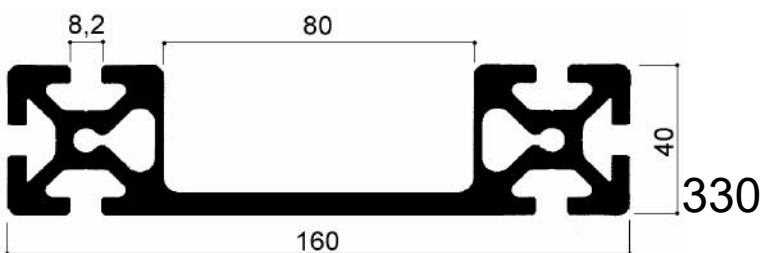
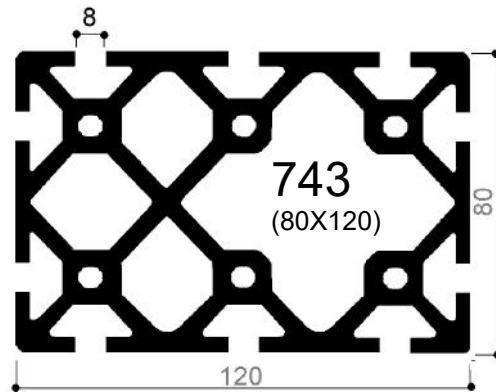
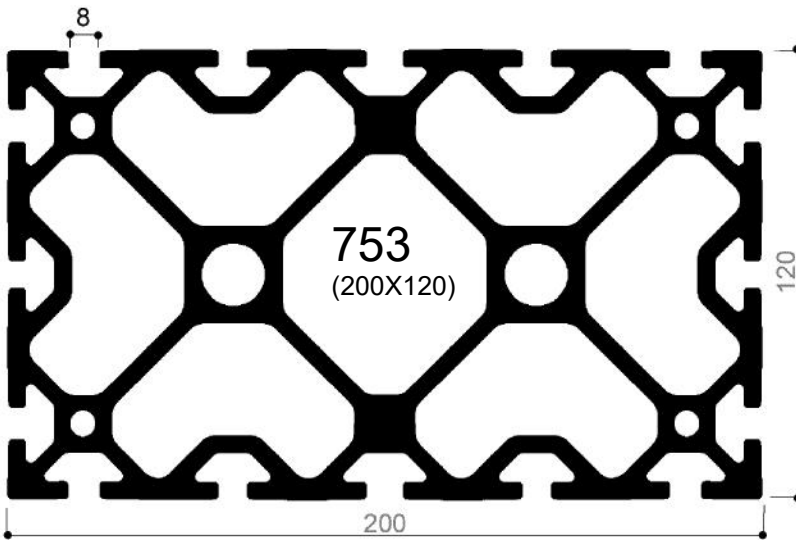
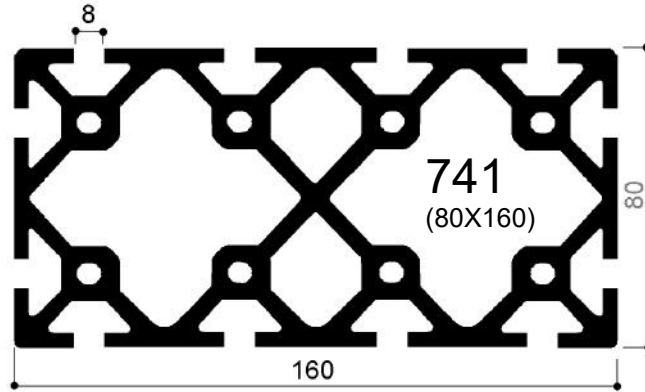

Via Newton, n.12
20016 Pero (Milano - Italy)
Tel.+39 02 3535955 r.a. Fax.+39 02 3539929
E-Mail: info@omar-alluminio.it

Cataloghi Online: www.omar-alluminio.it
www.omar-alluminio.com

PROFILATI ALLUMINIO A DISEGNO / STANDARD / SPECIALI / E PER:
ELETTRONICA / LED / FOTOVOLTAICO / AUTOMAZIONE ROBOTICA / PNEUMATICA / AUTOMOTIVE



Profili componibili per banchi e linee modulari

Profili strutturali - Extruded aluminium sections for modular systems
Gamma completa per:
-Profili in alluminio con ossidazione naturale in barre o tagliati a misura
-Accessori adatti alla realizzazione di strutture modulari (passare a pag.137 per la descrizione degli accessori)
-Foro centrale per filettatura tradizionale M8

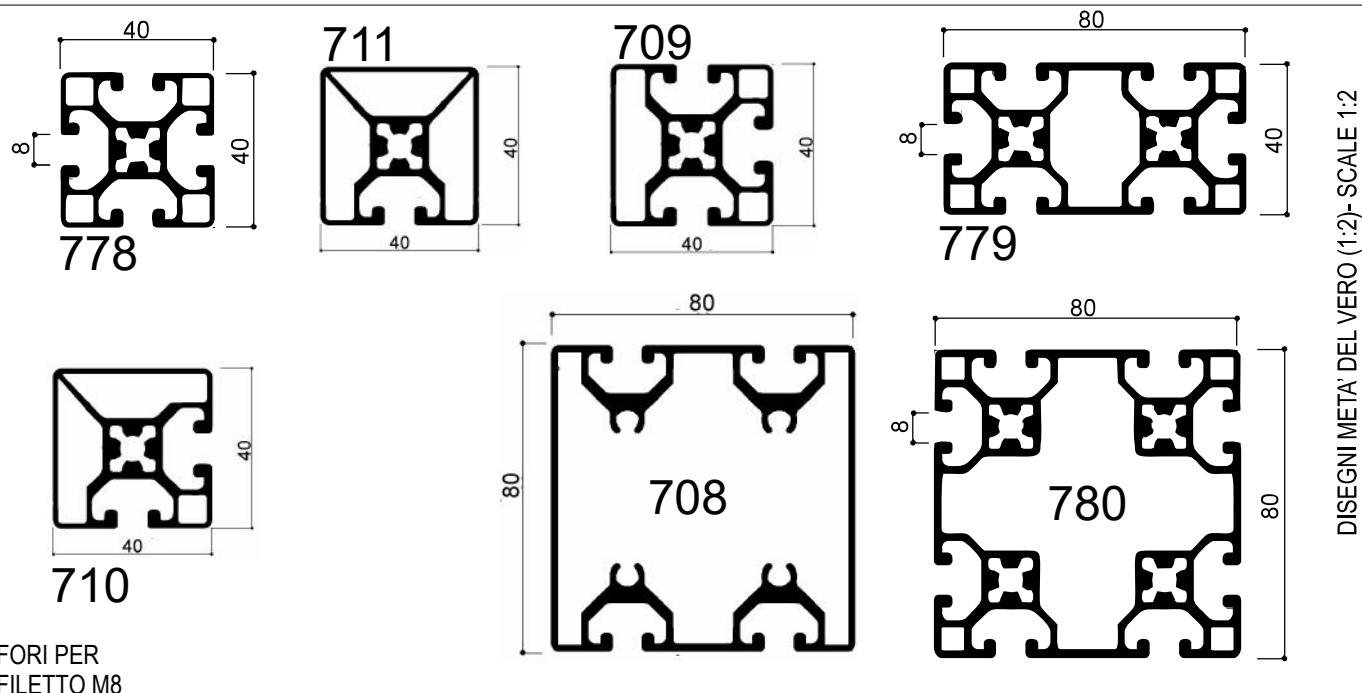

Profili componibili per banchi e linee modulari

Profili strutturali - Extruded aluminium sections for modular systems
Gamma completa per:
-Profili in alluminio con ossidazione naturale in barre o tagliati a misura
-Accessori adatti alla realizzazione di strutture modulari (passare a pag.159 per la descrizione degli accessori)
-Foro centrale per filettatura tradizionale M8

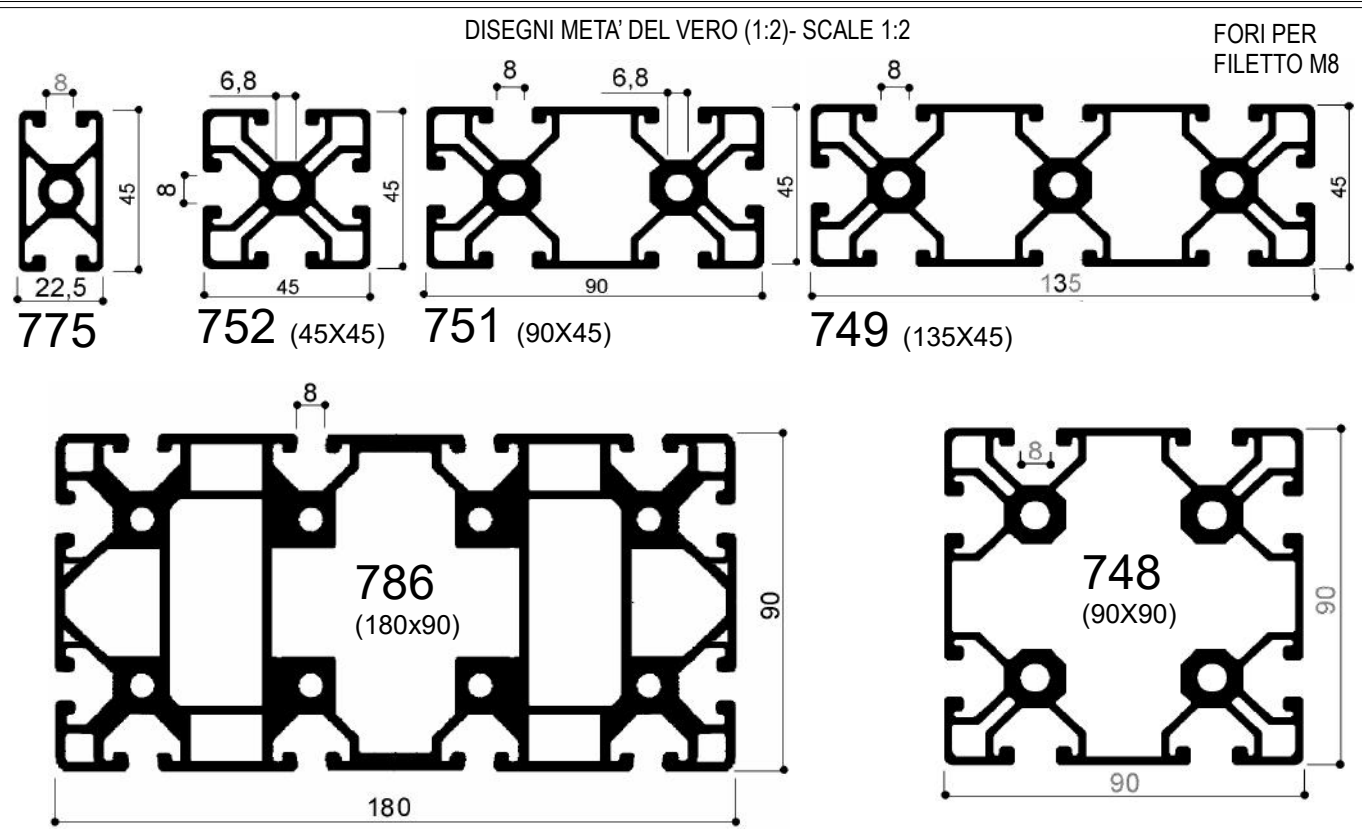

Profili componibili per banchi e linee modulari

Profili strutturali - Extruded aluminium sections for modular systems

Gamma completa per:

- Profili in alluminio con ossidazione naturale in barre o tagliati a misura
 - Accessori adatti alla realizzazione di strutture modulari
- (passare a pag.137 per la descrizione degli accessori)



SERIE
45 CAVA10 LEGGERO

DISEGNI META' DEL VERO (1:2)- SCALE 1:2

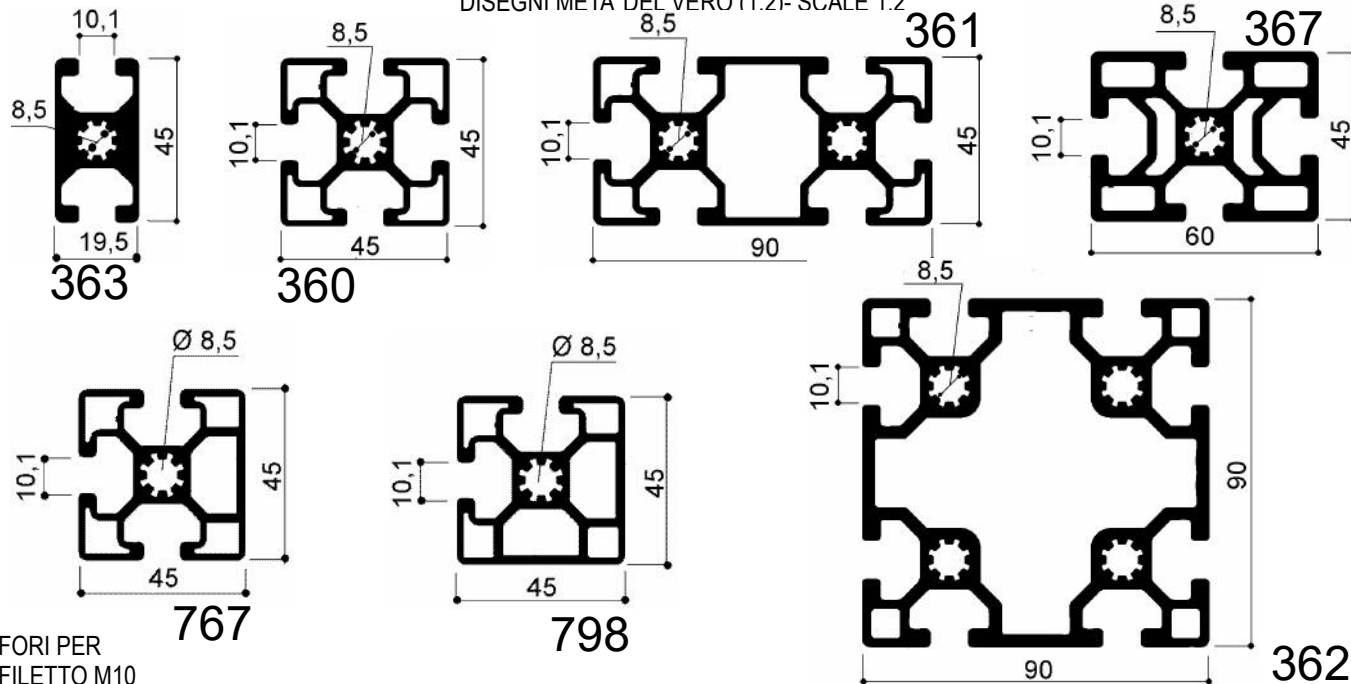

FORI PER
FILETTO M10

Profili componibili per banchi e linee modulari

Profili strutturali - Extruded aluminium sections for modular systems

Gamma completa per:

- Profili in alluminio con ossidazione naturale in barre o tagliati a misura
 - Accessori adatti alla realizzazione di strutture modulari
- (passare a pag.139 per la descrizione degli accessori)



SERIE
45 CAVA10 PESANTE

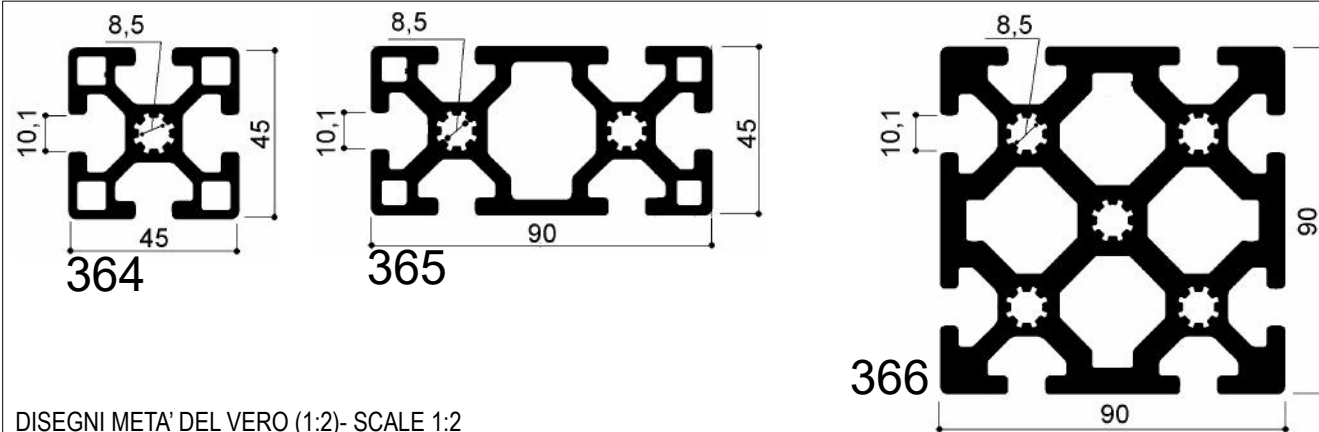

DISEGNI META' DEL VERO (1:2)- SCALE 1:2

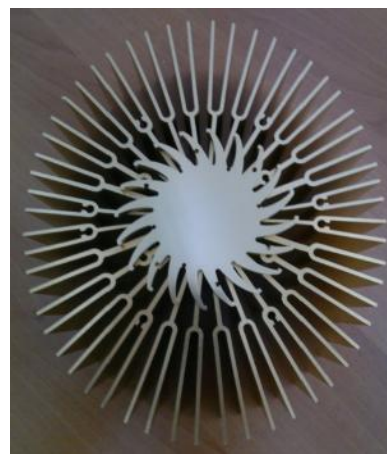
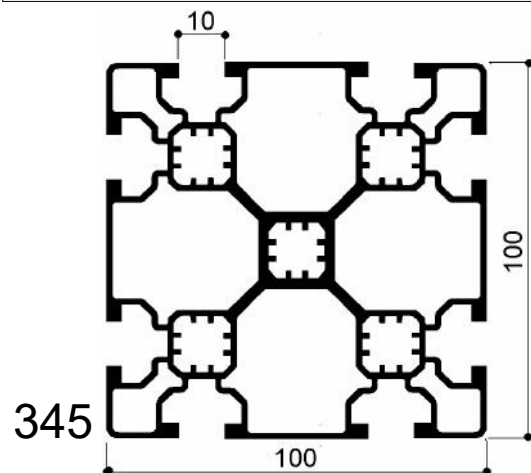

Profili componibili per banchi e linee modulari

Profili strutturali - Extruded aluminium sections for modular systems

Gamma completa per:

-Profili in alluminio con ossidazione naturale in barre o tagliati a misura

-Accessori adatti alla realizzazione di strutture modulari

(passare a pag.137 per la descrizione degli accessori)

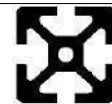

SERIE
VARIE

DISEGNI AL VERO (1:1)- SCALE 1:1

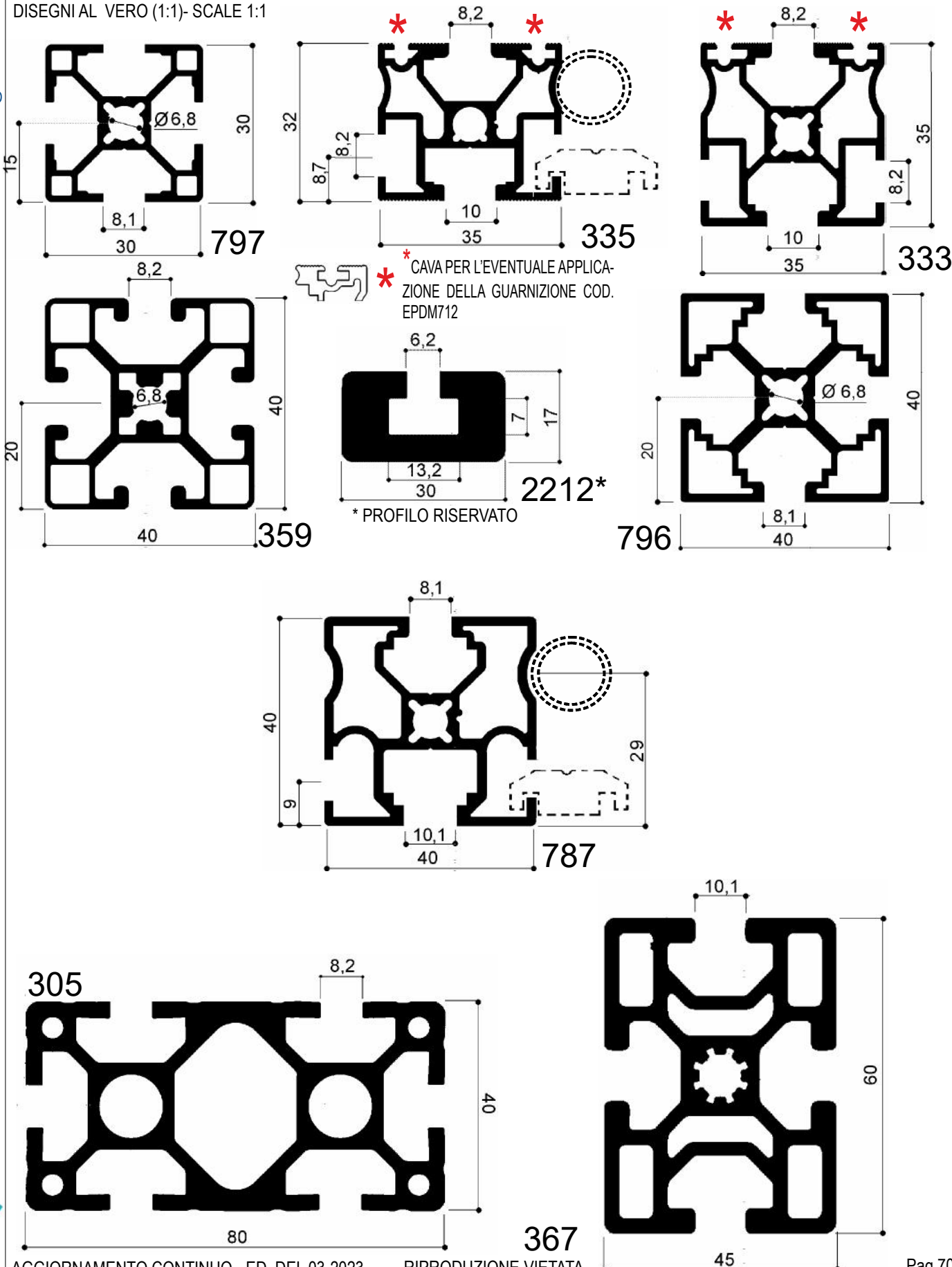

Via Newton, n.12
20016 Pero (Milano - Italy)
Tel. +39 02 3535955 r.a. Fax. +39 02 3539929
E.Mail: info@omar-alluminio.it

Cataloghi Online: www.omar-alluminio.it
www.omar-alluminio.com

PROFILATI ALLUMINIO A DISEGNO / STANDARD / SPECIALI / E PER:
ELETTRONICA / LED / FOTOVOLTAICO / AUTOMAZIONE ROBOTICA / PNEUMATICA / AUTOMOTIVE

OMAR s.r.l.
PROFILATI ALLUMINIO
ALTA TECNOLOGIA



Profili componibili per banchi e linee modulari

Profili strutturali - Caratteristiche statiche

I_x = Momento d'inerzia su asse X

I_y = Momento d'inerzia su asse Y

W_x = Modulo di resistenza su asse X

W_y = Modulo di resistenza su asse Y

I DATI RIPORTATI SONO PURAMENTE INDICATIVI

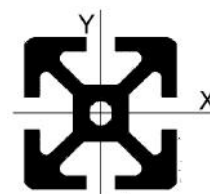

ART.	J_x (cm ⁴)	J_y (cm ⁴)	W_x (cm ³)	W_y (cm ³)	P(g/mt)
360	10,85	10,85	4,82	4,82	1544
361	22,55	86,87	10,02	19,29	2884
362	190,04	190,04	42,22	42,22	5557
363	6,42	3,11	2,85	2,76	1285
364	14,90	14,90	6,92	6,62	2020
365	33,83	120,79	14,58	26,83	4093
366	284,26	284,26	63,16	63,16	9717
367	21,46	35,79	9,53	11,92	2835
708	105,258	91,229	26,305	22,799	3375
709	8,096	7,795	4,048	3,736	1369
710	7,852	7,855	3,849	3,852	1326
711	7,841	7,601	3,891	3,800	1283
726	98,219	26,011	24,555	13,006	4207
727	14,002	14,002	7,001	7,001	2376
729	175,68	175,68	43,92	43,92	6539
730	9,913	9,913	4,957	4,957	1790
731	9,878	9,878	4,921	4,921	1709
732	72,237	18,458	18,059	9,229	3032
733	124,759	124,759	31,19	31,19	4574
734	503,196	35,546	62,899	17,722	5516
735	0,68	0,68	0,68	0,68	459
736	0,64	0,71	0,64	0,68	481
737	0,69	0,69	0,69	0,69	459
739	9,786	10,005	4,888	4,979	1749
740	6,41	6,41	2,777	2,777	1401
741	1147,892	335,465	143,483	83,868	12290
742	311,220	38,96	51,897	19,481	6032
743	529,588	253,727	85,922	63,417	9642
747	27,002	224,416	13,501	37,403	4277
748	148,255	148,255	32,946	32,946	4112
749	276,197	32,675	40,918	14,522	3969
750	6,809	6,808	3,044	3,052	1463
751	22,472	90,373	9,968	20,082	2878
752	12,4	12,4	5,511	5,511	1787
753	3022,650	1208,716	302,264	201,453	20260
755	2,85	2,85	1,9	1,9	872
756	4,994	20,149	3,329	6,716	1490
757	35,400	35,400	11,800	11,800	2680
759	19,493	75,379	9,525	18,63	3140
760	8,596	42,024	5,731	12,007	2376
769	2,929	2,741	1,942	1,827	867
770	2,883	2,882	1,904	1,902	853
771	2,811	3,05	1,823	2,033	891
775	6,519	2,292	2,897	2,197	1800
776	269,634	899,676	67,399	112,46	9731
777	205,015	422,99	51,248	68,556	7825
778	7,132	7,132	3,564	3,564	1318
779	15,151	59,684	7,576	14,921	2432
780	103,553	103,553	25,888	25,888	3846
784	2,177	2,175	1,341	1,338	778
785	3,002	2,634	2	1,756	861
786	1444,094	395,108	160,438	87,793	12050

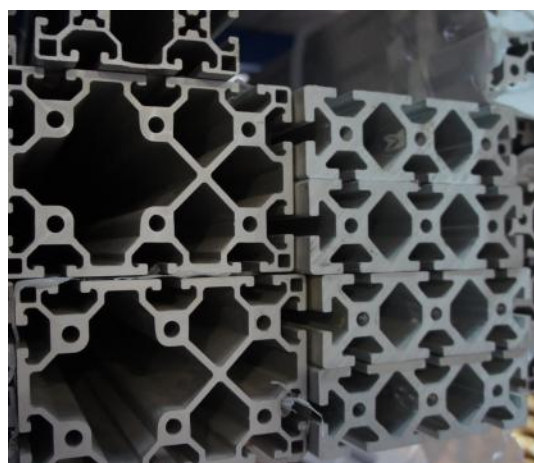

Via Newton, n.12
20016 Pero (Milano - Italy)
Tel. +39 02 3535955 r.a. Fax. +39 02 3539929
E-Mail: info@omar-alluminio.it

Cataloghi Online: www.omar-alluminio.it
www.omar-alluminio.com

PROFILATI ALLUMINIO A DISEGNO / STANDARD / SPECIALI / E PER:
ELETTRONICA / LED / FOTOVOLTAICO / AUTOMAZIONE ROBOTICA / PNEUMATICA / AUTOMOTIVE



Profili componibili per banchi e linee modulari

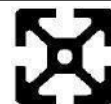

Profili strutturali - Extruded aluminium sections for modular systems

Gamma completa per:

- Profili in alluminio con ossidazione naturale in barre o tagliati a misura
- Accessori adatti alla realizzazione di strutture modulari (passare a pag.137 per la descrizione degli accessori)

Via Newton, n.12
20016 Pero (Milano - Italy)
Tel. +39 02 3535955 r.a. Fax. +39 02 3539929
E-Mail: info@omar-alluminio.it

Cataloghi Online: www.omar-alluminio.it
www.omar-alluminio.com

PROFILATI ALLUMINIO A DISEGNO / STANDARD / SPECIALI / E PER:
ELETTRONICA / LED / FOTOVOLTAICO / AUTOMAZIONE ROBOTICA / PNEUMATICA / AUTOMOTIVE

DISEGNI META' DEL VERO

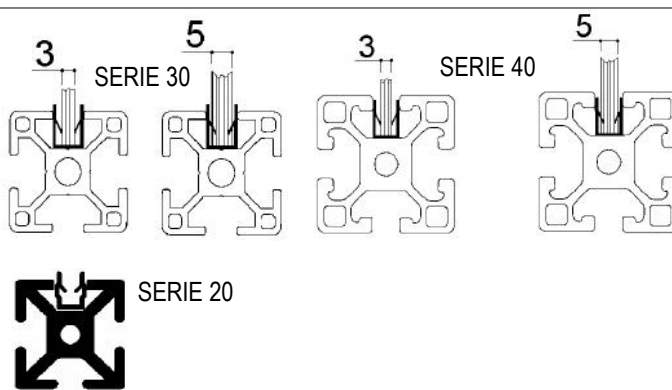
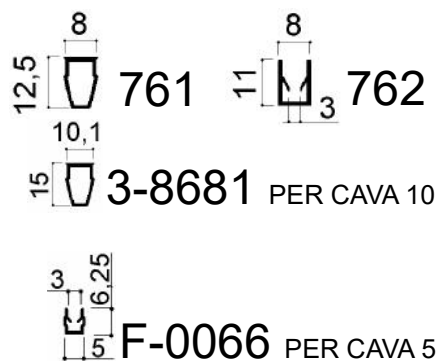

AMBITO DI LAVORO DA 2 - 2,5mm AMBITO DI LAVORO DA 3 - 3,5mm AMBITO DI LAVORO DA 4 - 4,5mm AMBITO DI LAVORO DA 6 - 8,0mm

MATERIALE P.V.C. NERO

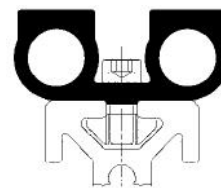
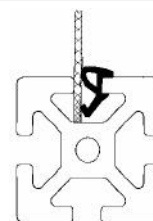

DISEGNI META' DEL VERO (1:2)

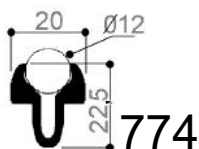

PROFILATO PORTA TONDINO

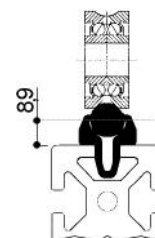

DISEGNI AL VERO (1:1)

PROFILATO PORTA CAVI

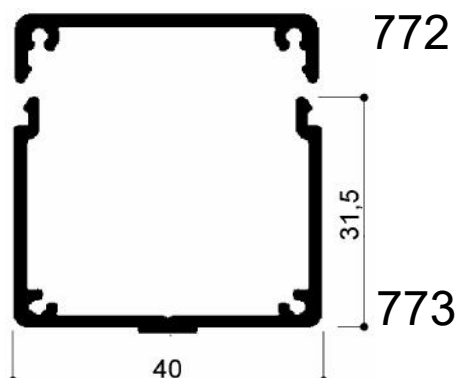

PROFILATO PER GUIDE DI FINE CORSA DISEGNI META' DEL VERO (1:2)- SCALE 1:2

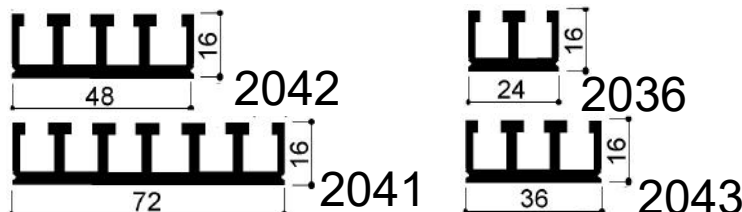

3-TAS/P 3-TAS/G



Profili componibili modulari in alluminio

Extruded aluminium profiles for modular systems

-Profili in alluminio ossidati naturale fornibili in barre o tagliati a misura

-ACCESSORI vedi pag. 147



DISEGNI AL VERO (1:1)

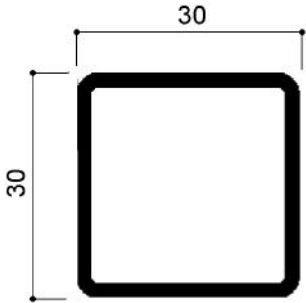
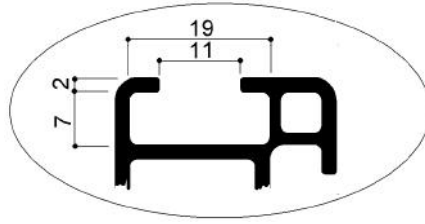

720

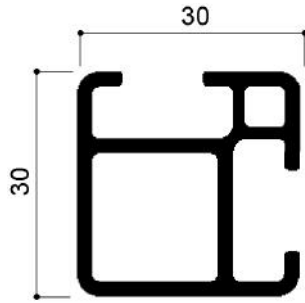

724

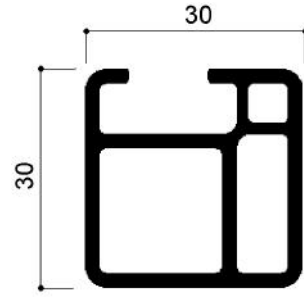

725

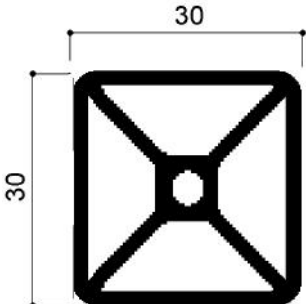

FORO PER FILETTO M5

721

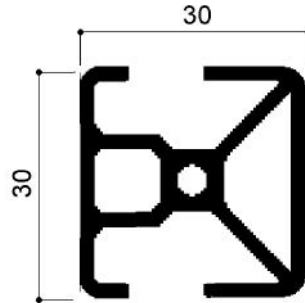

FORO PER FILETTO M5

723

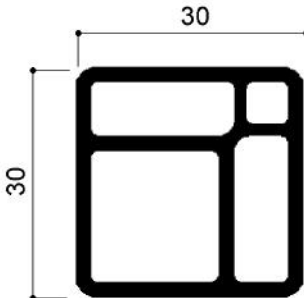

722

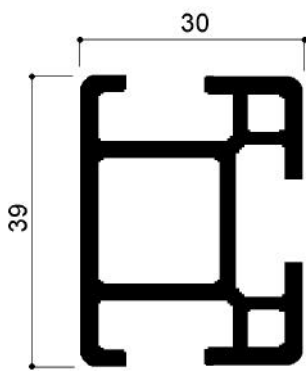

719

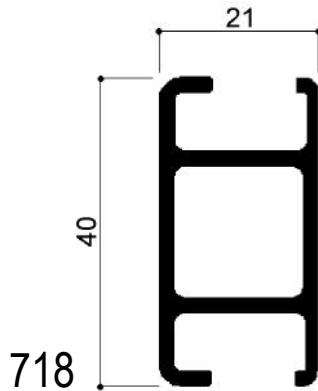

718

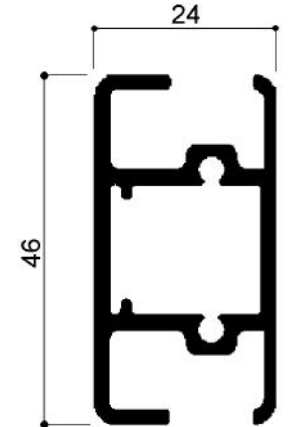

717

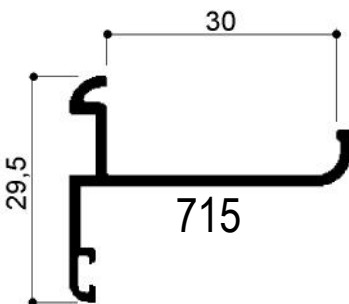

715

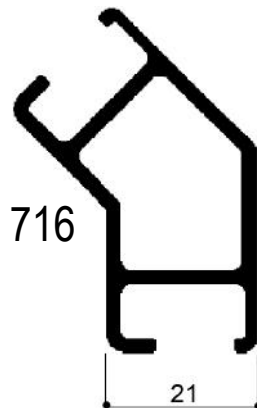

716

Via Newton, n.12

20016 Pero (Milano - Italy)

Tel. +39 02 3535955 r.a. Fax. +39 02 3539929

E-Mail: info@omar-alluminio.it

Cataloghi Online: www.omar-alluminio.it

www.omar-alluminio.com

PROFILATI ALLUMINIO A DISEGNO / STANDARD / SPECIALI / E PER:

ELETTRONICA / LED / FOTOVOLTAICO / AUTOMAZIONE ROBOTICA / PNEUMATICA / AUTOMOTIVE



Profilati in alluminio / Travi / Longheroni

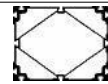

DISEGNI META' DEL VERO (1:2)

Via Newton, n.12
20016 Pero (Milano - Italy)
Tel. +39 02 3535955 r.a. Fax. +39 02 3539929
E-Mail: info@omar-alluminio.it

Cataloghi Online: www.omar-alluminio.it
www.omar-alluminio.com
PROFILATI ALLUMINIO A DISEGNO / STANDARD / SPECIALI / E PER:
ELETTRONICA / LED / FOTOVOLTAICO / AUTOMAZIONE ROBOTICA / PNEUMATICA / AUTOMOTIVE

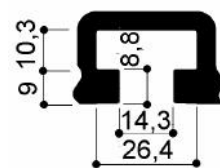
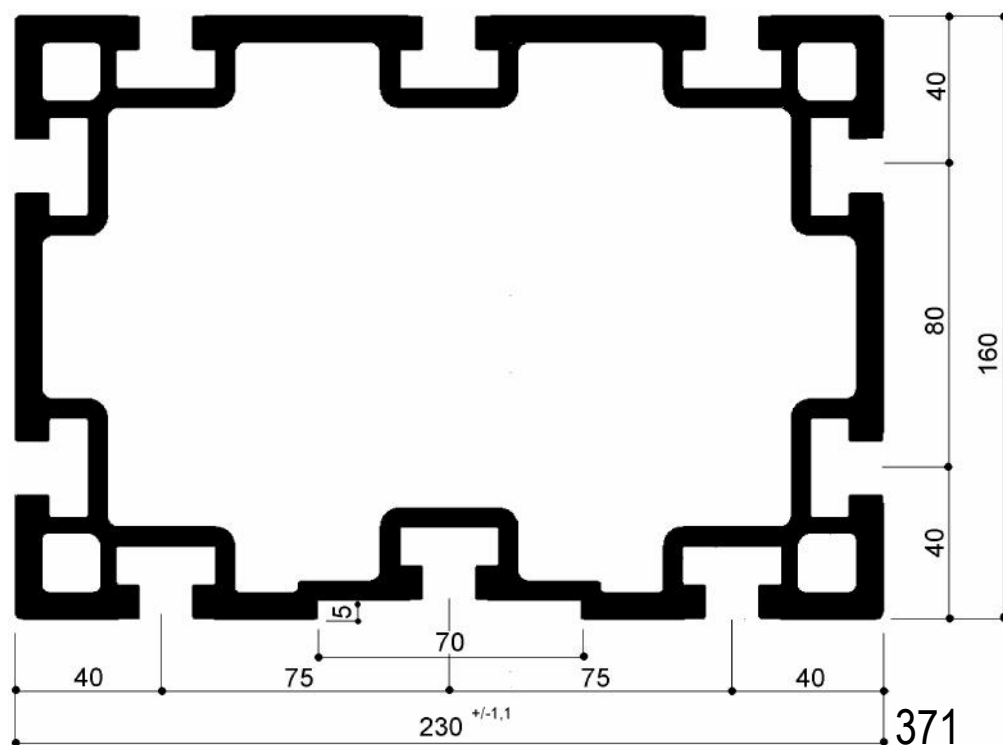
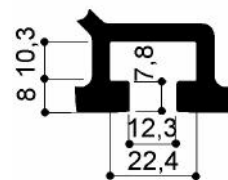
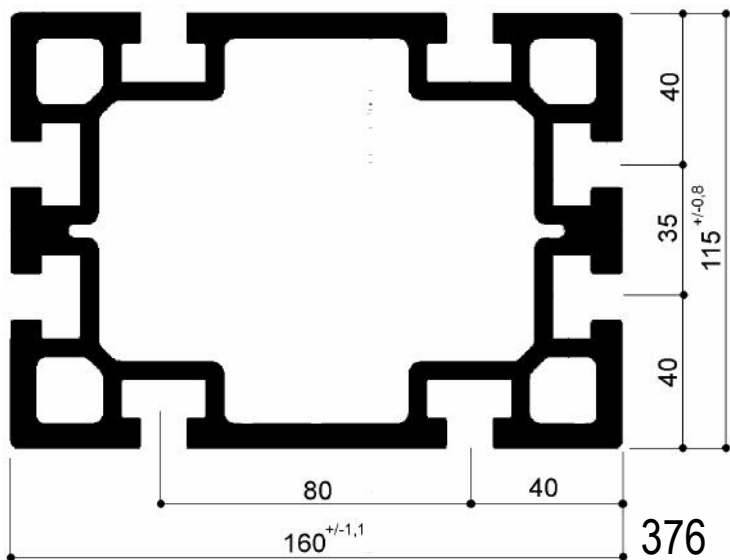
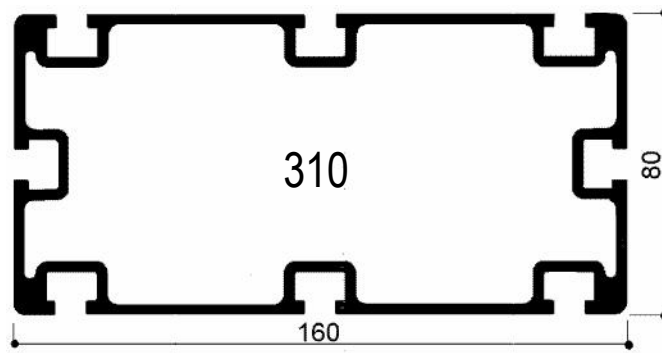
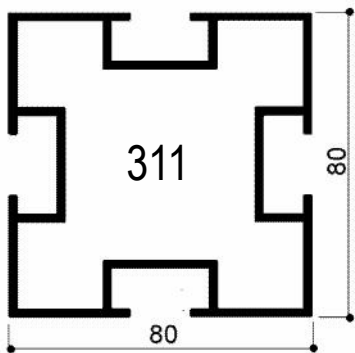

Profilati in alluminio / Travi / Longheroni

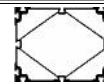

DISEGNI META' DEL VERO (1:2)

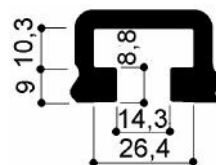
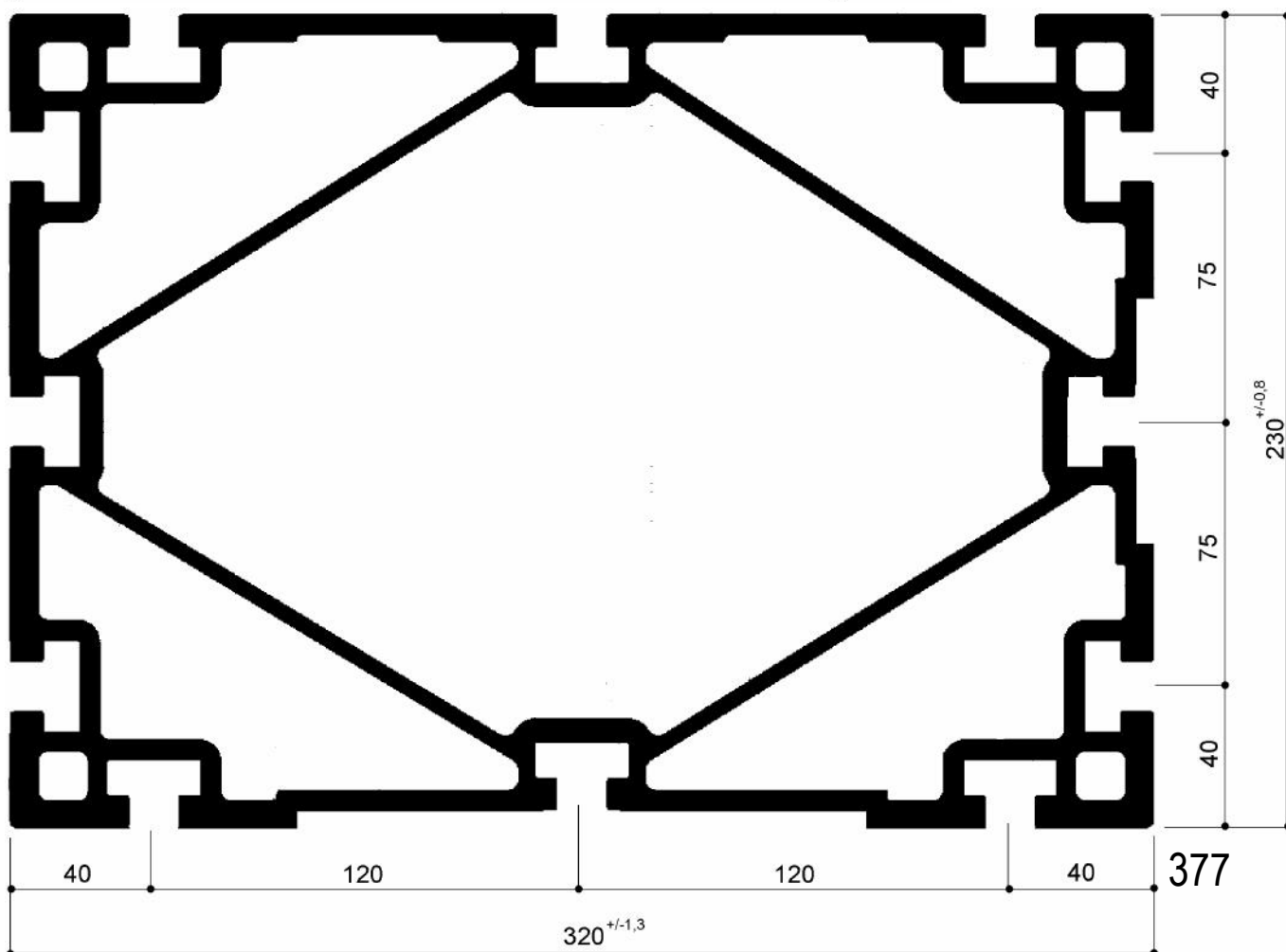
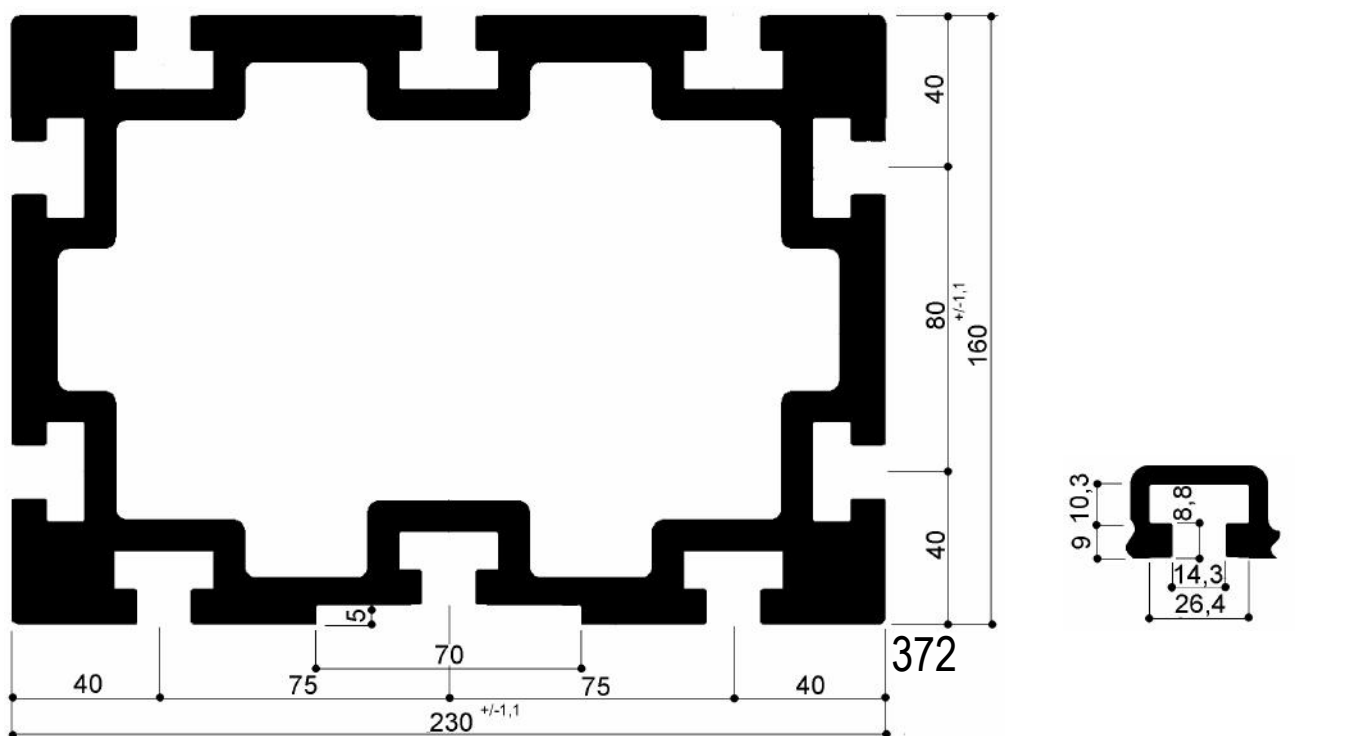

Via Newton, n.12
20016 Pero (Milano - Italy)
Tel. +39 02 3535955 r.a. Fax. +39 02 3539929
E-Mail: info@omar-alluminio.it

Cataloghi Online: www.omar-alluminio.it
www.omar-alluminio.com

PROFILATI ALLUMINIO A DISEGNO / STANDARD / SPECIALI / E PER:
ELETTRONICA / LED / FOTOVOLTAICO / AUTOMAZIONE ROBOTICA / PNEUMATICA / AUTOMOTIVE



Profilati in alluminio / Travi / Longheroni

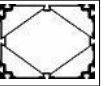

DISEGNI META' DEL VERO (1:2)

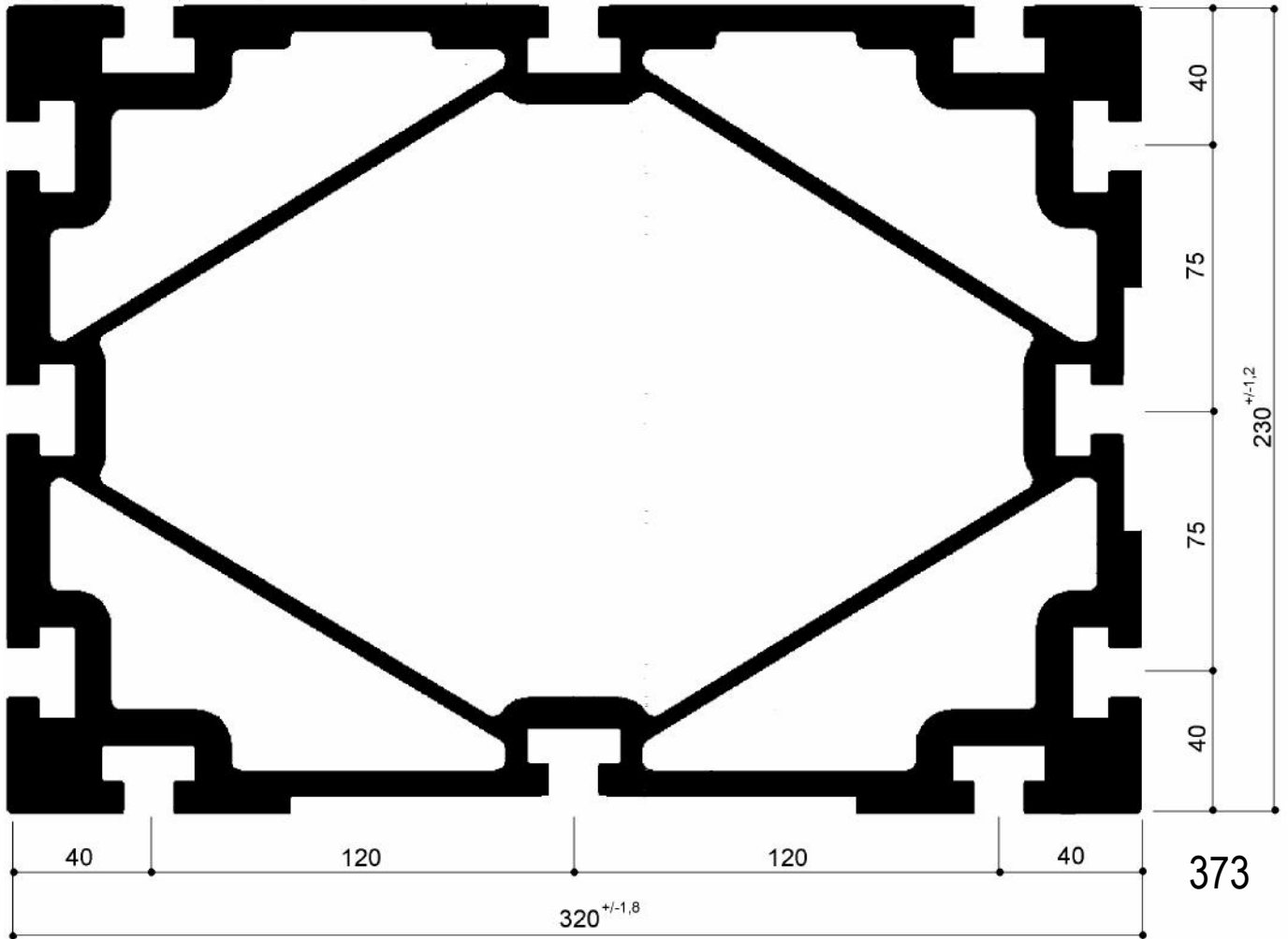

E' possibile fornire barre in lunghezza MASSIMA di 10 mt.

FOTO DI ESEMPIO: UNA DELLE TRE LINEE DI TAGLIO A MISURA DI PROFILI IN ALLUMINIO ESTRUSO



E' possibile fornire barre in lunghezza MASSIMA di 10 mt.

AGGIORNAMENTO CONTINUO - ED. DEL 03-2023-RIPRODUZIONE VIETATA-

Cataloghi Online: www.omar-alluminio.it
www.omar-alluminio.com

Via Newton, n.12

20016 Pero (Milano - Italy)

Tel. +39 02 3535955 r.a. Fax. +39 02 3539929

E-Mail: info@omar-alluminio.it

PROFILATI ALLUMINIO A DISEGNO / STANDARD / SPECIALI / E PER:
ELETTRONICA / LED / FOTOVOLTAICO / AUTOMAZIONE ROBOTICA / PNEUMATICA / AUTOMOTIVE

OMAR s.r.l.
PROFILATI ALLUMINIO
ALTA TECNOLOGIA

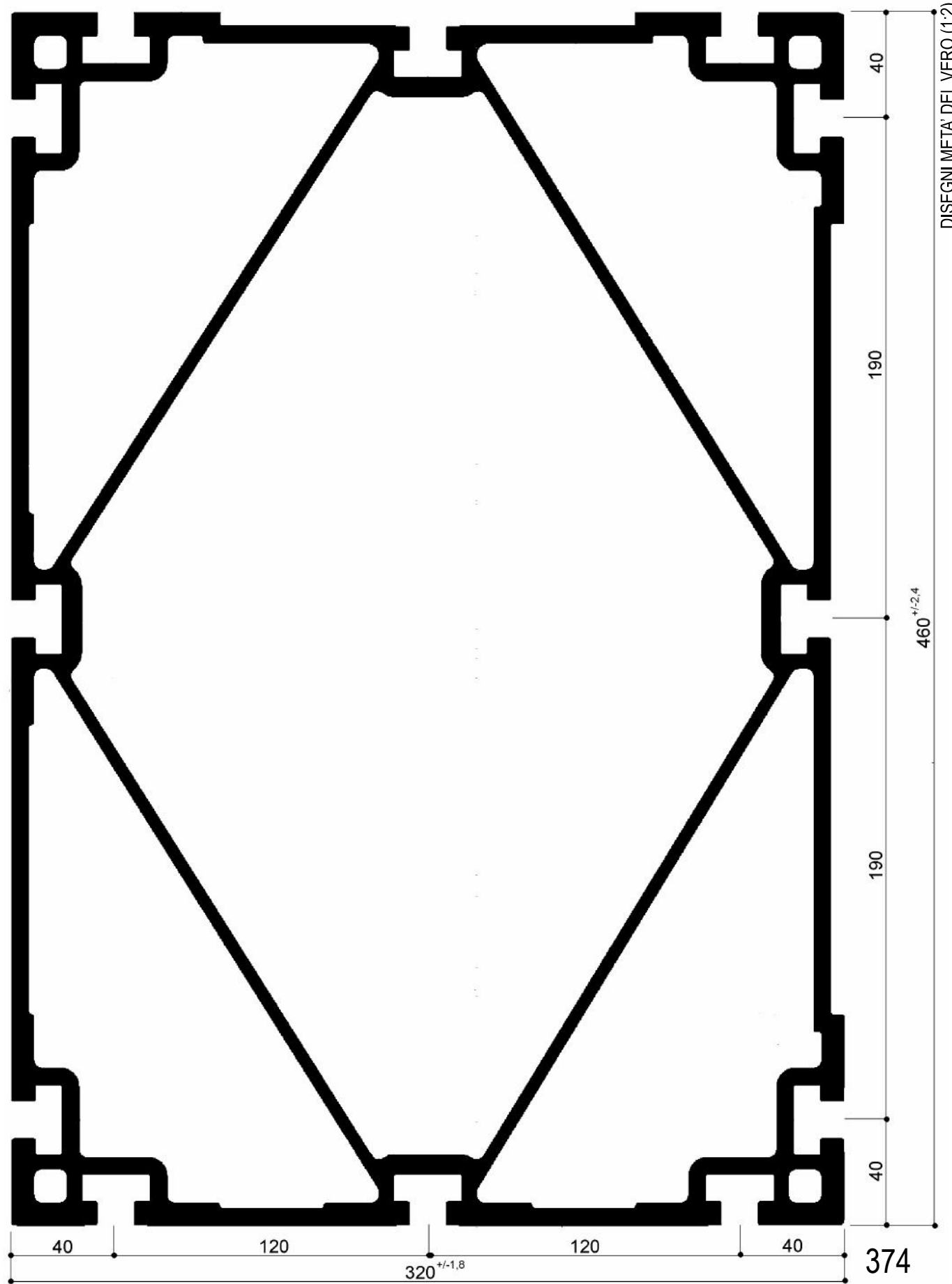
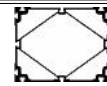

DISEGNI METÀ DEL VERO (1:2)

Cataloghi Online: www.omar-alluminio.it

www.omar-alluminio.com

PROFILATI ALLUMINIO A DISEGNO / STANDARD / SPECIALI / E PER:

ELETTRONICA / LED / FOTOVOLTAICO / AUTOMAZIONE ROBOTICA / PNEUMATICA / AUTOMOTIVE

Via Newton, n.12

20016 Pero (Milano - Italy)

Tel. +39 02 3535955 r.a. Fax. +39 02 3539929

E-Mail: info@omar-alluminio.it



E' possibile fornire barre in lunghezza MASSIMA di 10 mt.

AGGIORNAMENTO CONTINUO - ED. DEL 03-2023

-RIPRODUZIONE VIETATA-

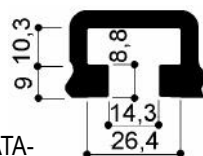

Profilati in alluminio/ Travi / Longheroni

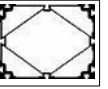

Cataloghi Online: www.omar-alluminio.it
www.omar-alluminio.com

Via Newton, n.12
 20016 Pero (Milano - Italy)
 Tel. +39 02 3535955 r.a. Fax. +39 02 3539929
 E.Mail: info@omar-alluminio.it

PROFILATI ALLUMINIO A DISEGNO / STANDARD / SPECIALI / E PER:
 ELETTRONICA / LED / FOTOVOLTAICO / AUTOMAZIONE ROBOTICA / PNEUMATICA / AUTOMOTIVE

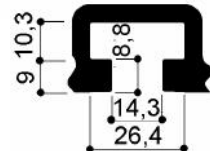
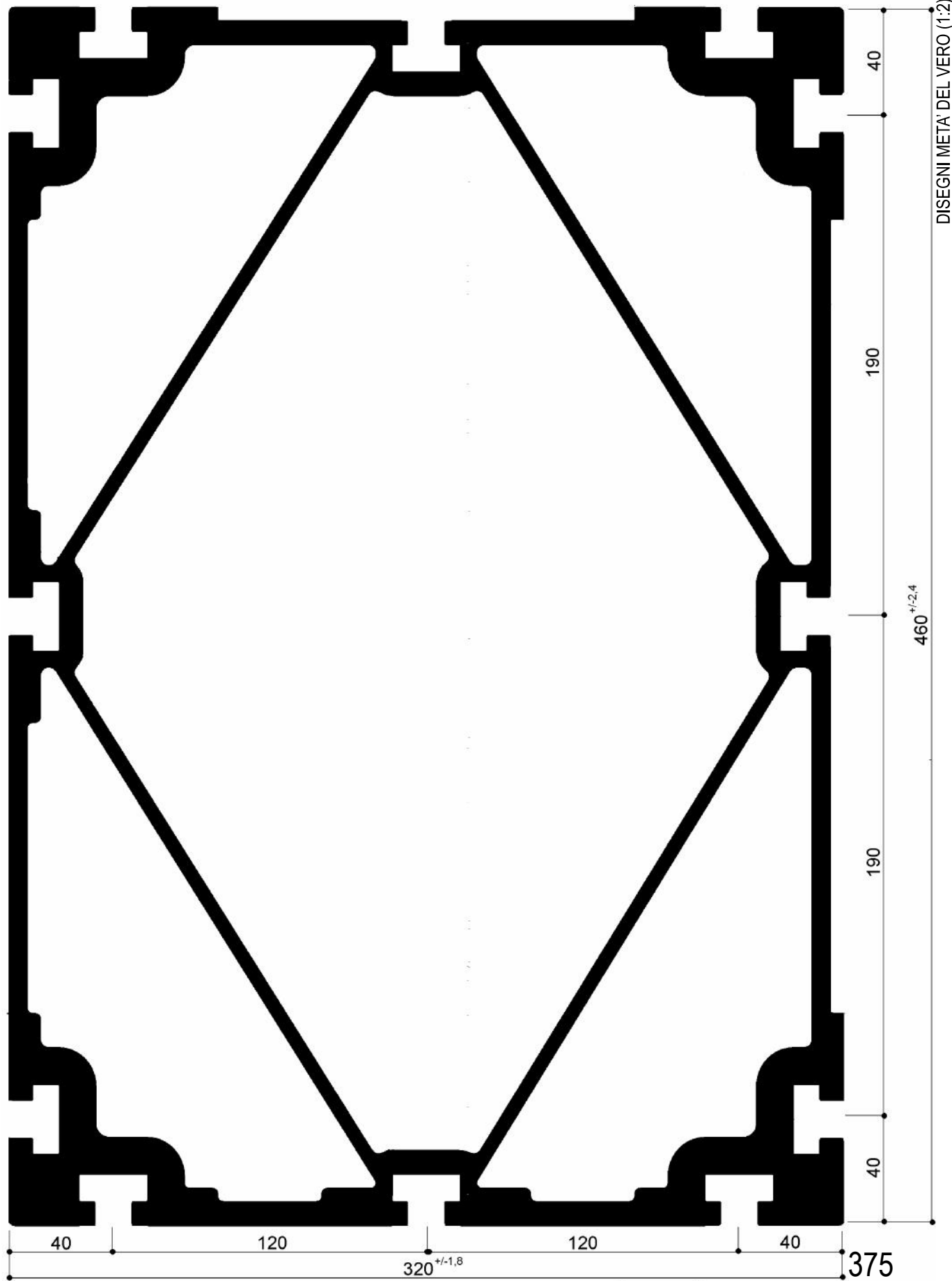

E' possibile fornire barre in lunghezza MASSIMA di 10 mt.
 AGGIORNAMENTO CONTINUO - ED. DEL 03-2023

-RIPRODUZIONE VIETATA-

Tubi per sistemi Pneumatici

Lega Alluminio 6060 T6 / 6063 T6

Caratteristiche meccaniche minime:

Rm = Mpa 245 Rp 0,2 = Mpa 200 A% = 8 HBW = 80

Anodizzazione:

- spessore dello strato di ossido: classe 20 μm +10/-4 (interno) +10/-8 (esterno)

- durezza dello strato di ossido: 420 HV25 +130/-30

Rugosità diametro interno:

- Ra radiale = 0,6 μm - Rmax radiale = 9 μm - Ra assiale = 0,4 μm

- * Ra radiale = 0,8 μm - * Rmax radiale = 10 μm - * Ra assiale = 0,5 μm

**NOTA: CARATTERISTICHE TECNICHE
PECULIARI PRODOTTO DI ALTA QUALITA'**

dopo accurata estrusione il profilo viene sottoposto a speciale
lavorazione di calibratura a freddo della camicia (parte interna)



I 4 fori di fissaggio sono
predisposti per la filettatura
metrica mediante la tradizionale
maschiatura ad asportazione
di truciolo

SERIE 80

DISEGNI META' DEL VERO (1:2)

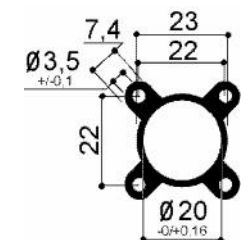

*PNM8020

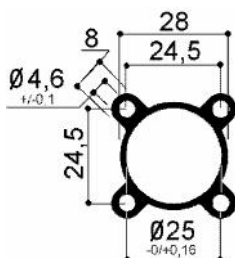

*PNM8025

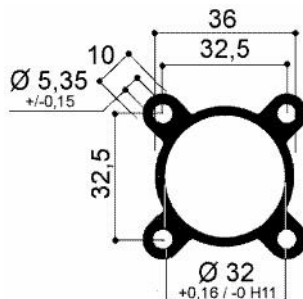

PNM8032

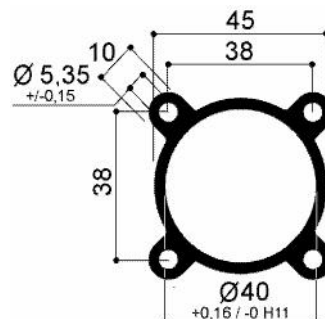

PNM8040

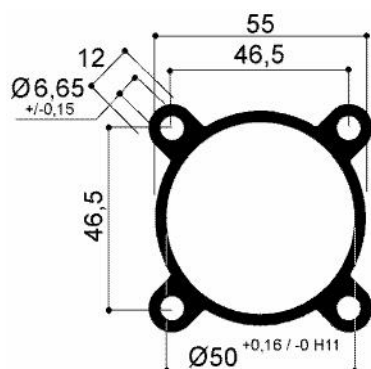

PNM8050

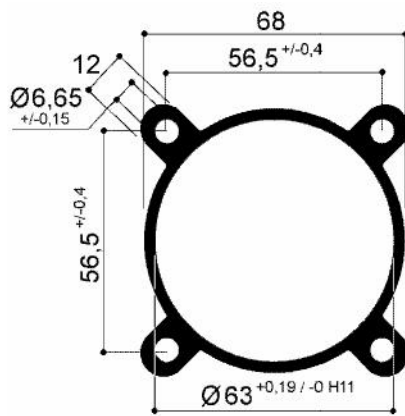

PNM8063

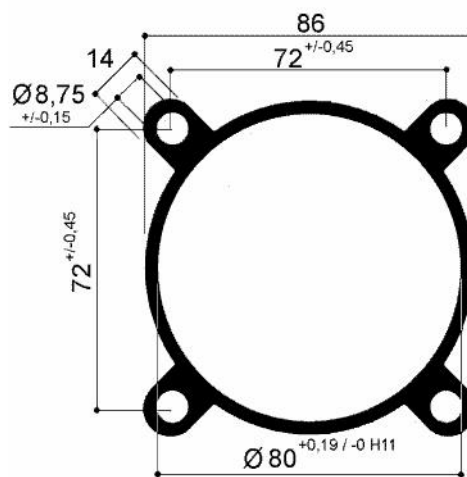

PNM8080

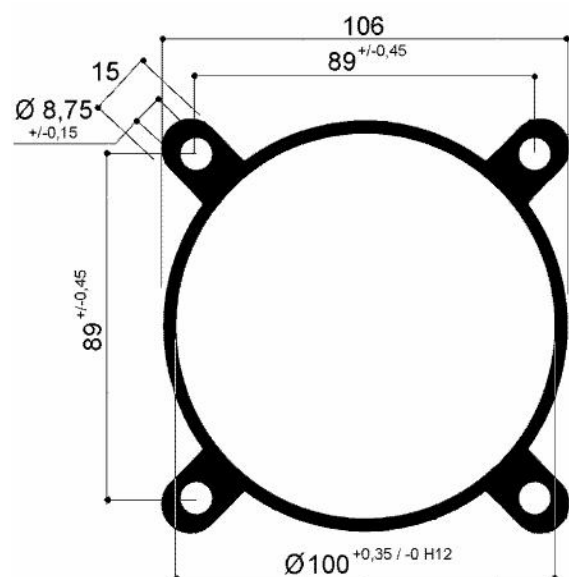

PNM80100

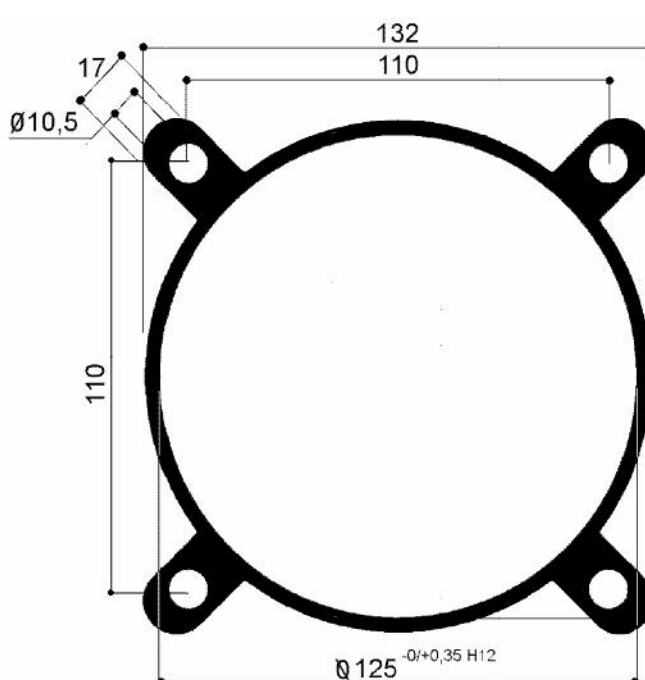

PNM80125

Via Newton, n.12

20016 Pero (Milano - Italy)

Tel. +39 02 3535955 r.a. Fax. +39 02 3539929

E-Mail: info@omar-alluminio.it

Cataloghi Online: www.omar-alluminio.it

www.omar-alluminio.com

PROFILATI ALLUMINIO A DISEGNO / STANDARD / SPECIALI / E PER:

ELETTRONICA / LED / FOTOVOLTAICO / AUTOMAZIONE ROBOTICA / PNEUMATICA / AUTOMOTIVE



Tubi per sistemi Pneumatici

Lega Alluminio 6063 T6

Caratteristiche meccaniche minime:

Rm = Mpa 245 Rp 0,2 = Mpa 200 A% = 8 HBW = 80

Anodizzazione:

- spessore dello strato di ossido: classe 20 $\mu\text{m} +10/-4$ (interno) $+10/-8$ (esterno)

- durezza dello strato di ossido: 420 HV25 +130/-30

Rugosità diametro interno:

-Ra radiale = 0,6 μm -Rmax radiale = 9 μm -Ra assiale = 0,4 μm

**NOTA: CARATTERISTICHE TECNICHE
PECULIARI PRODOTTO DI ALTA QUALITA'**

dopo accurata estrusione il profilo viene sottoposto a speciale lavorazione di calibratura a freddo della camicia (parte interna)



SERIE 90

ISO 15552

I 4 fori di fissaggio sono predisposti per la filettatura metrica mediante rullatura o per l'impiego di viti autofilettanti

DISEGNI META' DEL VERO (1:2)

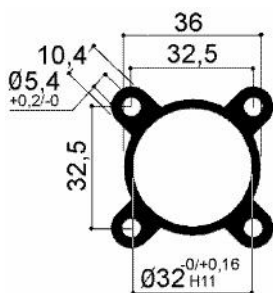

PNM9032

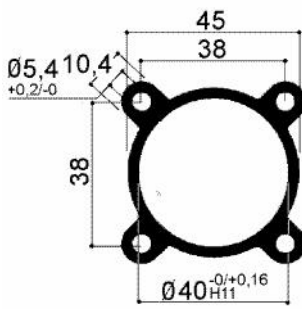

PNM9040

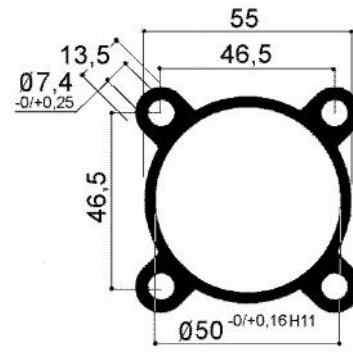

PNM9050

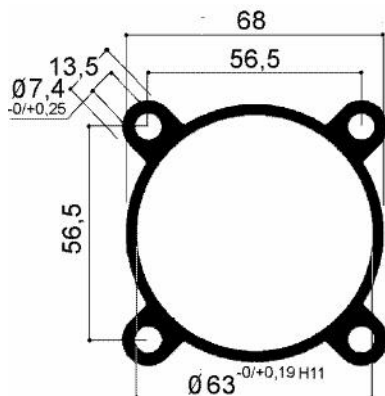

PNM9063

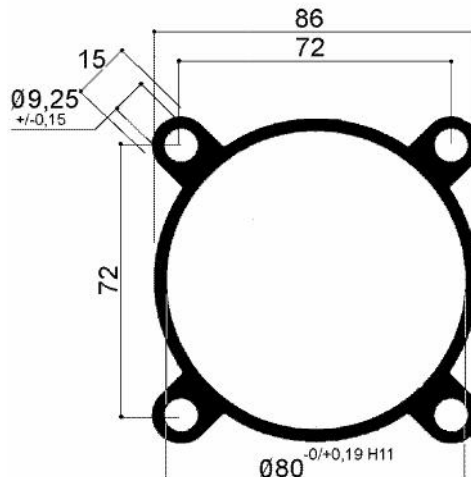

PNM9080

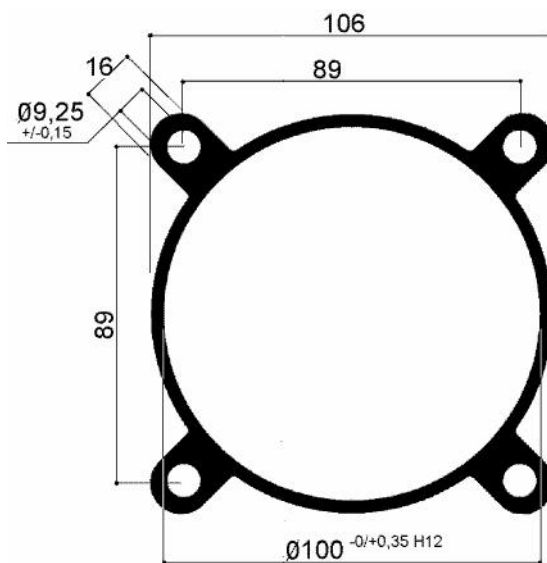

PNM90100

Tubi per sistemi Pneumatici

Lega Alluminio 6060 T6 / 6063 T6

Caratteristiche meccaniche minime:

Rm = Mpa 245 Rp 0,2 = Mpa 200 A% = 8 HBW = 80

Anodizzazione:

- spessore dello strato di ossido: classe 20 µm +10/-4 (interno) +10/-8 (esterno)

- durezza dello strato di ossido: 420 HV25 +130/-30

Rugosità diametro interno:

-Ra radiale = 0,6 µm -Rmax radiale = 9 µm -Ra assiale = 0,4 µm

* Ra radiale = 0,8 µm * Rmax radiale = 10 µm * Ra assiale = 0,5 µm

**NOTA: CARATTERISTICHE TECNICHE
PECULIARI PRODOTTO DI ALTA QUALITA'**

dopo accurata estrusione il profilo viene sottoposto a speciale lavorazione di calibratura a freddo della camicia (parte interna)



I 4 fori di fissaggio asolati sono predisposti per l'inserimento di tiranti in acciaio

SERIE 89

DISEGNI META' DEL VERO (1:2)

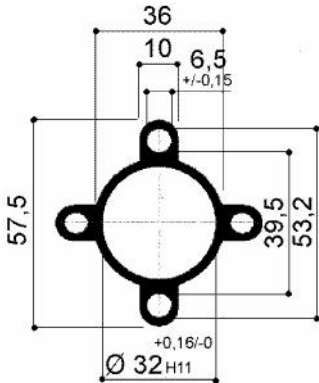

PNM8932

N.4 ASOLE A=6,5 B=6,85
PER SEDE TIRANTI

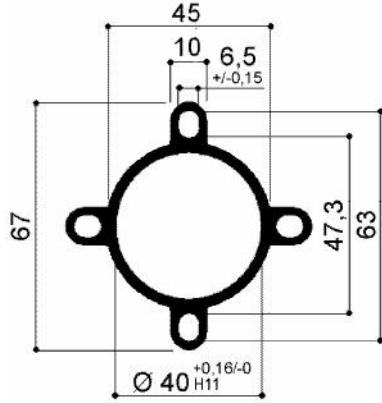

PNM8940

N.4 ASOLE A=6,5 B=7,85
PER SEDE TIRANTI

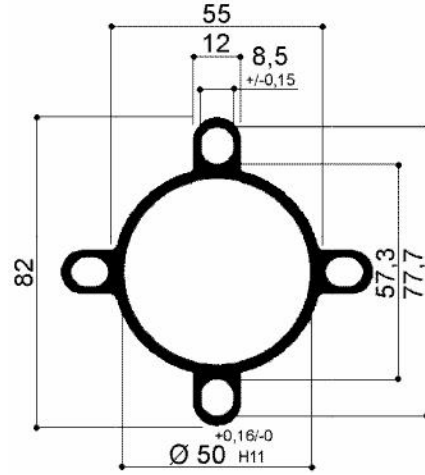

PNM8950

N.4 ASOLE A=8,5 B=10,20
PER SEDE TIRANTI

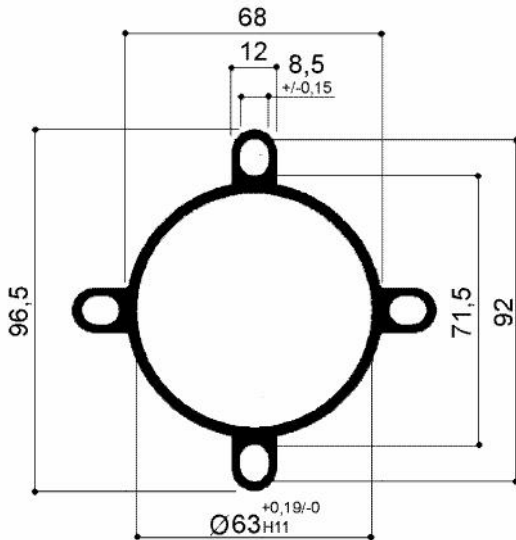

PNM8963

N.4 ASOLE A=8,5 B=10,25
PER SEDE TIRANTI

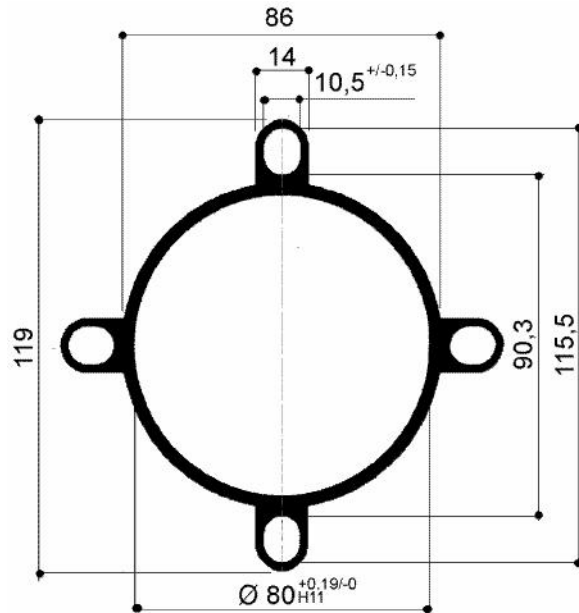

PNM8980

N.4 ASOLE DA A=10,5 B=12,60
PER SEDE TIRANTI

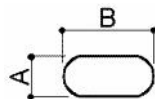

DETTAGLIO ASOLA PER SEDE TIRANTI

Via Newton, n.12

20016 Pero (Milano - Italy)

Tel. +39 02 3535955 r.a. Fax. +39 02 3539929

E-Mail: info@omar-alluminio.it

Cataloghi Online: www.omar-alluminio.it

www.omar-alluminio.com

PROFILATI ALLUMINIO A DISEGNO / STANDARD / SPECIALI / E PER:
ELETTRONICA / LED / FOTOVOLTAICO / AUTOMAZIONE ROBOTICA / PNEUMATICA / AUTOMOTIVE



Tubi per sistemi Pneumatici

Lega Alluminio 6060 T6 / 6063 T6

Caratteristiche meccaniche minime:

Rm = Mpa 245 Rp 0,2 = Mpa 200 A% = 8 HBW = 80

Anodizzazione:

- spessore dello strato di ossido: classe 20 μm +10/-4 (interno) +10/-8 (esterno)

- durezza dello strato di ossido: 420 HV25 +130/-30

Rugosità diametro interno:

-Ra radiale = 0,6 μm -Rmax radiale = 9 μm -Ra assiale = 0,4 μm

-* Ra radiale = 0,8 μm -* Rmax radiale = 10 μm -* Ra assiale = 0,5 μm

**NOTA: CARATTERISTICHE TECNICHE
PECULIARI PRODOTTO DI ALTA QUALITA'**

dopo accurata estrusione il profilo viene sottoposto a speciale lavorazione di calibratura a freddo della camicia (parte interna)



I 4 fori di fissaggio asolati sono predisposti per l'inserimento di tiranti in acciaio

SERIE 89

DISFGNI MFTA' DFL VERO (1:2)

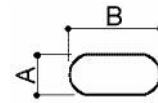
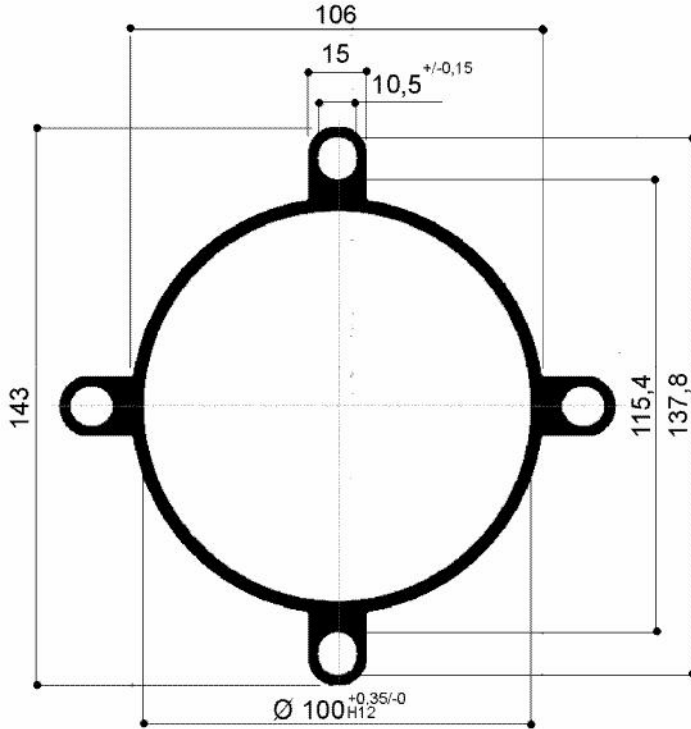

DETTAGLIO ASOLA
PER SEDE TIRANTI

PNM89100 N.4 ASOLE DA A=10,5 B=11,20
PER SEDE TIRANTI

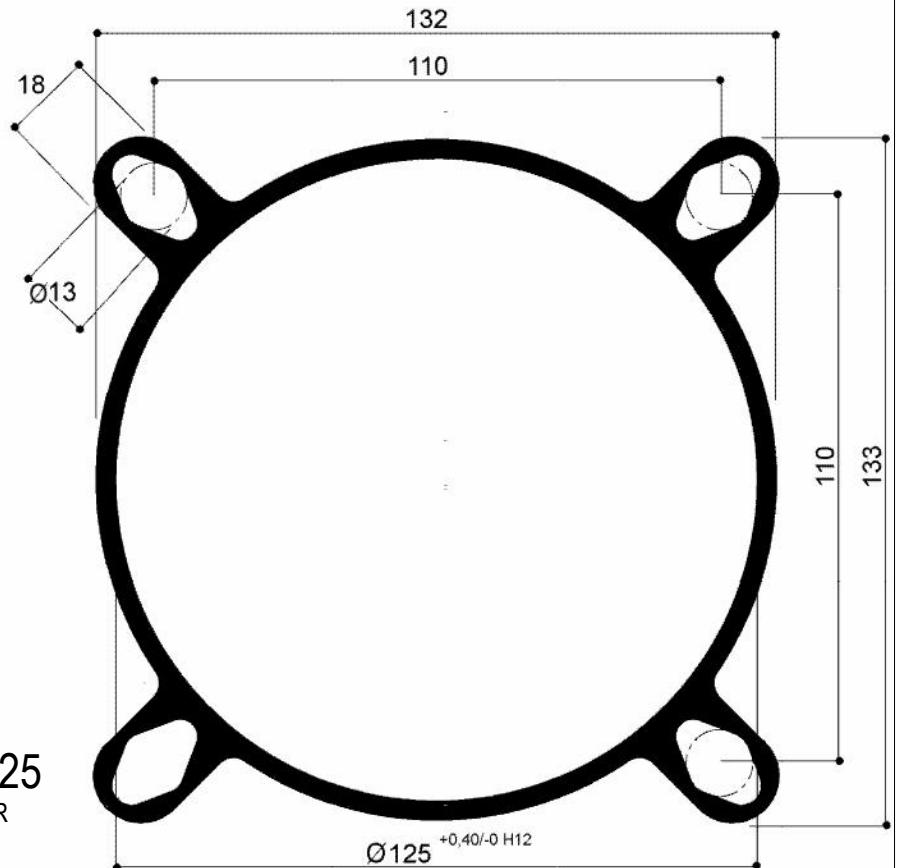

PNM89125
N.4 ASOLE PER
SEDE TIRANTI

Tubi per sistemi Pneumatici

Lega Alluminio 6060 T6 / 6063 T6

Caratteristiche meccaniche minime:

Rm = Mpa 245 Rp 0,2 = Mpa 200 A% = 8 HBW = 80

Anodizzazione:

- spessore dello strato di ossido: classe 20 µm +10/-4 (interno) +10/-8 (esterno)

- durezza dello strato di ossido: 420 HV25 +130/-30

Rugosità diametro interno:

-Ra radiale = 0,6 µm -Rmax radiale = 9 µm -Ra assiale = 0,4 µm

-* Ra radiale = 0,8 µm -* Rmax radiale = 10 µm -* Ra assiale = 0,5 µm

**NOTA: CARATTERISTICHE TECNICHE
PECULIARI PRODOTTO DI ALTA QUALITA'**

dopo accurata estrusione il profilo viene sottoposto a speciale
lavorazione di calibratura a freddo della camicia (parte interna)



I 4 fori di fissaggio asolati
sono predisposti per
l'inserimento di tiranti
in acciaio

SERIE 89

DISEGNI META' DEL VERO (1:2)- SCALE 1:2

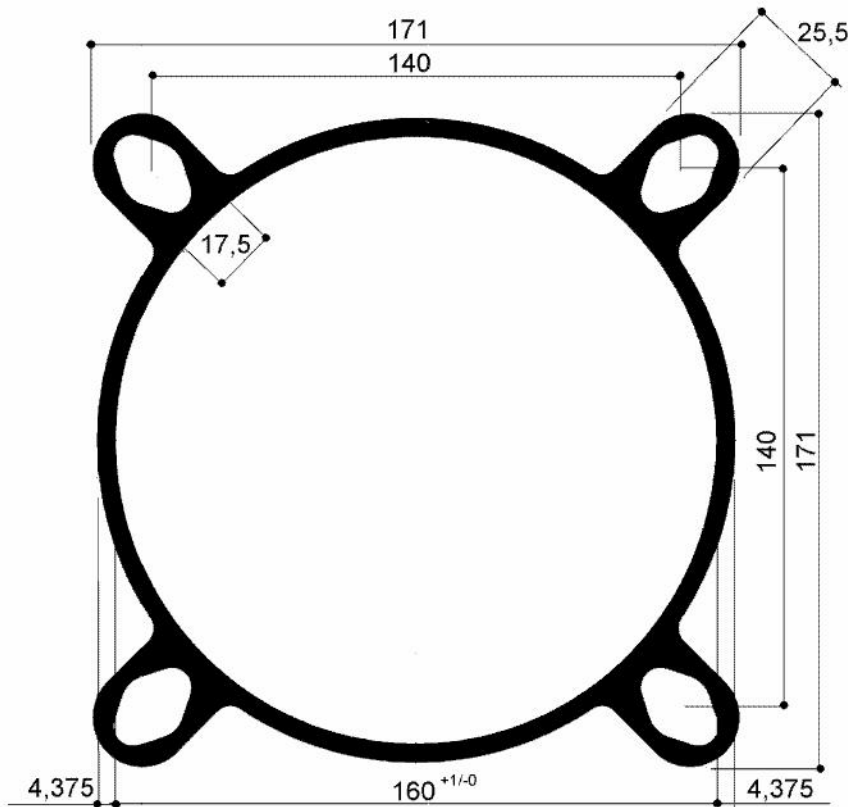

***PNM89160**
N.4 ASOLE PER
SEDE TIRANTI

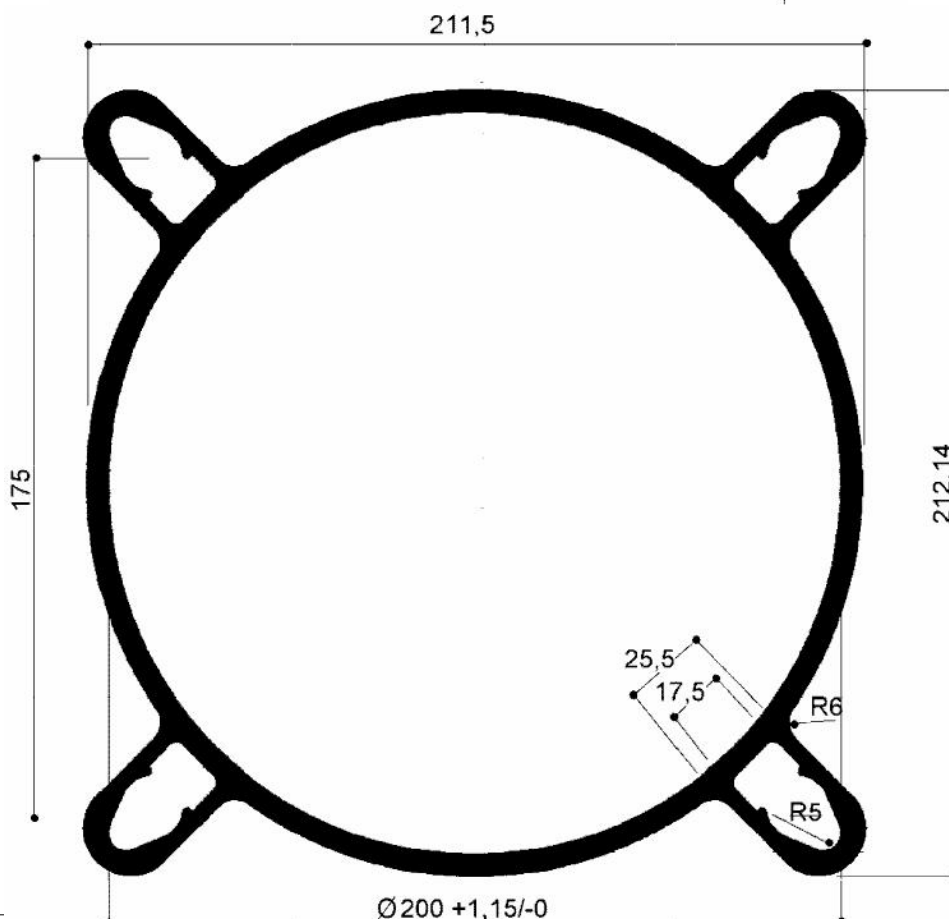

***PNM89200**
N.4 ASOLE PER
SEDE TIRANTI

Pag.83

Via Newton, n.12

20016 Pero (Milano - Italy)

Tel. +39 02 3535955 r.a. Fax. +39 02 3539929

E-Mail: info@omar-alluminio.it

Cataloghi Online: www.omar-alluminio.it

www.omar-alluminio.com

PROFILATI ALLUMINIO A DISEGNO / STANDARD / SPECIALI / E PER:

ELETTRONICA / LED / FOTOVOLTAICO / AUTOMAZIONE ROBOTICA / PNEUMATICA / AUTOMOTIVE



Tubi per sistemi Pneumatici

Lega Alluminio 6063 T6

Caratteristiche meccaniche minime:

Rm = Mpa 245 Rp 0,2 = Mpa 200 A% = 8 HBW = 80

Anodizzazione:

- spessore dello strato di ossido: classe 20 µm +10/-4 (interno) +10/-8 (esterno)

- durezza dello strato di ossido: 420 HV25 +130/-30

Rugosità diametro interno:

-Ra radiale = 0,6 µm -Rmax radiale = 9 µm -Ra assiale = 0,4 µm

**NOTA: CARATTERISTICHE TECNICHE
PECULIARI PRODOTTO DI ALTA QUALITA'**

dopo accurata estrusione il profilo viene sottoposto a speciale lavorazione di calibratura a freddo della camicia (parte interna)



Da ø32 a ø100 I fori di fissaggio sono predisposti per la filettatura metrica mediante rullatura o per l'impiego di viti autofilettanti

ø125 I fori di fissaggio sono predisposti per la filettatura metrica mediante la tradizionale maschiatura ad asportazione di truciolo

SERIE 99

ISO 15552 ex 6431

DISEGNI META' DEL VERO (1:2)

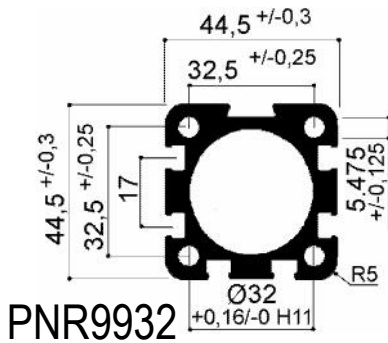

PNR9932

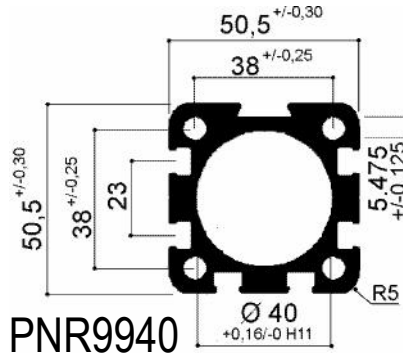

PNR9940

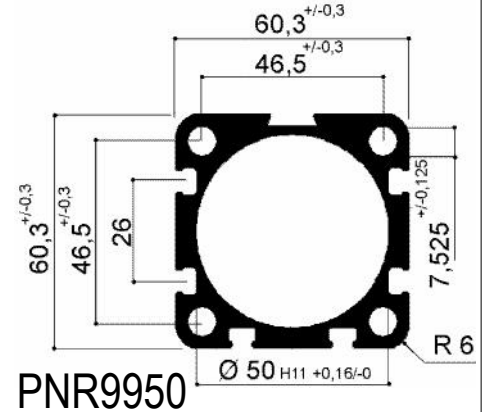

PNR9950

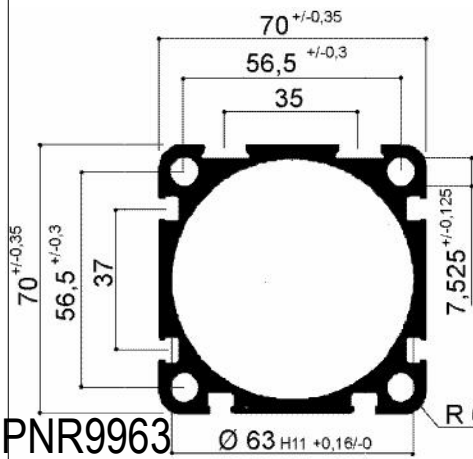

PNR9963

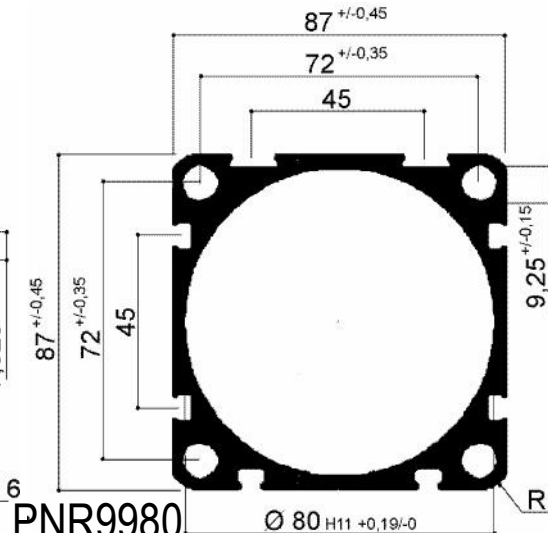

PNR9980

DETTAGLIO CAVE DEI PROFILI
SERIE 99

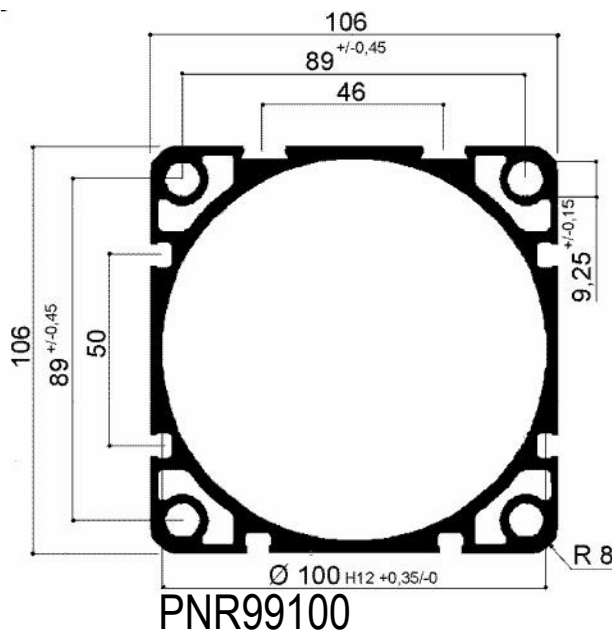
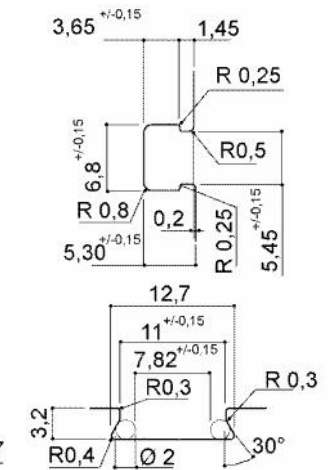

PNR99100

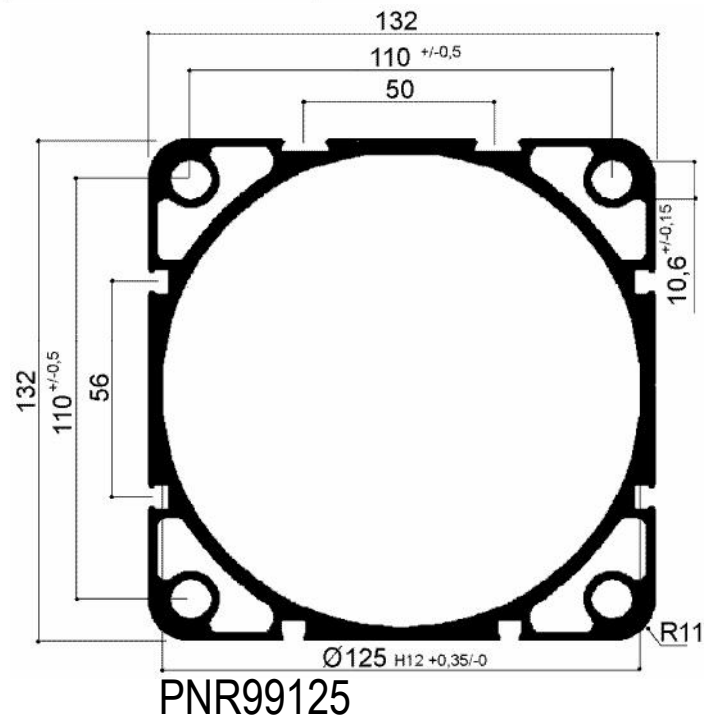

PNR99125

Tubi per sistemi Pneumatici

Lega Alluminio 6060 T6 / 6063 T6

Caratteristiche meccaniche minime:

Rm = Mpa 245 Rp 0,2 = Mpa 200 A% = 8 HBW = 80

Anodizzazione:

- spessore dello strato di ossido: classe 20 µm +10/-4 (interno) +10/-8 (esterno)

- durezza dello strato di ossido: 420 HV25 +130/-30

Rugosità diametro interno:

-Ra radiale = 0,6 µm -Rmax radiale = 9 µm -Ra assiale = 0,4 µm

-* Ra radiale = 0,8 µm -* Rmax radiale = 10 µm -* Ra assiale = 0,5 µm

**NOTA: CARATTERISTICHE TECNICHE
PECULIARI PRODOTTO DI ALTA QUALITA'**

dopo accurata estrusione il profilo viene sottoposto a speciale lavorazione di calibratura a freddo della camicia (parte interna)



I fori di fissaggio sono predisposti per la filettatura metrica mediante rullatura o per l'impiego di viti autofilettanti

SERIE 94

DISEGNI META' DEL VERO (1:2)

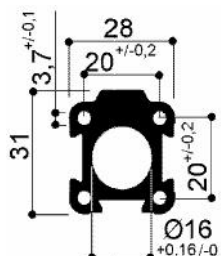

*PNP9416

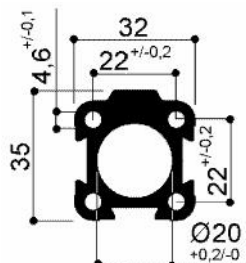

*PNP9420

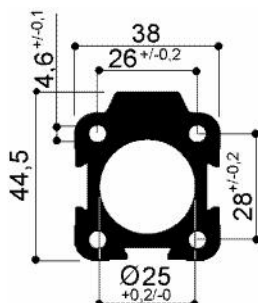

*PNP9425

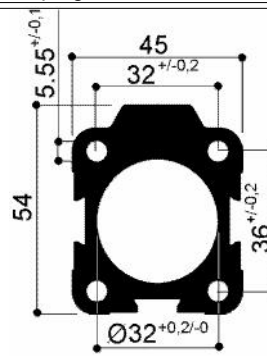

PNP9432

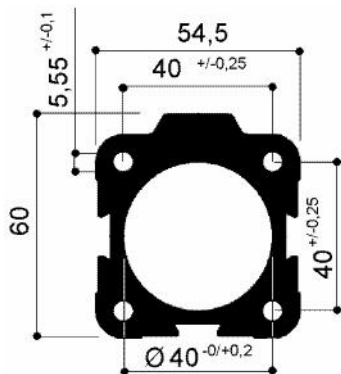

PNP9440

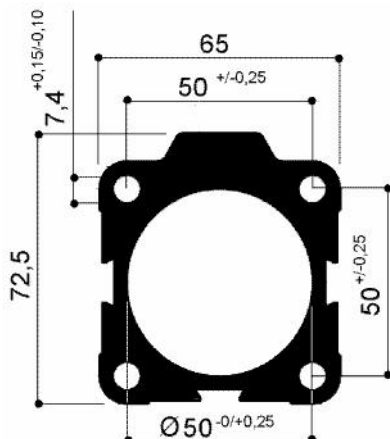

PNP9450

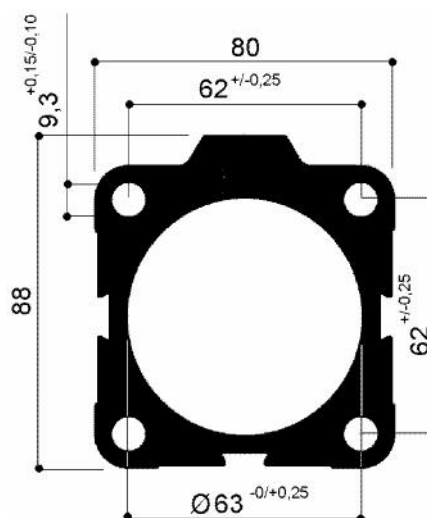

PNP9463

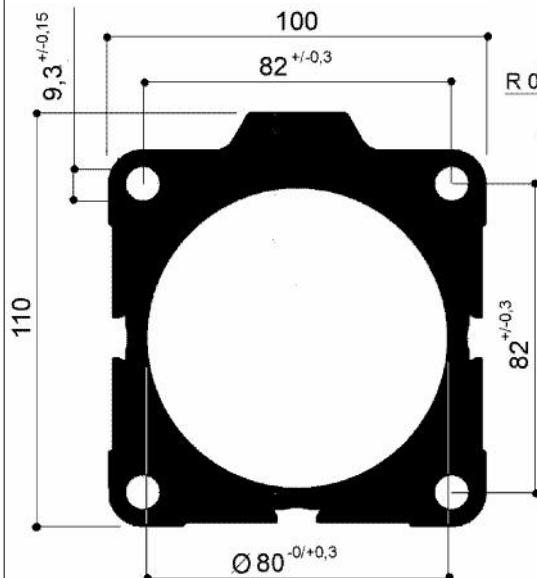

PNP9480

DETTAGLIO CAVE DEI
PROFILI SERIE 94

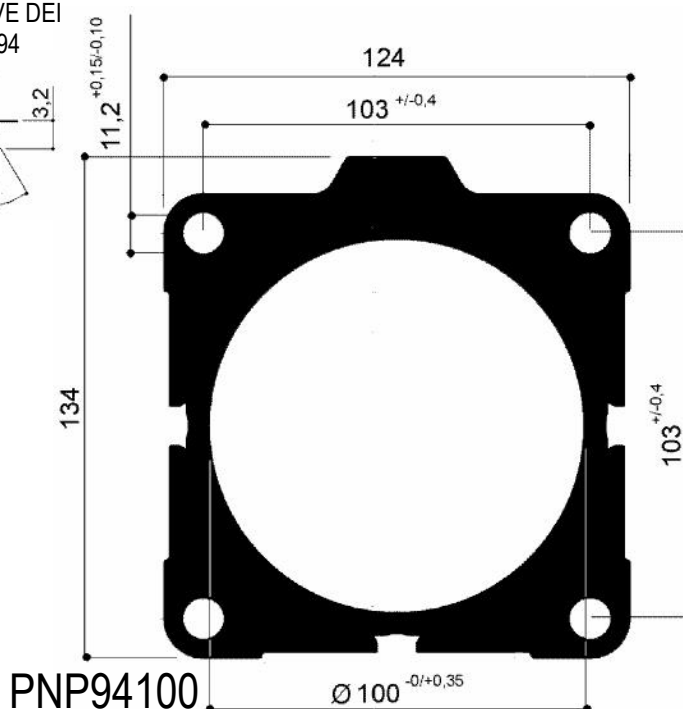
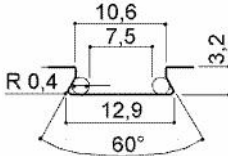

PNP94100

Tubi per sistemi Pneumatici

Lega Alluminio 6060 T6 / 6063 T6

Caratteristiche meccaniche minime:

Rm = Mpa 245 Rp 0,2 = Mpa 200 A% = 8 HBW = 80

Anodizzazione:

- spessore dello strato di ossido: classe 20 µm +10/-4 (interno) +10/-8 (esterno)

- durezza dello strato di ossido: 420 HV25 +130/-30

Rugosità diametro interno:

-Ra radiale = 0,6 µm -Rmax radiale = 9 µm -Ra assiale = 0,4 µm

-* Ra radiale = 0,8 µm -* Rmax radiale = 10 µm -* Ra assiale = 0,5 µm

**NOTA: CARATTERISTICHE TECNICHE
PECULIARI PRODOTTO DI ALTA QUALITA'**

dopo accurata estrusione il profilo viene sottoposto a speciale lavorazione di calibratura a freddo della camicia (parte interna)

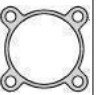

**Tubi tondi per pneumatica
(DIN EN 755-8 ex DIN59705)**

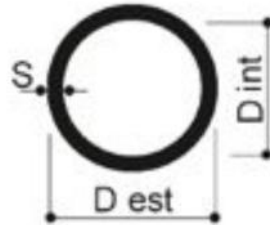

Codice	Diametro Interno (mm)	Toll. D. Interno	Diametro Esterno (mm)	Spessore
PNT1216	*12	H11	16	2
PNT1620	*16	H11	20	2
PNT2024	*20	H11	24	2
PNT2025	*20	H11	25	2,5
PNT2529	*25	H11	29	2
PNT2530	*25	H11	30	2,5
PNT3236	32	H11	36	2
PNT3238	32	+0,2/-0	38	3
PNT3540	35	+0,2/-0	40	2,5
PNT3640	36	+0,2/-0	40	2
PNT4044	40	H11	44	2
PNT4045	40	H11	45	2,5
PNT5054	50	H11	54	2
PNT5055	50	H11	55	2,5
PNT5057	50	H11	57	3,5
PNT5060	50	+0,25/-0	60	5
PNT5560	55	H11	60	2,5
PNT5660	56	H11	60	2
PNT6065	60	H11	65	2,5
PNT6367	63	H11	67	2
PNT6368	63	H11	68	2,5
PNT6570	65	H11	70	2,5
PNT7075	70	+0,30/-0	75	2,5
PNT7580	75	H11	80	2,5
PNT8085	80	H11	85	2,5
PNT8086	80	H11	86	3
PNT8590	85	H12	90	2,5
PNT9095	90	H12	95	2,5
PNT9097	90	H12	97	3,5
PNT95100	95	H12	100	2,5
PNT100106	100	H12	106	3
PNT100107	100	H12	107	3,5
PNT105110	105	H12	110	2,5
PNT125131	125	H12	131	3
PNT125132	125	H12	132	3,5
PNT150160	150	H13	160	5
PNT160167	160	H13	167	3,5
PNT160170	160	H13	170	5
PNT200210	200	+1	210	5

Tubi per sistemi Pneumatici

Lega Alluminio 6063 T6

Caratteristiche meccaniche minime:

Rm = Mpa 245 Rp 0,2 = Mpa 200 A% = 8 HBW = 80

Anodizzazione:

- spessore dello strato di ossido: classe 20 μm +10/-4 (interno) +10/-8 (esterno)

- durezza dello strato di ossido: 420 HV25 +130/-30

Rugosità' diametro interno:

-Ra radiale = 0,6 μm -Rmax radiale = 9 μm -Ra assiale = 0,4 μm

**NOTA: CARATTERISTICHE TECNICHE
PECULIARI PRODOTTO DI ALTA QUALITA'**

dopo accurata estrusione il profilo viene sottoposto a speciale lavorazione di calibratura a freddo della camicia (parte interna)



SERIE COMPATTO

UNITOP ISO 21287

I 4 fori di fissaggio sono predisposti per la filettatura metrica mediante rullatura o per l'impiego di viti autofilettanti

DISEGNI META' DEL VERO (1:2)

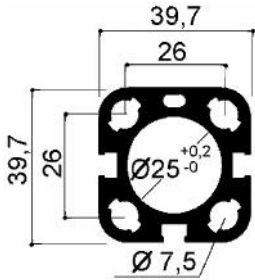

PNC25

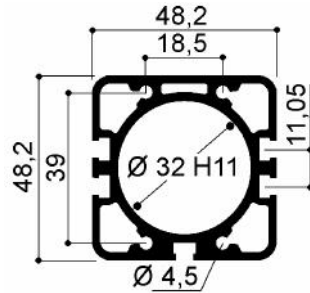

PNC32

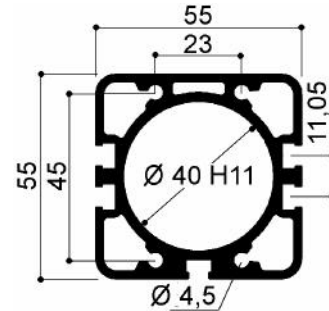

PNC40

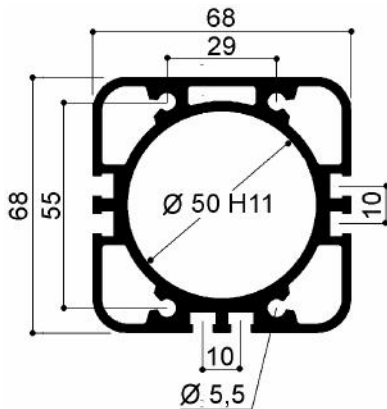

PNC50

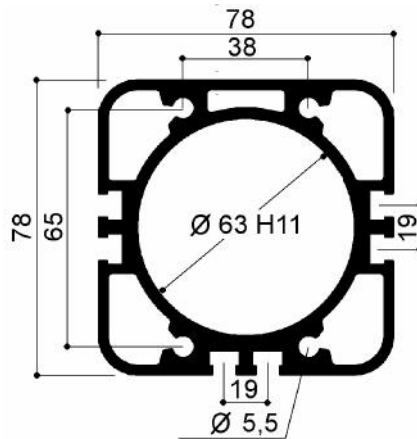

PNC63

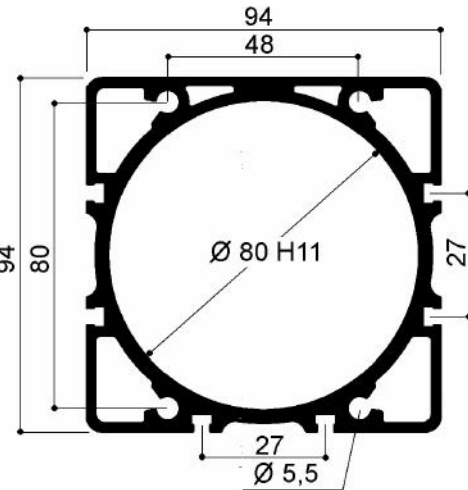

PNC80

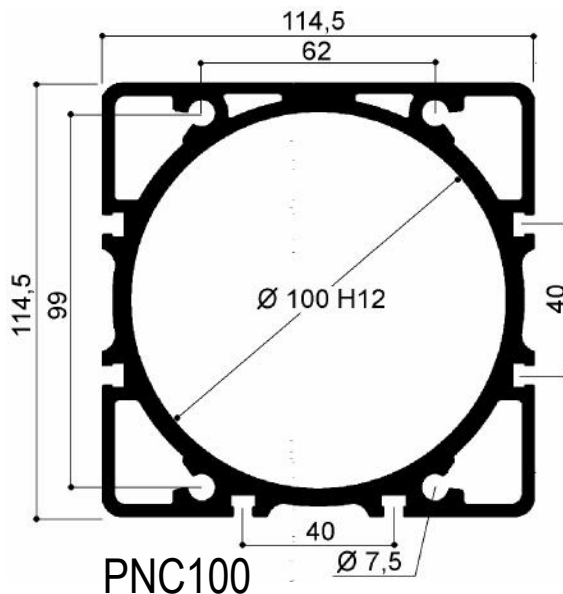

PNC100

DETTAGLIO CAVA

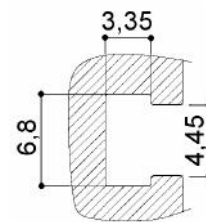

Via Newton, n.12

20016 Pero (Milano - Italy)

Tel. +39 02 3535955 r.a. Fax. +39 02 3539929

E-Mail: info@omar-alluminio.it

Cataloghi Online: www.omar-alluminio.it

www.omar-alluminio.com

PROFILATI ALLUMINIO A DISEGNO / STANDARD / SPECIALI / E PER:

ELETTRONICA / LED / FOTOVOLTAICO / AUTOMAZIONE ROBOTICA / PNEUMATICA / AUTOMOTIVE



Tubi per sistemi Pneumatici

Lega Alluminio 6063 T6

Caratteristiche meccaniche minime:

Rm = Mpa 245 Rp 0,2 = Mpa 200 A% = 8 HBW = 80

ESTRUSO TESTATA

PER CILINDRI SERIE COMPATTO

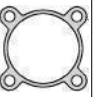

DISEGNI META' DEL VERO (1:2)

Via Newton, n.12
20016 Pero (Milano - Italy)
Tel. +39 02 3535955 r.a. Fax. +39 02 3539929
E-Mail: info@omar-alluminio.it

Cataloghi Online: www.omar-alluminio.it
www.omar-alluminio.com

PROFILATI ALLUMINIO A DISEGNO / STANDARD / SPECIALI / E PER:
ELETTRONICA / LED / FOTOVOLTAICO / AUTOMAZIONE ROBOTICA / PNEUMATICA / AUTOMOTIVE

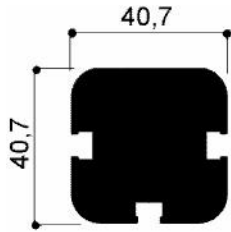

PNCT25

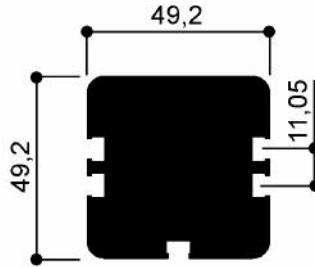

PNCT32

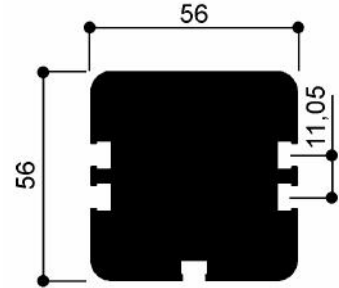

PNCT40

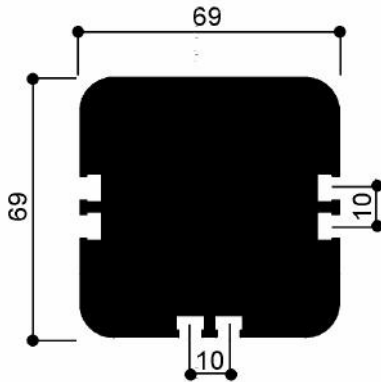

PNCT50

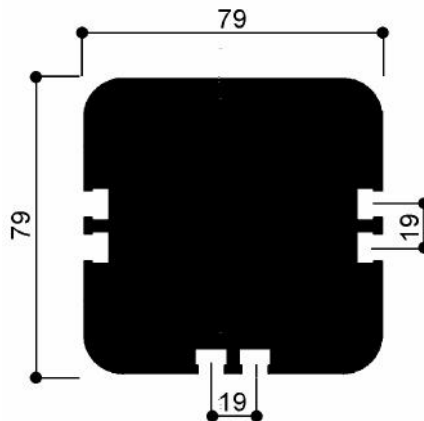

PNCT63

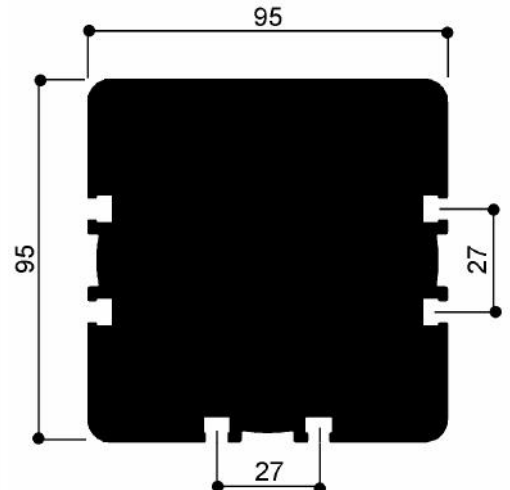

PNCT80

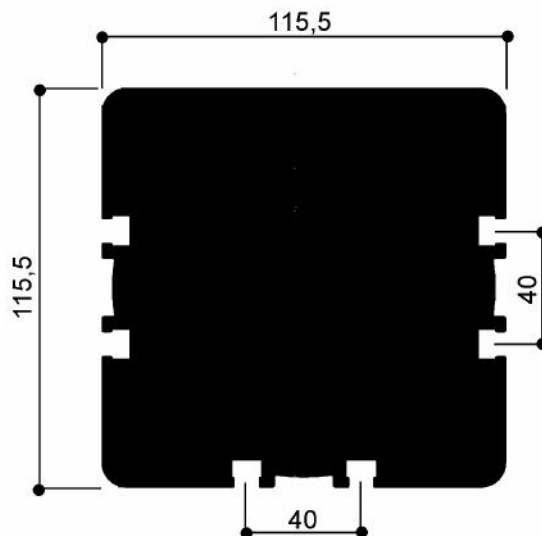

PNCT100

DETTAGLIO CAVA

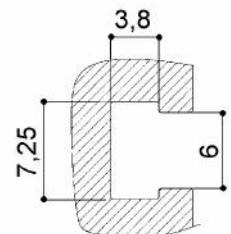

Tubi per sistemi Pneumatici

Legna Alluminio 6063 T6

Caratteristiche meccaniche minime:

Rm = Mpa 245 Rp 0,2 = Mpa 200 A% = 8 HBW = 80

Anodizzazione:

- spessore dello strato di ossido: classe 20 µm +10/-4 (interno) +10/-8 (esterno)

- durezza dello strato di ossido: 420 HV25 +130/-30

Rugosità' diametro interno:

-Ra radiale = 0,6 µm -Rmax radiale = 9 µm -Ra assiale = 0,4 µm

**NOTA: CARATTERISTICHE TECNICHE
PECULIARI PRODOTTO DI ALTA QUALITA'**

dopo accurata estrusione il profilo viene sottoposto a speciale lavorazione di calibratura a freddo della camicia (parte interna)



SERIE LIGHT ISO 15552 ex 6431

I fori di fissaggio sono predisposti per la filettatura metrica mediante rullatura

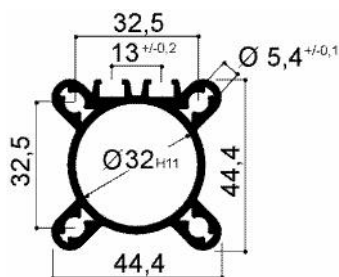

PNLG32

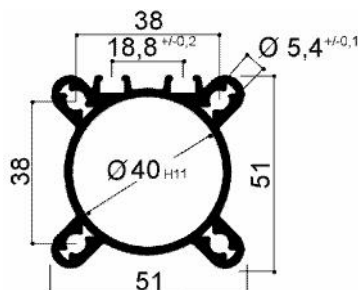

PNLG40

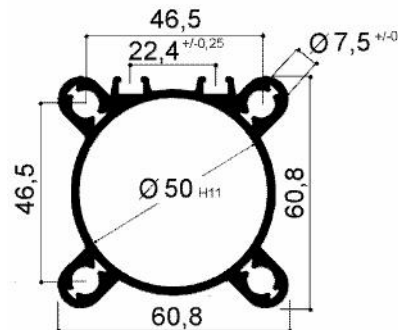

PNLG50

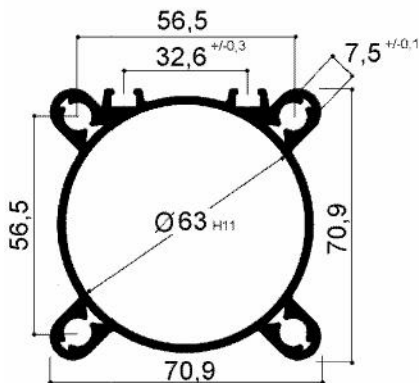

PNLG63

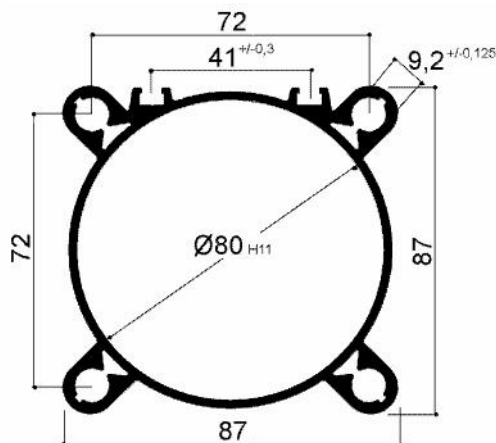

PNLG80

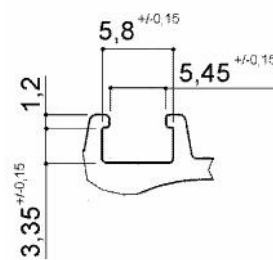

DETTAGLIO CAVA

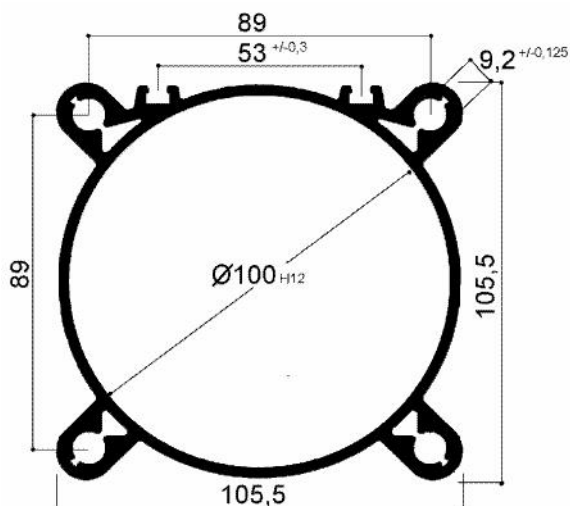

PNLG100

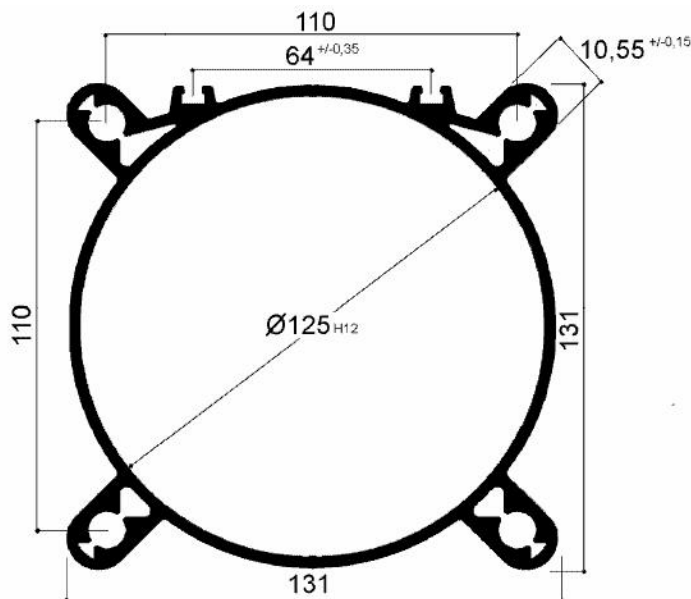

PNLG125

Via Newton, n.12

20016 Pero (Milano - Italy)

Tel. +39 02 3535955 r.a. Fax. +39 02 3539929

E-Mail: info@omar-alluminio.it

Cataloghi Online: www.omar-alluminio.it

www.omar-alluminio.com

PROFILATI ALLUMINIO A DISEGNO / STANDARD / SPECIALI / E PER:

ELETTRONICA / LED / FOTOVOLTAICO / AUTOMAZIONE ROBOTICA / PNEUMATICA / AUTOMOTIVE



Tubi per sistemi Pneumatici

Lega Alluminio 6063 T6

Caratteristiche meccaniche minime:

Rm = Mpa 245 Rp 0,2 = Mpa 200 A% = 8 HBW = 80

Anodizzazione:

- spessore dello strato di ossido: classe 20 µm +10/-4 (interno) +10/-8 (esterno)

- durezza dello strato di ossido: 420 HV25 +130/-30

Rugosità diametro interno:

-Ra radiale = 0,6 µm -Rmax radiale = 9 µm -Ra assiale = 0,4 µm

**NOTA: CARATTERISTICHE TECNICHE
PECULIARI PRODOTTO DI ALTA QUALITA'**

dopo accurata estrusione il profilo viene sottoposto a speciale lavorazione di calibratura a freddo della camicia (parte interna)



Via Newton, n.12
20016 Pero (Milano - Italy)
Tel. +39 02 3535955 r.a. Fax. +39 02 3539929
E. Mail: info@omar-alluminio.it

Cataloghi Online: www.omar-alluminio.it
www.omar-alluminio.com

PROFILATI ALLUMINIO A DISEGNO / STANDARD / SPECIALI / E PER:
ELETTRONICA / LED / FOTOVOLTAICO / AUTOMAZIONE ROBOTICA / PNEUMATICA / AUTOMOTIVE

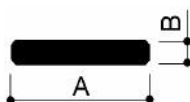
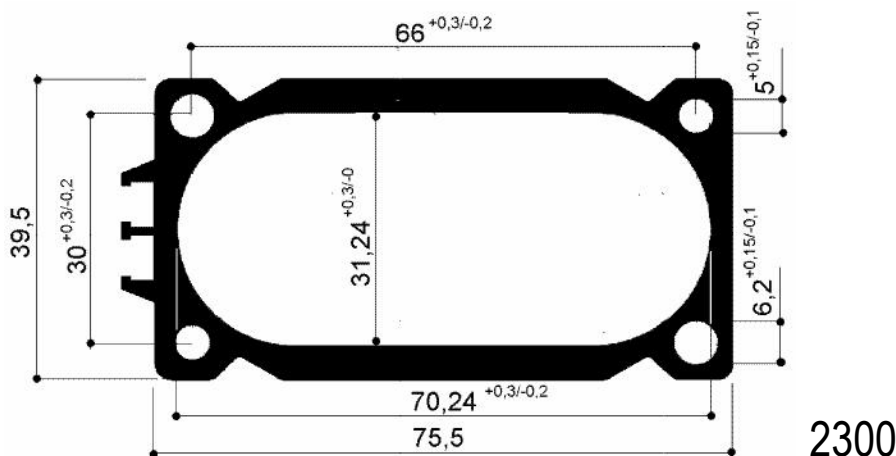

BARRE PIATTE TRAFILATE	DIMENSIONI Ax B	BARRE PIATTE TRAFILATE	DIMENSIONI Ax B
PTR2116	21x16	PTR4035	40x35
PTR2515	25x15	PTR4227	42x27
PTR2520	25x20	PTR4515	45x15
PTR2818	28x18	PTR4525	45x25
PTR3015	30x15	PTR4530	45x30
PTR3020	30x20	PTR4535	45x35
PTR3025	30x25	PTR5020	50x20
PTR3026	30x26	PTR5025	50x25
PTR3116	31x16	PTR5030	50x30
PTR3216	32x16	PTR5035	50x35
PTR3218	32x18	PTR5040	50x40
PTR3222	32x22	PTR5230	52x30
PTR3416	34x16	PTR5535	55x35
PTR3515	35x15	PTR6020	60x20
PTR3520	35x20	PTR6025	60x25
PTR3525	35x25	PTR6030	60x30
PTR3618	36x18	PTR6035	60x35
PTR3832	38x32	PTR6040	60x40
PTR4015	40x15	PTR6050	60x50
PTR4020	40x20	PTR6535	65x35
PTR4022	40x22	PTR6545	65x45
PTR4025	40x25	PTR7030	70x30
PTR4030	40x30	PTR7035	70x35
PTR4035	40x35	PTR7040	70x40

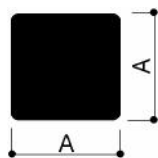

BARRE QUADRE TRAFILATE	DIMENSIONI Ax A	BARRE QUADRE TRAFILATE	DIMENSIONI Ax A
BQTR15	15x15	BQTR35	35x35
BQTR18	18x18	BQTR40	40x40
BQTR20	20x20	BQTR42	42x42
BQTR22	22x22	BQTR45	45x45
BQTR24	24x24	BQTR46	46x46
BQTR25	25x25	BQTR50	50x50
BQTR26	26x26	BQTR52	52x52
BQTR30	30x30	BQTR55	55x55
BQTR32	32x32	BQTR60	60x60
BQTR34	34x34		

Profilati in alluminio per impianti Fotovoltaici/Calorici



Gamma completa per:

-Profili in alluminio grezzo / ossidazione naturale in barre da mt.6

-Accessori adatti alla realizzazione di strutture

DISEGNI META' DEL VERO (1:2)- SCALE 1:2

DISEGNI AL VERO (1:1)- SCALE 1:1

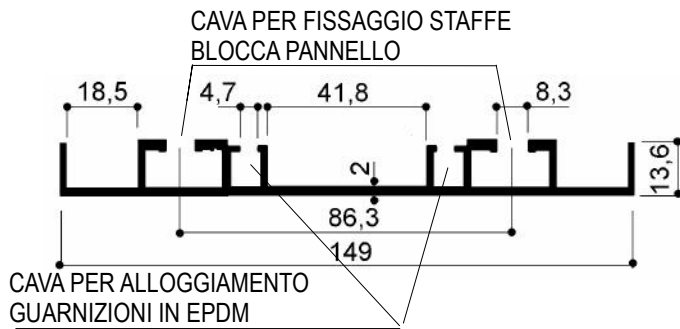

738

Cod.FM738:

Peso teorico Kg/mt: 1,429

Momento d'inerzia: Jx: 1,620 cm⁴

Jy: 128,818 cm⁴

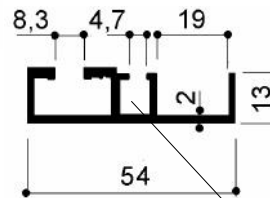

337

Cod.FM337:

Peso teorico Kg/mt: 0,540

Momento d'inerzia: Jx: 0,513 cm⁴

Jy: 5,613 cm⁴

PROFILO BLOCCA
PANNELLO CENTRALE
COD.705,758,793,

PANNELLI SOLARI

PROFILO BLOCCA
PANNELLO LATERALE
COD.706,707,781,
782,783,794

GUARNIZIONI IN
MATERIALE PLASTICO
COD.EPDM738

TRAVE TETTO

PROFILO STRUTTURALE
TIPO 787,796 ETC...

PROFILO ART.738



GUARNIZIONI IN
MATERIALE PLASTICO EPDM NERO
COD.EPDM738 ROTOLI DA MT.150



Cataloghi Online: www.omar-alluminio.it

www.omar-alluminio.com

PROFILATI ALLUMINIO A DISEGNO / STANDARD / SPECIALI / E PER

ELETTRONICA / LED / FOTOVOLTAICO / AUTOMAZIONE ROBOTICA / PNEUMATICA / AUTOMOTIVE

Via Newton, n.12

20016 Pero (Milano - Italy)

Tel. +39 02 3535955 r.a. Fax. +39 02 3539929

E.Mail: info@omar-alluminio.it



Profilati in alluminio per impianti Fotovoltaici/Calorici

Gamma completa per:

- Profili in alluminio grezzo / ossidazione naturale in barre da mt.6
- Accessori adatti alla realizzazione di strutture



DISEGNI AL VERO (1:1)- SCALE 1:1

CAVA PER L'EVENTUALE APPLICAZIONE DELLA GUARNIZIONE
COD. EPDM712

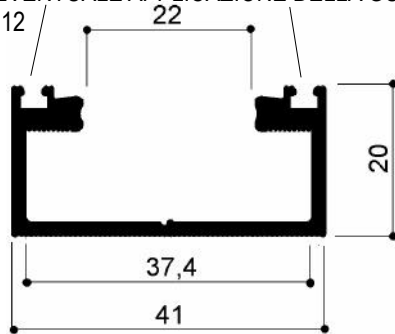

338

Cod.FM338:
Peso teorico Kg/mt: 0,500
Momento d'inerzia: Jx: 0,909 cm⁴
Jy: 4,581 cm⁴

CAVA PER L'EVENTUALE APPLICAZIONE DELLA GUARNIZIONE
COD. EPDM712

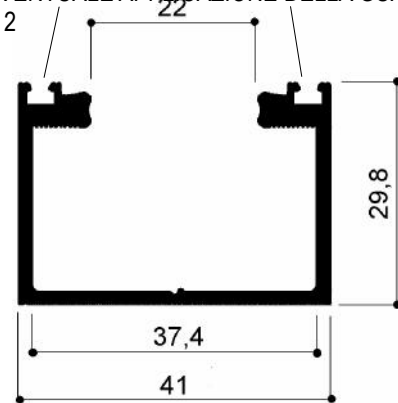

339

Cod.FM339:
Peso teorico Kg/mt: 0,610
Momento d'inerzia: Jx: 2,675 cm⁴
Jy: 6,033 cm⁴

CAVA PER L'EVENTUALE APPLICAZIONE DELLA GUARNIZIONE
COD. EPDM712

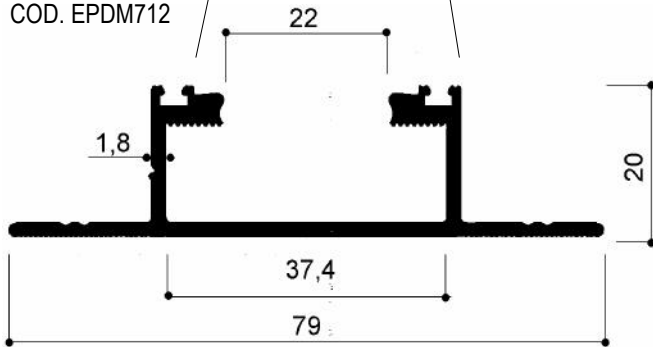

340

Cod.FM340:
Peso teorico Kg/mt: 0,680
Momento d'inerzia: Jx: 1,259 cm⁴
Jy: 10,432 cm⁴

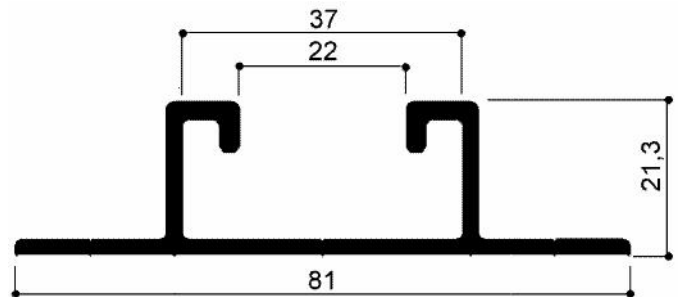

700

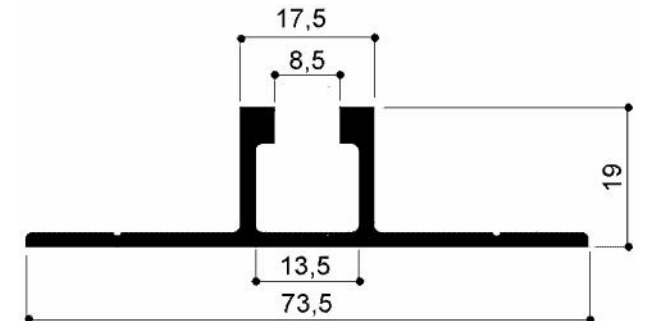

380

Cod.FM380:
Peso teorico Kg/mt: 0,647
Momento d'inerzia: Jx: 9,435 cm⁴
Jy: 7,000 cm⁴

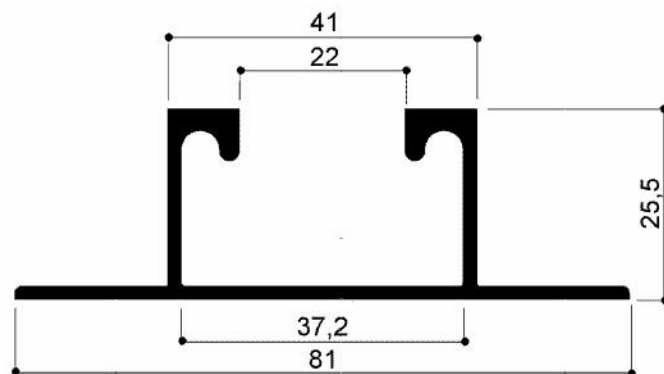

381

Cod.FM380:
Peso teorico Kg/mt: 0,647
Momento d'inerzia: Jx: 9,435 cm⁴
Jy: 7,000 cm⁴

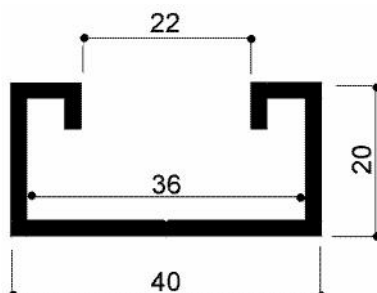

386

Cod.FM386:
Peso teorico Kg/mt: 0,529
Momento d'inerzia: Jx: 1,093 cm⁴
Jy: 4,499 cm⁴

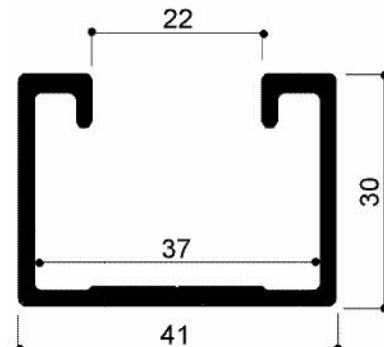

387

Cod.FM387:
Peso teorico Kg/mt: 0,701
Momento d'inerzia: Jx: 3,332 cm⁴
Jy: 6,538 cm⁴

Via Newton, n.12

20016 Pero (Milano - Italy)

Tel.+39 02 3535955 r.a. Fax.+39 02 3539929

E.Mail: info@omar-alluminio.it

Cataloghi Online: www.omar-alluminio.it

www.omar-alluminio.com

PROFILATI ALLUMINIO A DISEGNO / STANDARD / SPECIALI / E PER

ELETTRONICA / LED / FOTOVOLTAICO / AUTOMAZIONE ROBOTICA / PNEUMATICA / AUTOMOTIVE



Profilati in alluminio per impianti Fotovoltaici/Calorici



Gamma completa per:

-Profili in alluminio grezzo / ossidazione naturale in barre da mt.6

-Accessori adatti alla realizzazione di strutture

Omar srl, siamo specializzati nella fornitura, commercio all'ingrosso, e vendita di profili in alluminio anche anodizzato e accessori per la realizzazione di sistemi, impianti fotovoltaici. Profili per sottostrutture di impianti fotovoltaici e relativi sistemi di ancoraggio dei moduli fotovoltaici. Gamma completa di Staffaggio in alluminio per modulo fotovoltaico. Profili in alluminio, porta-modulo per impianti solari e fotovoltaici. Disponibili tutti gli accessori per l'ancoraggio ed il fissaggio dei pannelli fotovoltaici : morsetti finali ed intermedi, omega in alluminio per pannelli fotovoltaici

DISEGNI AL VERO (1:1)- SCALE 1:1

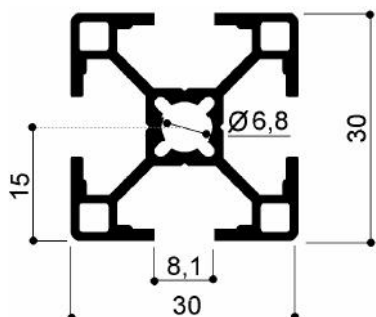

797

Cod.FM797:
Peso teorico Kg/mt: 0,637
Momento d'inerzia: Jx: 2,275 cm⁴
Jy: 2,274 cm⁴

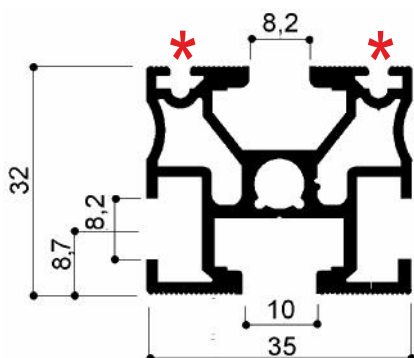

335

Cod.FM335:
Peso teorico Kg/mt: 0,827

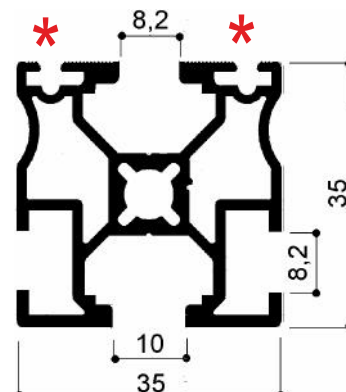

333

Cod.FM797:
Peso teorico Kg/mt: 0,850

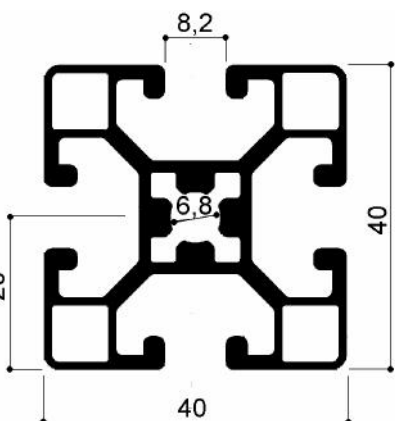

359

Cod.FM359:
Peso teorico Kg/mt: 1,210
Momento d'inerzia: Jx: 6,480 cm⁴
Jy: 6,480 cm⁴

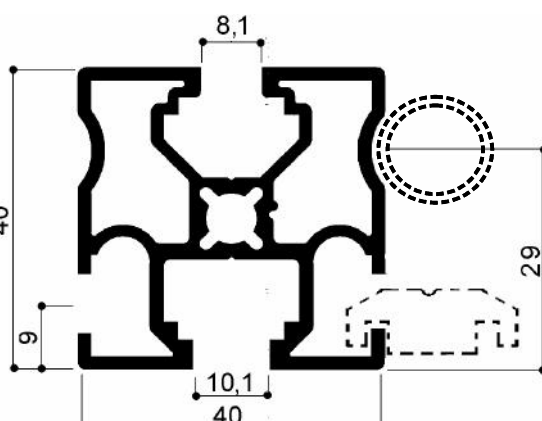

787

Cod.FM787:
Peso teorico Kg/mt: 1,210
Momento d'inerzia: Jx: 7,340 cm⁴
Jy: 7,007 cm⁴

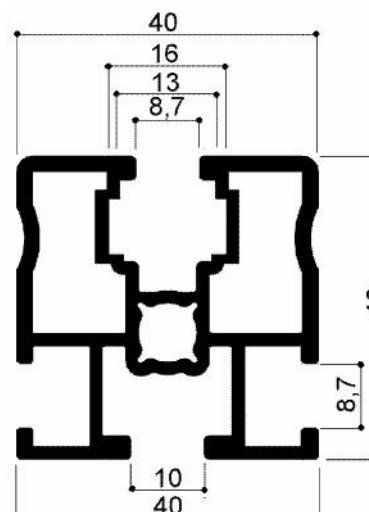

332

Cod.FM332:
Peso teorico Kg/mt: 1,480
Momento d'inerzia: Jx: 6,900 cm⁴
Jy: 7,000 cm⁴

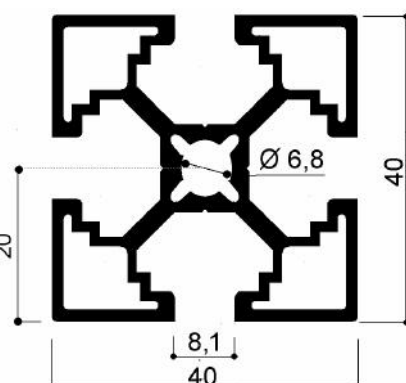

796

Cod.FM796
Peso teorico Kg/mt: 1,257
Momento d'inerzia: Jx: 7,380 cm⁴
Jy: 7,380 cm⁴

752

Cod.FM752:
Peso teorico Kg/mt: 1,787
Momento d'inerzia: Jx: 12,40 cm⁴
Jy: 12,40 cm⁴

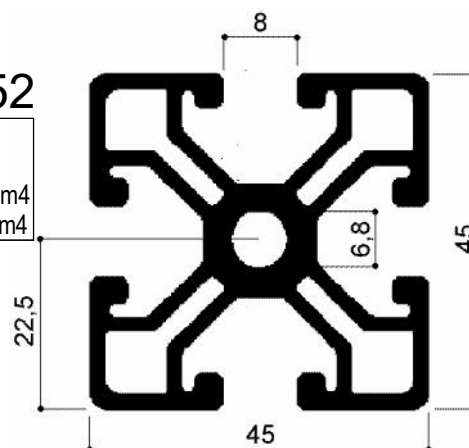

E' possibile fornire barre in lunghezza MASSIMA di 8 mt. grezzo e anodizzato

Cataloghi Online: www.omar-alluminio.it

www.omar-alluminio.com

PROFILATI ALLUMINIO A DISEGNO / STANDARD / SPECIALI / E PER

ELETTRONICA / LED / FOTOVOLTAICO / AUTOMAZIONE ROBOTICA / PNEUMATICA / AUTOMOTIVE

Via Newton, n.12

20016 Pero (Milano - Italy)

Tel. +39 02 3535955 r.a. Fax. +39 02 3539929

E.Mail: info@omar-alluminio.it



Profilati in alluminio per impianti Fotovoltaici/Calorici

Gamma completa per:

- Profili in alluminio grezzo / ossidazione naturale in barre da mt.6
- Accessori adatti alla realizzazione di strutture



Via Newton, n.12
20016 Pero (Milano - Italy)
Tel.+39 02 3535955 r.a. Fax.+39 02 3539929
E.Mail: info@omar-alluminio.it

Cataloghi Online: www.omar-alluminio.it
www.omar-alluminio.com

PROFILATI ALLUMINIO A DISEGNO / STANDARD / SPECIALI / E PER
ELETTRONICA / LED / FOTOVOLTAICO / AUTOMAZIONE ROBOTICA / PNEUMATICA / AUTOMOTIVE

DISEGNI AL VERO (1:1)- SCALE 1:1

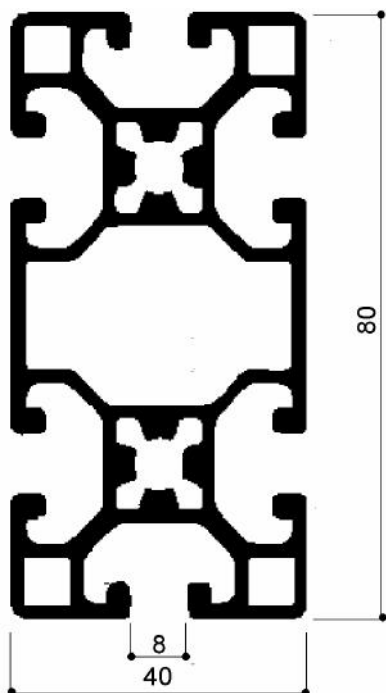

779 Cod.FM779
Peso teorico Kg/mt: 2,432
Momento d'inerzia: Jx: 15,151 cm⁴
Jy: 59,684 cm⁴

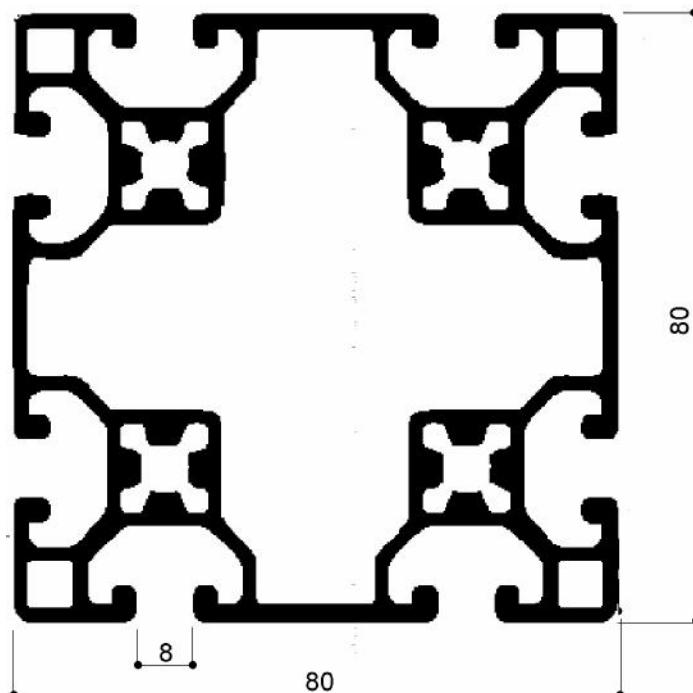

780 Cod.FM780:
Peso teorico Kg/mt: 3,846
Momento d'inerzia: Jx: 103,553 cm⁴
Jy: 103,553 cm⁴

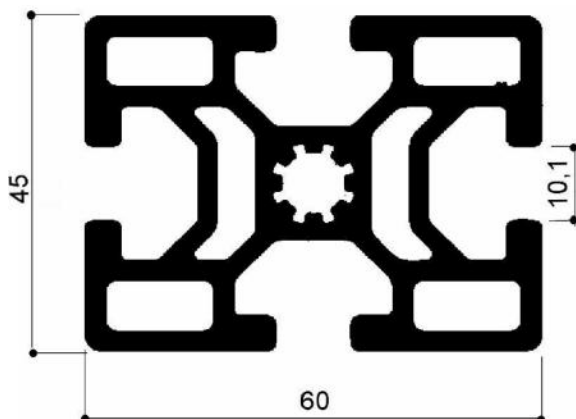

367
Cod.FM367:
Peso teorico Kg/mt: 2,835
Momento d'inerzia: Jx: 21,46 cm⁴
Jy: 35,79 cm⁴

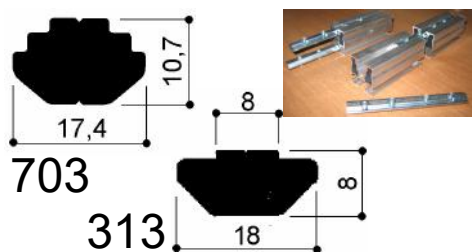
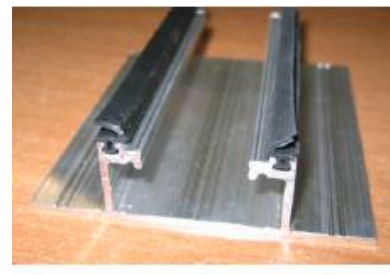

703

313



PROFILO DI GUARNIZIONE
IN MATERIALE PLASTICO
(EPDM). ROTOLI DA MT 300

EPDM712

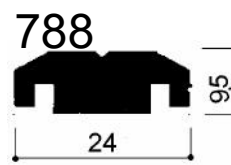

788

DISEGNI META' DEL VERO (1:2)- SCALE 1:2

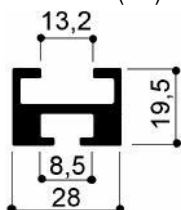

2243*

*PROFILO RISERVATO

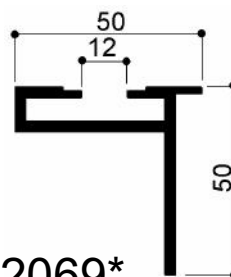

2069*

Profilo porta catena per
spazzole pulisci pannelli



Profilati in alluminio per impianti Fotovoltaici/Calorici

Gamma completa per:

- Profili in alluminio grezzo / ossidazione naturale in barre da mt.6
- Accessori adatti alla realizzazione di strutture

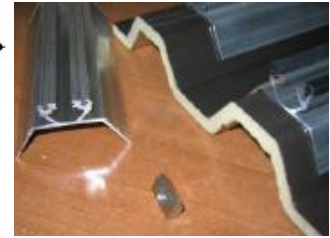
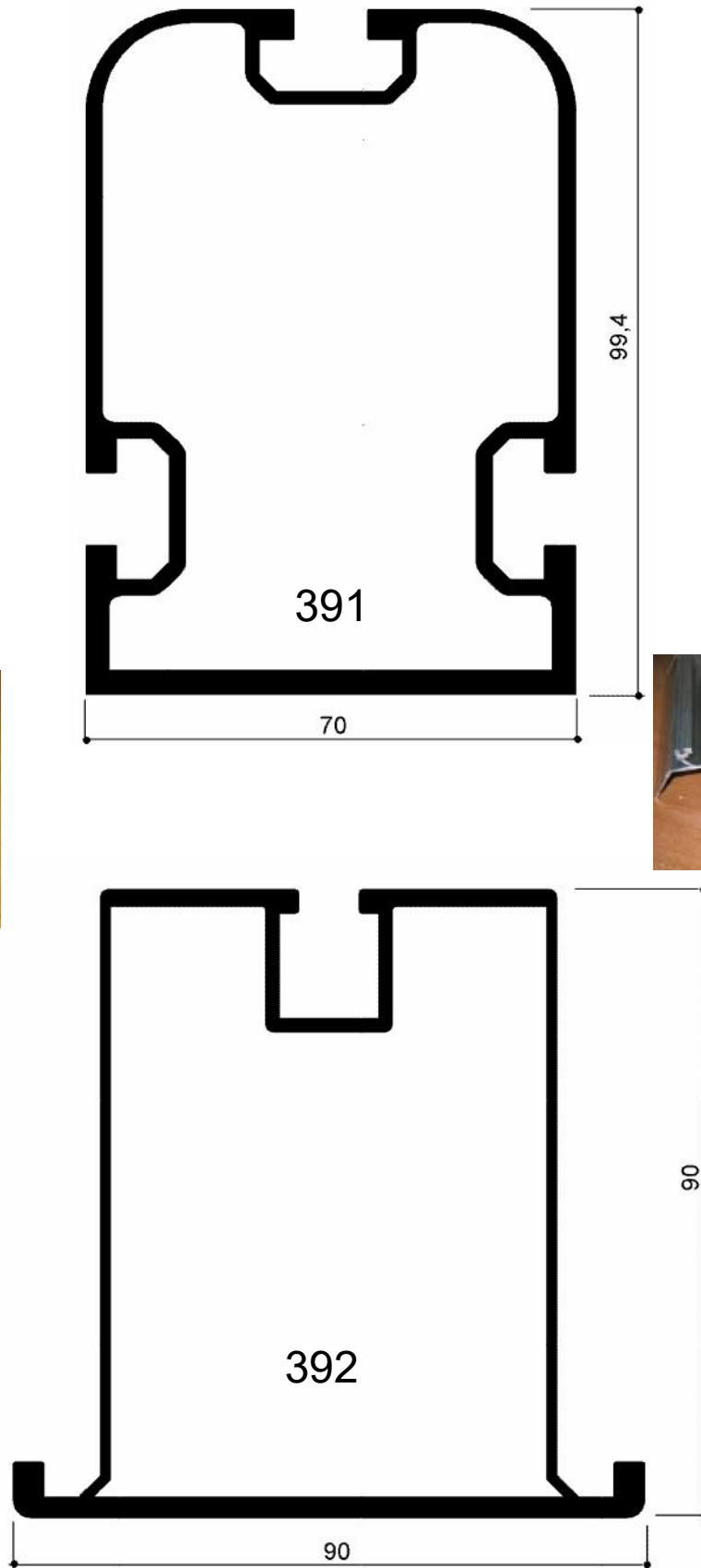
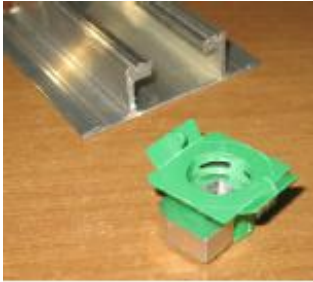

E' possibile fornire barre in lunghezza MASSIMA di 9 mt. grezzo e anodizzato

Cataloghi Online: www.omar-alluminio.it

www.omar-alluminio.com

PROFILATI ALLUMINIO A DISEGNO / STANDARD / SPECIALI / E PER

ELETTRONICA / LED / FOTOVOLTAICO / AUTOMAZIONE ROBOTICA / PNEUMATICA / AUTOMOTIVE

Via Newton, n.12

20016 Pero (Milano - Italy)

Tel. +39 02 3535955 r.a. Fax. +39 02 3539929

E-Mail: info@omar-alluminio.it



Profilati in alluminio per impianti Fotovoltaici/Calorici

Gamma completa per:
 -Profili in alluminio grezzo / ossidazione naturale in barre da mt.6
 -Accessori adatti alla realizzazione di strutture



Via Newton, n.12
 20016 Pero (Milano - Italy)
 Tel.+39 02 3535955 r.a. Fax.+39 02 3539929
 E-Mail: info@omar-alluminio.it

Cataloghi Online: www.omar-alluminio.it
www.omar-alluminio.com

PROFILATI ALLUMINIO A DISEGNO / STANDARD / SPECIALI / E PER
 ELETTRONICA / LED / FOTOVOLTAICO / AUTOMAZIONE ROBOTICA / PNEUMATICA / AUTOMOTIVE

PROFILO BLOCCA
 PANNELLO CENTRALE
 705 758 etc..

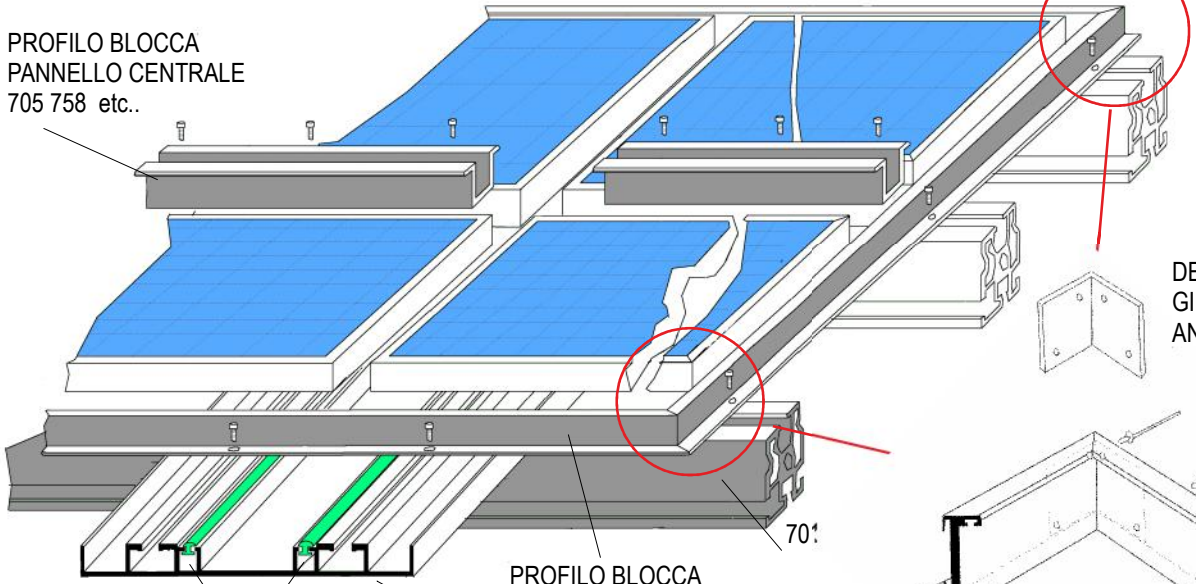

DETTAGLIO
 GIUNZIONE
 ANGOLO

RIVETTI

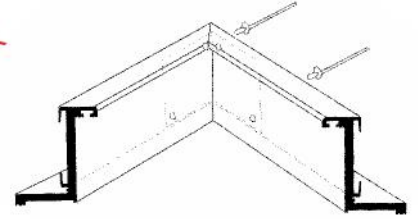

GUARNIZIONI COD EPDM738 ROTOLI DA MT.150



PROFILO BLOCCA
 PANNELLO LATERALE
 321 322 etc..

FISSAGGIO EVENTUALE
 LATTONERIA SOTTO TEGOLE

DISEGNI AL VERO (1:1)- SCALE 1:1

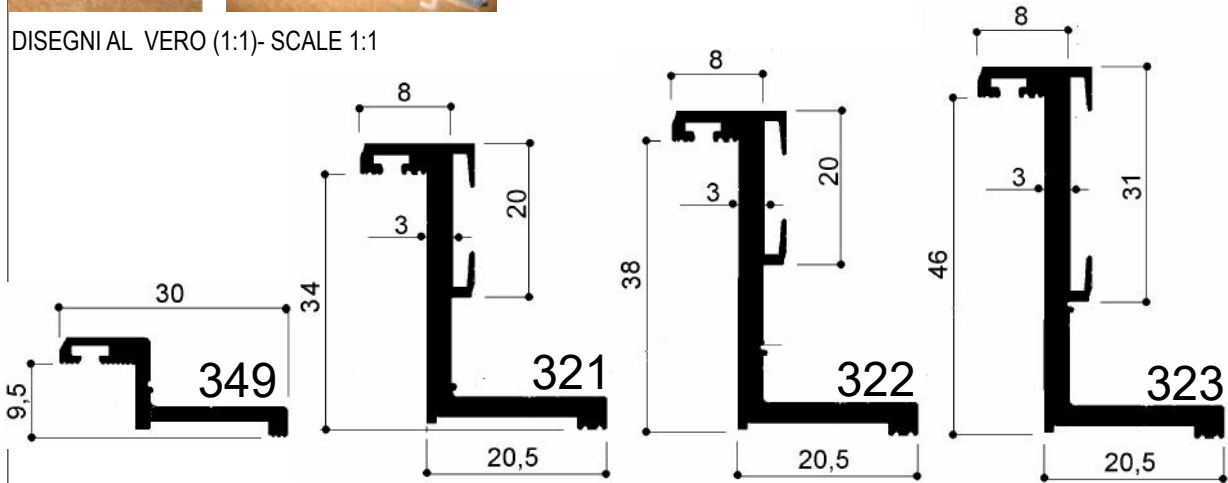

RIVETTO PER FISSARE
 LA LATTONERIA AL PROFILO
 LATTONERIA - SCOSSALINA



EPDM712

PROFILO DI GUARNIZIONE IN MATERIALE
 PLASTICO (EPDM). ROTOLI DA MT 300

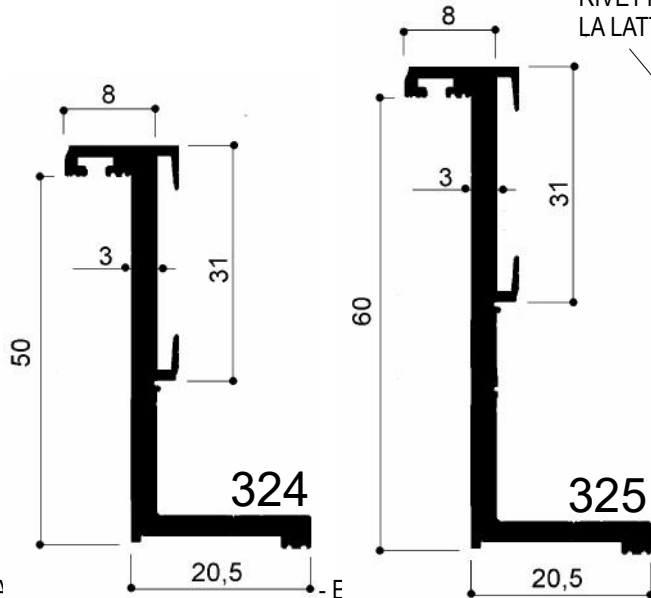

BULLONE M8

CAVA PER L'UTILIZZO
 DELLA GUARNIZIONE
 COD.EPDM712

ZONA PER POSIZIONARE L'EVENTUALE
 SPESSORE ED OTTENERE
 VARIE MISURE DI MODULO

AGGIORNAMENTO CONTINUO - ED. DEL 03-2023

-RIPRODUZIONE VIETATA-
 E' possibile fornire barre in lunghezza MASSIMA di 9 mt. grezzo e anodizzato



Profilati in alluminio per impianti Fotovoltaici/Calorici

Gamma completa per:

- Profili in alluminio grezzo / ossidazione naturale in barre da mt.6
- Accessori adatti alla realizzazione di strutture

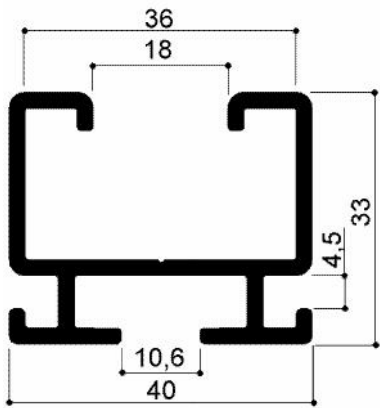

351

Cod.FM351:
Peso teorico Kg/mt: 0,829
Momento d'inerzia: Jx: 3,701 cm⁴
Jy: 6,738 cm⁴

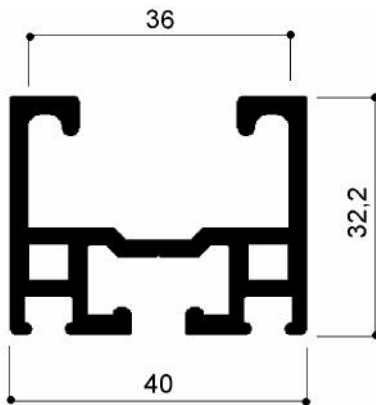

318

Cod.FM318:
Peso teorico Kg/mt: 0,911
Momento d'inerzia: Jx: 3,332 cm⁴
Jy: 7,305 cm⁴

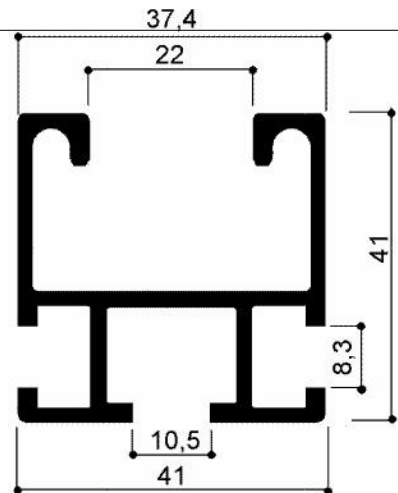

352

Cod.FM352:
Peso teorico Kg/mt: 0,984

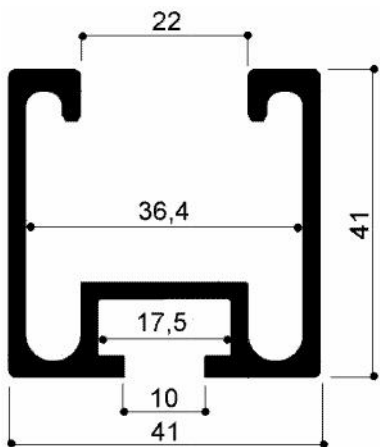

384

Cod.FM384:
Peso teorico Kg/mt: 1,124
Momento d'inerzia: Jx: 8,231 cm⁴
Jy: 10,082 cm⁴

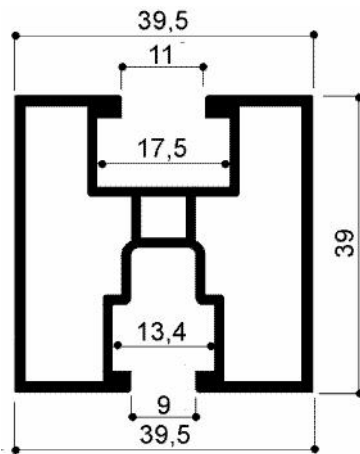

383

Cod.FM383:
Peso teorico Kg/mt: 0,931
Momento d'inerzia: Jx: 5,9255 cm⁴
Jy: 6,0581 cm⁴

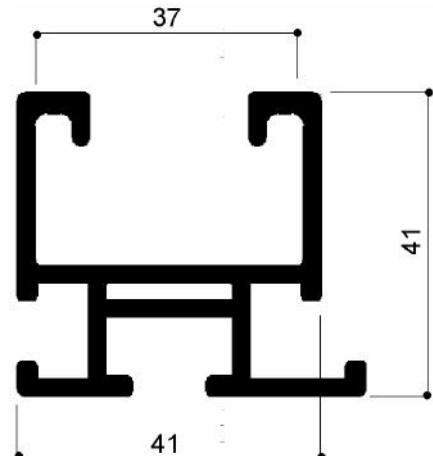

326

Cod.FM326:
Peso teorico Kg/mt: 1,142
Momento d'inerzia: Jx: 7,249 cm⁴
Jy: 19,396 cm⁴

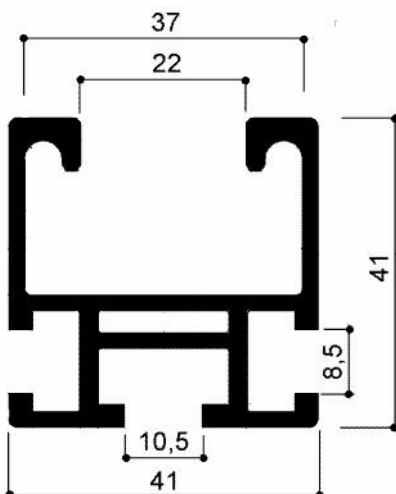

799

Cod.FM384:
Peso teorico Kg/mt: 1,205

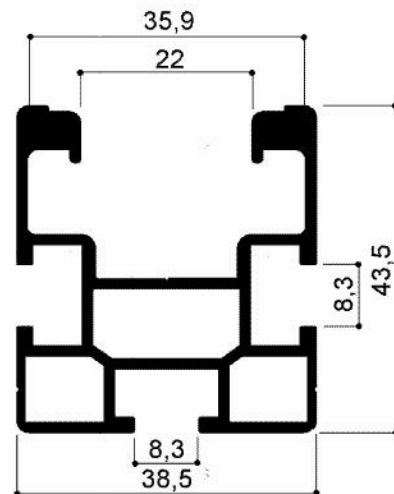

378

Cod.FM378:
Peso teorico Kg/mt: 0,974
Momento d'inerzia: Jx: 6,839 cm⁴
Jy: 7,289 cm⁴

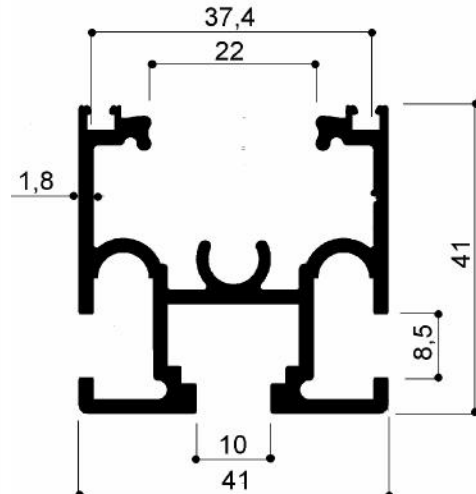

329

Cod.FM329:
Peso teorico Kg/mt: 0,974
Momento d'inerzia: Jx: 5,838 cm⁴
Jy: 7,729 cm⁴

Cataloghi Online: www.omar-alluminio.it

www.omar-alluminio.com

PROFILATI ALLUMINIO A DISEGNO / STANDARD / SPECIALI / E PER
ELETTRONICA / LED / FOTOVOLTAICO / AUTOMAZIONE ROBOTICA / PNEUMATICA / AUTOMOTIVE

Via Newton, n.12

20016 Pero (Milano - Italy)

Tel. +39 02 3535955 r.a. Fax. +39 02 3539929

E-Mail: info@omar-alluminio.it



Profilati in alluminio per impianti Fotovoltaici/Calorici

Gamma completa per:

- Profili in alluminio grezzo / ossidazione naturale in barre da mt.6
- Accessori adatti alla realizzazione di strutture



Via Newton, n.12
20016 Pero (Milano - Italy)
Tel.+39 02 3535955 r.a. Fax.+39 02 3539929
E.Mail: info@omar-alluminio.it

Cataloghi Online: www.omar-alluminio.it
www.omar-alluminio.com

PROFILATI ALLUMINIO A DISEGNO / STANDARD / SPECIALI / E PER
ELETTRONICA / LED / FOTOVOLTAICO / AUTOMAZIONE ROBOTICA / PNEUMATICA / AUTOMOTIVE

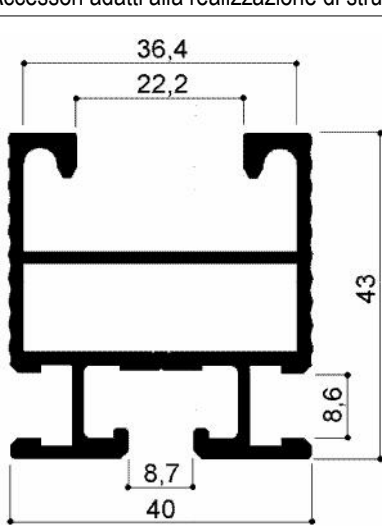

320

Cod.FM320:
Peso teorico Kg/mt: 1,125
Momento d'inerzia: Jx: 7,600 cm4
Jy: 8,420 cm4

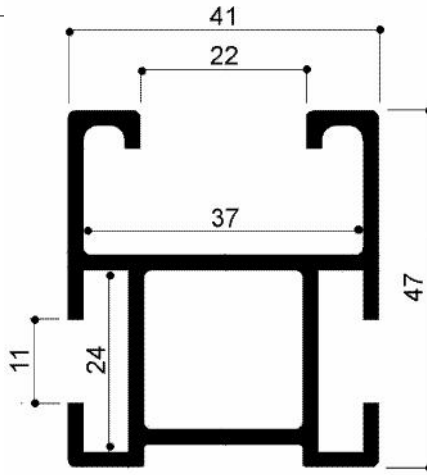

382

Cod.FM382:
Peso teorico Kg/mt: 1,170
Momento d'inerzia: Jx: 9,351 cm4
Jy: 9,608 cm4

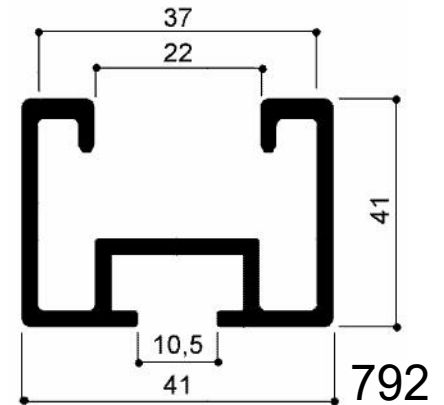

792

Cod.FM792:
Peso teorico Kg/mt: 0,813

DISEGNI AL VERO (1:1)- SCALE 1:1

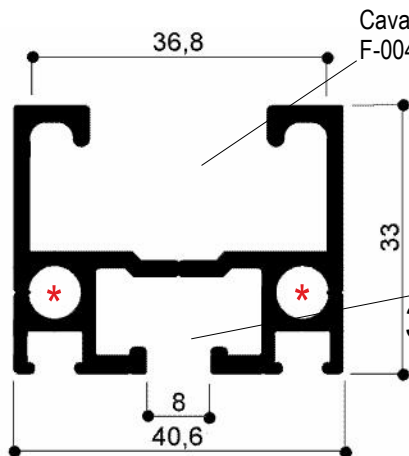

Cava compatibile con F-0048 e F-0045

Cava compatibile con 3-5341 4-0019

379

Cod.FM379:
Peso teorico Kg/mt: 0,975
Momento d'inerzia: Jx: 3,551 cm4
Jy: 8,056 cm4

Foro con diametro 6,6 con tacca di bulinatura adatto all'alloggiamento di un tondino in acciaio diametro 6



* Fori diametro 6,6 utilizzabili per inserire tondini diametro 6mm per effettuare prolunghe/giunzioni del profilo

DISEGNI AL VERO (1:1)- SCALE 1:1

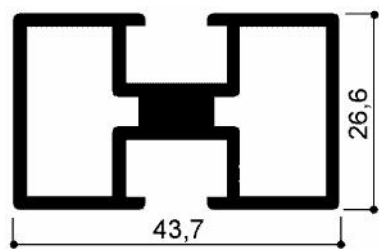

355

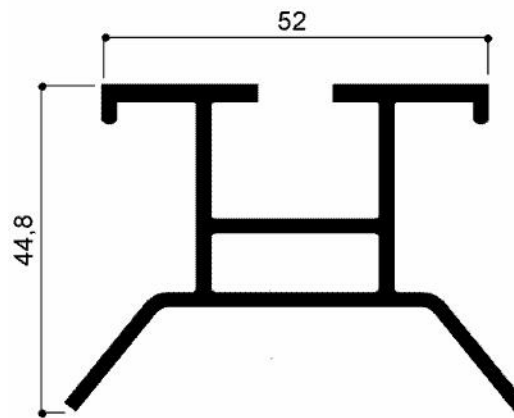

390

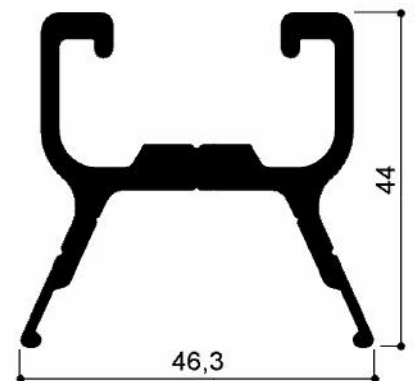

356

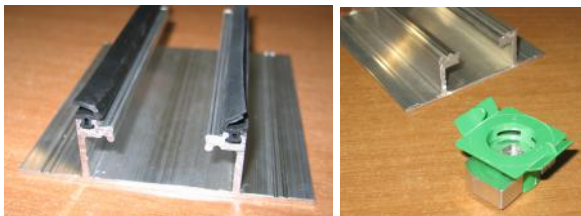

Profilati in alluminio per impianti Fotovoltaici/Calorici



Gamma completa per:

-Profili in alluminio grezzo / ossidazione naturale in barre da mt.6

-Accessori adatti alla realizzazione di strutture

Profilo in alluminio per fissaggio di moduli fotovoltaici su coperture formate da lastre grecate

CAVA PER L'EVENTUALE APPLICAZIONE DELLA GUARNIZIONE
COD. EPDM712

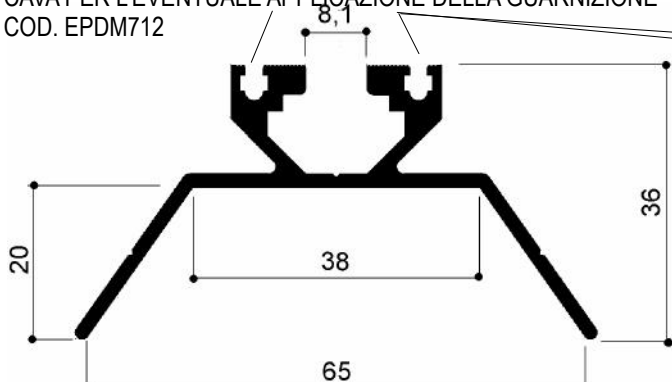

331

Cod.FM331:
Peso teorico Kg/mt: 0,745
Momento d'inerzia: Jx: 2,641 cm⁴
Jy: 8,004 cm⁴

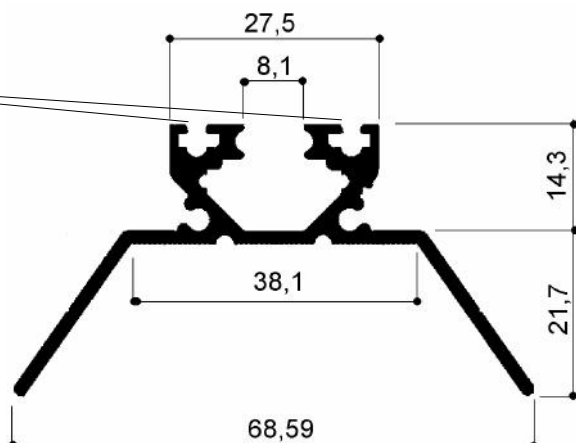

368

Cod.FM368:
Peso teorico Kg/mt: 0,696
Momento d'inerzia: Jx: 2,237 cm⁴
Jy: 7,740 cm⁴

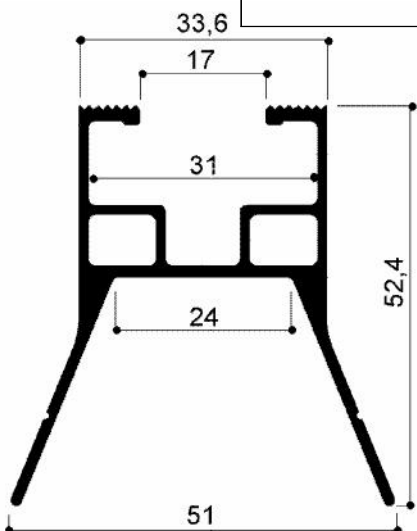

385

Cod.FM385:
Peso teorico Kg/mt: 0,810
Momento d'inerzia: Jx: 5,361 cm⁴
Jy: 6,948 cm⁴



EPDM712

PROFILO DI GUARNIZIONE IN MATERIALE PLASTICO (EPDM). ROTOLI DA MT 300

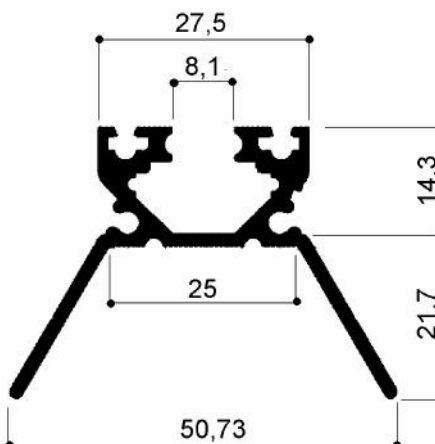

370

Cod.FM370:
Peso teorico Kg/mt: 0,632
Momento d'inerzia: Jx: 2,168 cm⁴
Jy: 4,173 cm⁴

2276

Cod.FM2276:
Peso teorico Kg/mt: 1,490
Momento d'inerzia: Jx: 42,431 cm⁴
Jy: 9,595 cm⁴

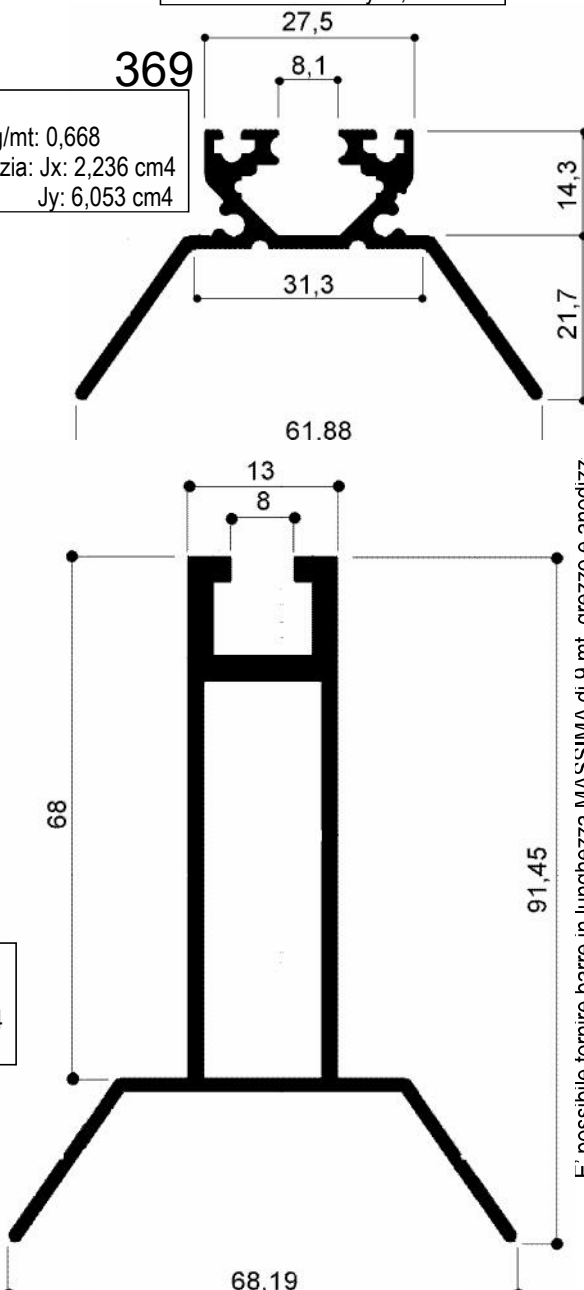

369

Cod.FM369:
Peso teorico Kg/mt: 0,668
Momento d'inerzia: Jx: 2,236 cm⁴
Jy: 6,053 cm⁴

DISEGNIAL VERO (1:1)- SCALE 1:1

E' possibile fornire barre in lunghezza MASSIMA di 9 mt. grezzo e anodizz

Cataloghi Online: www.omar-alluminio.it

www.omar-alluminio.com

PROFILATI ALLUMINIO A DISEGNO / STANDARD / SPECIALI / E PER

ELETTRONICA / LED / FOTOVOLTAICO / AUTOMAZIONE ROBOTICA / PNEUMATICA / AUTOMOTIVE



Via Newton, n.12

20016 Pero (Milano - Italy)

Tel. +39 02 3535955 r.a. Fax. +39 02 3539929

E-Mail: info@omar-alluminio.it

Profilati in alluminio per impianti Fotovoltaici/Calorici



Gamma completa per:

- Profili in alluminio grezzo / ossidazione naturale in barre da mt.6
- Accessori adatti alla realizzazione di strutture

PROFILI PER STRUTTURE DI SOSTEGNO PANNELLI SOLARI

DISEGNI AL VERO (1:1)- SCALE 1:1

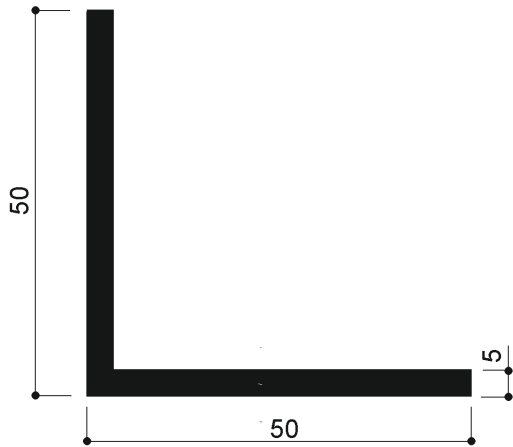
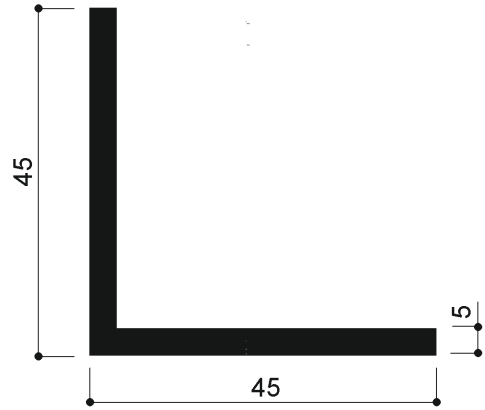
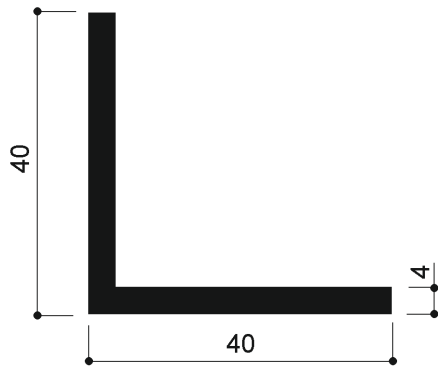

ESEMPI DI STRUTTURE REALIZZABILI CON ANGOLARI IN ALLUMINIO. SI POSSONO FORNIRE STRUTTURE CON DIMENSIONI 'CUSTOM'

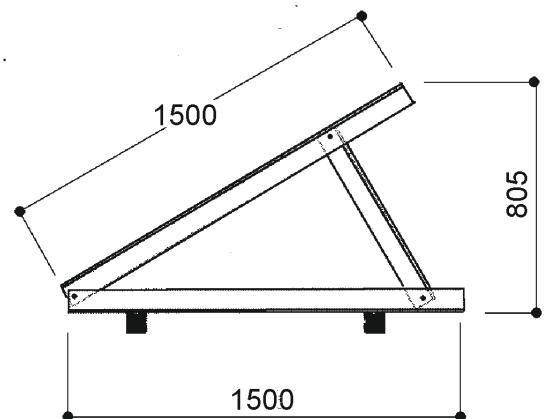
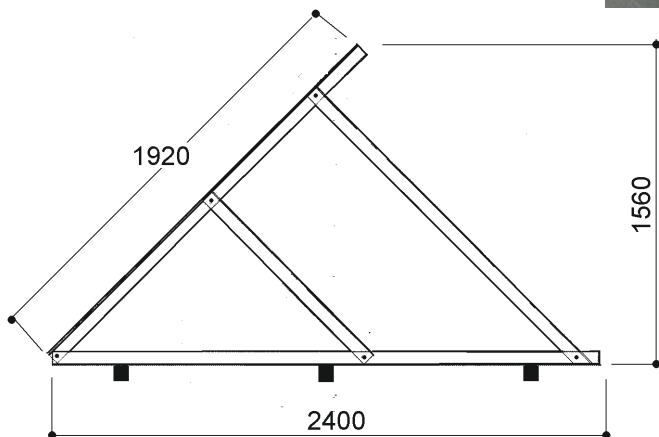
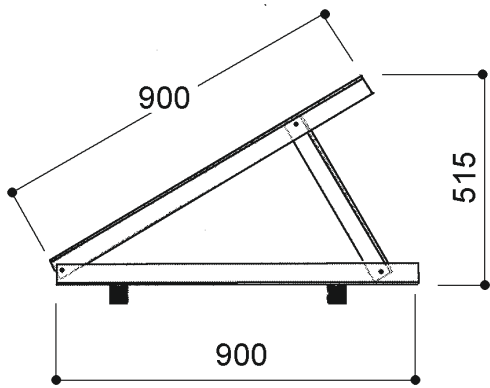

Via Newton, n.12

20016 Pero (Milano - Italy)

Tel. +39 02 3535955 r.a. Fax. +39 02 3539929

E-Mail: info@omar-alluminio.it

Cataloghi Online: www.omar-alluminio.it

www.omar-alluminio.com

PROFILATI ALLUMINIO A DISEGNO / STANDARD / SPECIALI / E PER
ELETTRONICA / LED / FOTVOLTAICO / AUTOMAZIONE ROBOTICA / PNEUMATICA / AUTOMOTIVE



Profilati in alluminio per impianti Fotovoltaici/Calorici

Gamma completa per:

- Profili in alluminio grezzo / ossidazione naturale in barre da mt.6
- Accessori adatti alla realizzazione di strutture



DISEGNI AL VERO (1:1)- SCALE 1:1

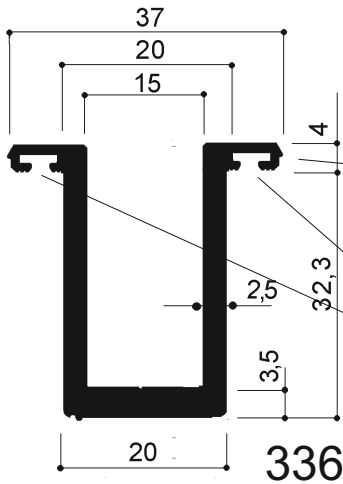

PROFILO IN ALLUMINIO
ANODIZZATO COPRI
CAVA A SCATTO

SCATTI PER IL FISSAGGIO
DEL PROFILO COPRI
CAVA COD.713

CAVE PER L'UTILIZZO
DELLA GUARNIZIONE
COD.EPDM712

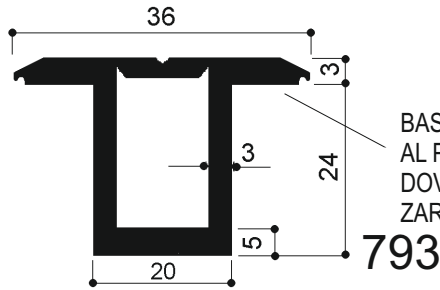
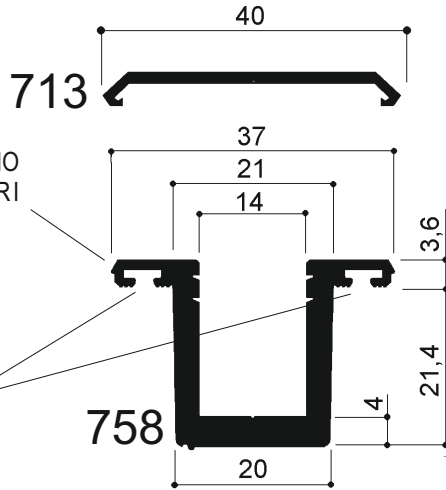

BASE DI ANCORAGGIO
AL PANNELLO ZIGRINATA
DOVE E' POSSIBILE UTILIZ-
ZARE PRODOTTI SIGILLANTI

388

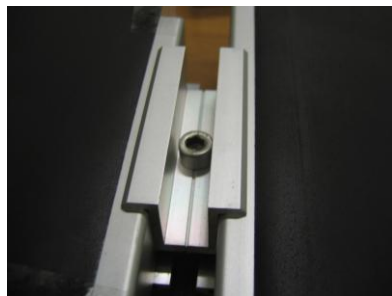
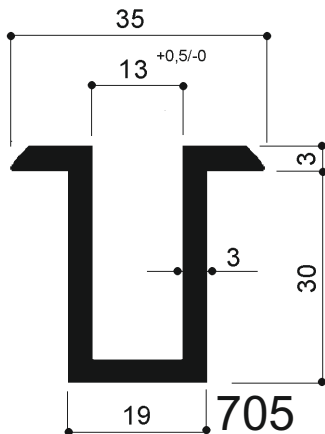

EPDM712

PROFILO DI GUARNIZIONE IN
MATERIALE PLASTICO (EPDM).
ROTTOLI DA MT 300

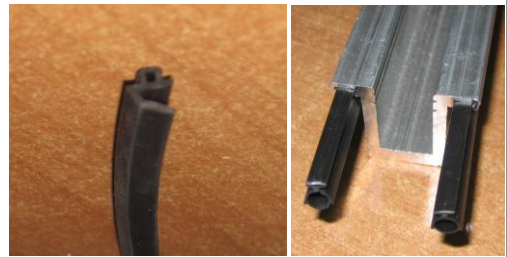

ESEMPIO DI UTILIZZO ART.336,
758, 712, 713, DISEGNI FUORI SCALA

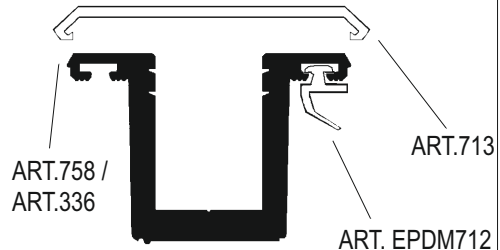

Cataloghi Online: www.omar-alluminio.it

www.omar-alluminio.com

PROFILATI ALLUMINIO A DISEGNO / STANDARD / SPECIALI / E PER

ELETTRONICA / LED / FOTOVOLTAICO / AUTOMAZIONE ROBOTICA / PNEUMATICA / AUTOMOTIVE

Via Newton, n.12

20016 Pero (Milano - Italy)

Tel. +39 02 3535955 r.a. Fax. +39 02 3539929

E-Mail: info@omar-alluminio.it



Profilati in alluminio per impianti Fotovoltaici/Calorici

Gamma completa per:

- Profili in alluminio grezzo / ossidazione naturale
- Accessori adatti alla realizzazione di strutture



ACCESSORI: STAFFA CENTRALE BLOCCA PANNELLO

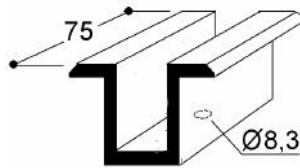
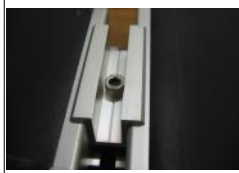

Staffa centrale da 75mm in alluminio ricavata da profilo 705 per il fissaggio dei pannelli ai profili strutturali (altezza pannello da 30mm a 60mm)
Cod.Art.4-0051 grezzo
Cod.Art.4-0051/A anodizzato argento

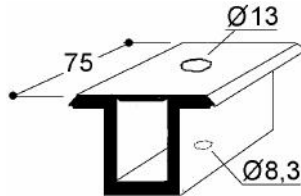
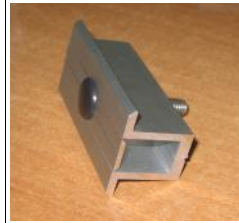
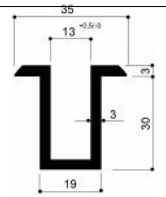

Staffa centrale da 75mm in alluminio ricavata da profilo 793 per il fissaggio dei pannelli ai profili strutturali (altezza pannello da 21mm a 60mm)
Cod.Art.4-0002 grezzo
Cod.Art.4-0002/A anodizzato argento

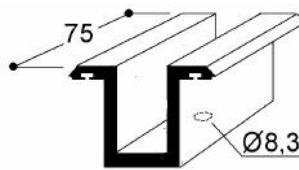
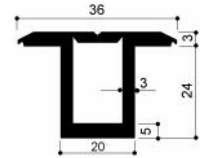

Staffa centrale da 75mm in alluminio ricavata dal profilo 758 per il fissaggio dei pannelli ai profili strutturali (altezza pannello da 21mm a 60mm)
Cod.Art.4-0052 grezzo
Cod.Art.4-0052/A anodizzato argento

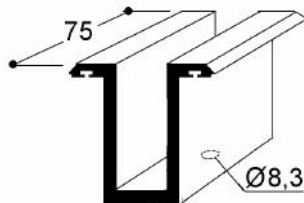
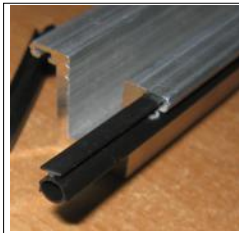
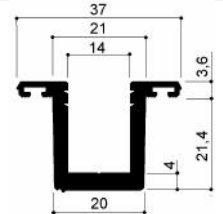

Staffa centrale da 75mm in alluminio ricavata dal profilo 336 per il fissaggio dei pannelli ai profili strutturali (altezza pannello da 32mm a 60mm)
Cod.Art.4-0074 grezzo
Cod.Art.4-0074/A anodizzato argento

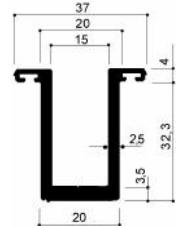

Profilo alluminio copri cava montabile a scatto anodizzato argento da utilizzare in caso necessiti dare continuita' alla superficie dei pannelli. Compatibile con cod.4-0002 4-0052 4-0065
Codice Art.4-0039

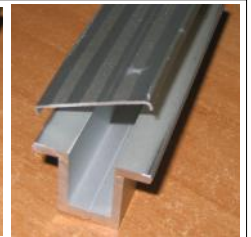
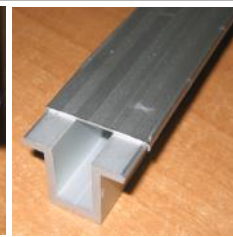
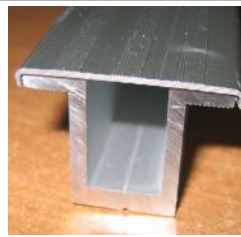
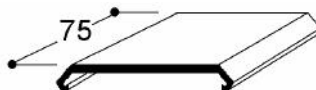

Art.4-0039

Art.4-0052

Art.4-0051

Esempi di utilizzo

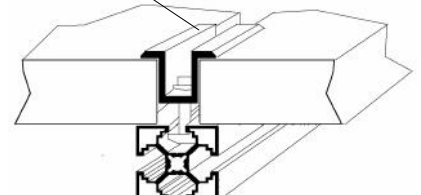
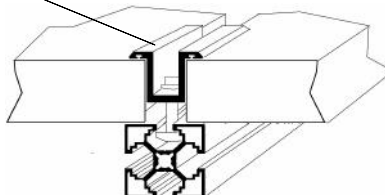
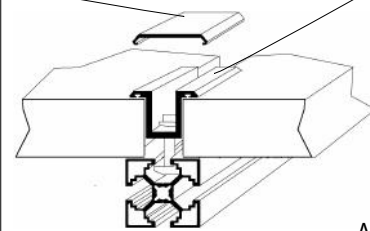

Art.4-0002

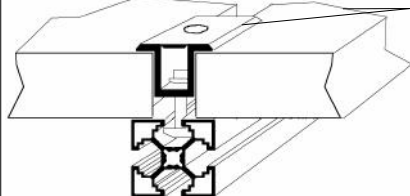

Via Newton, n.12

20016 Pero (Milano - Italy)

Tel.+39 02 3535955 r.a. Fax.+39 02 3539929

E-Mail: info@omar-alluminio.it

Cataloghi Online: www.omar-alluminio.it

www.omar-alluminio.com

PROFILATI ALLUMINIO A DISEGNO / STANDARD / SPECIALI / E PER
ELETTRONICA / LED / FOTOVOLTAICO / AUTOMAZIONE ROBOTICA / PNEUMATICA / AUTOMOTIVE

OMAR s.r.l.
PROFILATI ALLUMINIO
ALTA TECNOLOGIA

Profilati in alluminio per impianti Fotovoltaici/Calorici

Gamma completa per:

- Profili in alluminio grezzo / ossidazione naturale
- Accessori adatti alla realizzazione di strutture



DISEGNI AL VERO (1:1)- SCALE 1:1

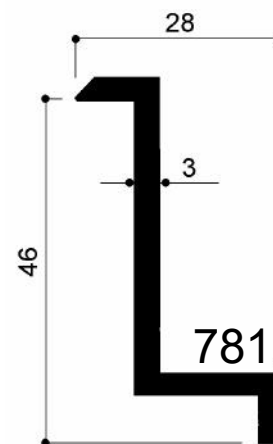
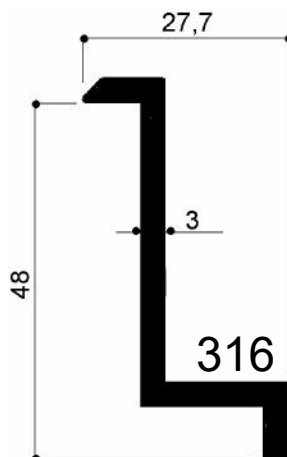
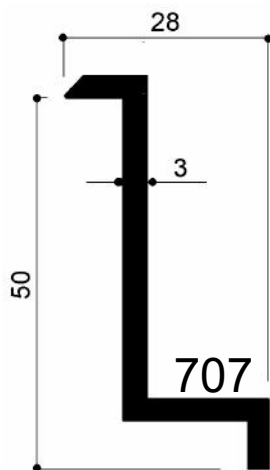
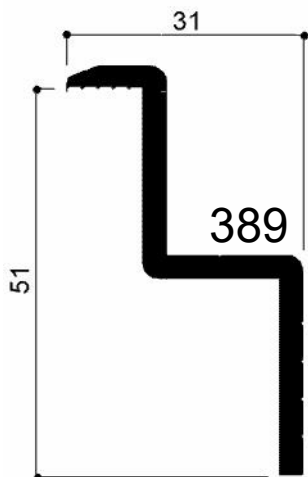
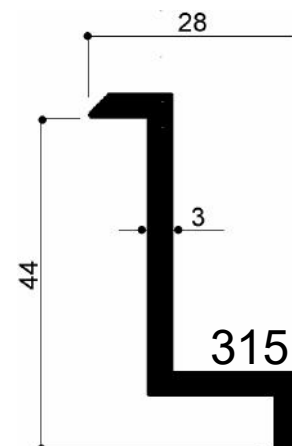
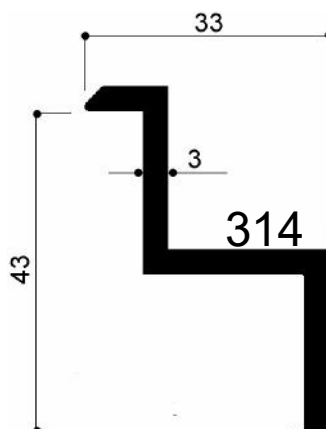
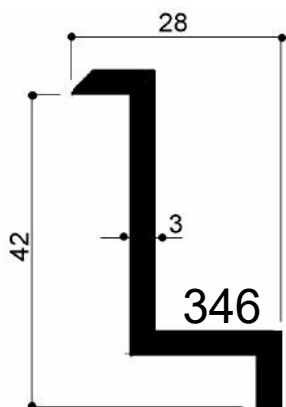
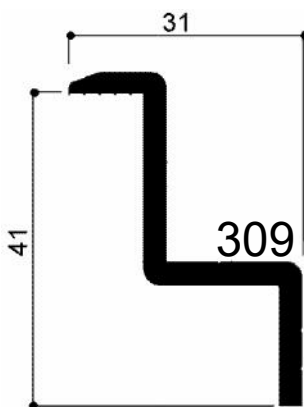
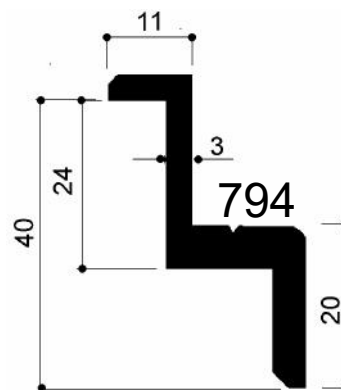
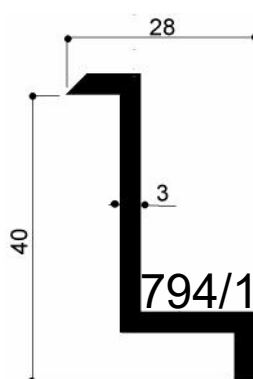
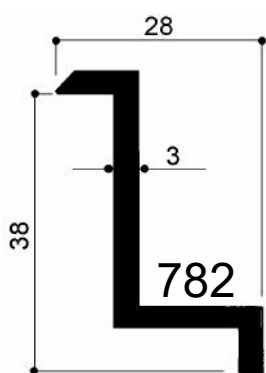
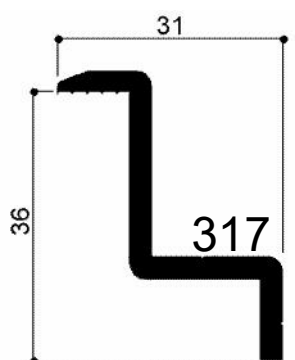
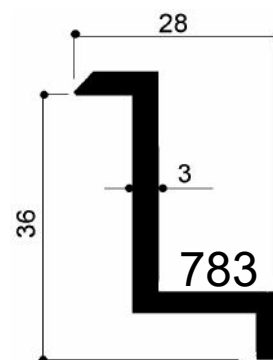
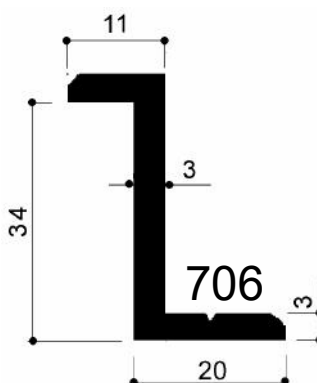
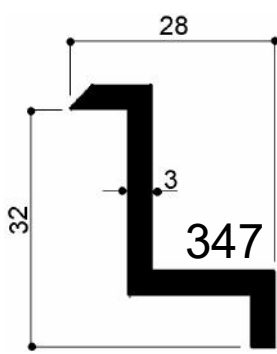
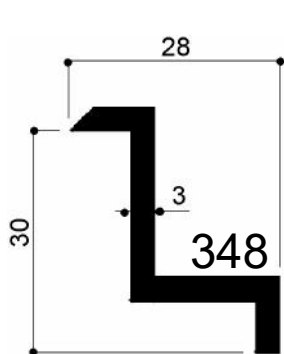

Profilati in alluminio per impianti Fotovoltaici/Calorici

Gamma completa per:

-Profili in alluminio grezzo / ossidazione naturale in barre da mt.6

-Accessori adatti alla realizzazione di strutture



ACCESSORI: STAFFA LATERALE BLOCCA PANNELLO

PANNELLI DA:		CODICE STAFFA	CODICE SPESSORE	LUNGHEZZA STAFFE / SPESSORE
30MM		4-0068		40
		4-0069		45
		4-0070		80
32MM		4-0071		40
		4-0072		45
		4-0073		80
35MM		4-0018		40
		4-0017		45
		4-0020		80
36 MM		4-0043		40
		4-0044		45
		4-0045		80
37MM		4-0018	4-0021	40
		4-0017	4-0024	45
		4-0020	4-0027	80
38MM		4-0040		40
		4-0041		45
		4-0042		80
39MM		4-0018	4-0023	40
		4-0017	4-0026	45
		4-0020	4-0029	80
40MM		4-0012 (794)4-0079 (794/1)		40
		4-0030 (794)4-0080 (794/1)		45
		4-0031 (794)4-0081 (794/1)		80
42MM		4-0076		40
		4-0077		45
		4-0078		80
43MM		4-0056		40
		4-0057		45
		4-0058		80
44MM		4-0062		40
		4-0063		45
		4-0064		80
45MM FORO SPESSORE PER M6		4-0018	4-0032	40
		4-0017	4-0009	45
		4-0020	4-0037	80
46MM		4-0046		40
		4-0047		45
		4-0048		80
48MM		4-0059		40
		4-0060		45
		4-0061		80
50MM		4-0033		40
		4-0034		45
		4-0035		80
60MM FORO SPESSORE PER M6		4-0018	4-0036	40
		4-0017	4-0011	45
		4-0020	4-0038	80

BULLONE TC M8+
CURSORE/PIASTRINA M8

PANNELLO SOLARE

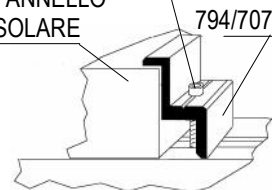

BULLONE TC M8+
CURSORE / PIASTRINA M8

PANNELLO SOLARE

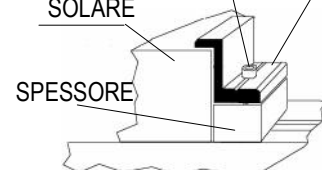

Staffe in alluminio anodizzato argento ricavate da profili 706 / 794 / 707 .
Si realizzano su richiesta staffe a vs. disegno

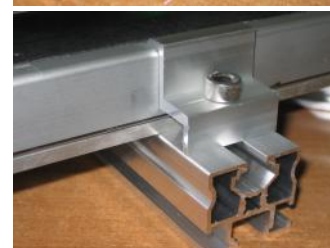
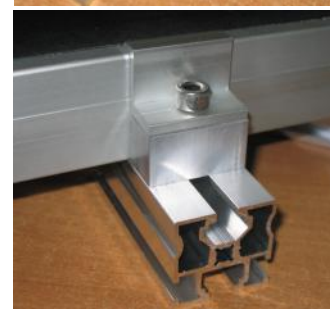

Profilati in alluminio per impianti Fotovoltaici/Calorici

Gamma completa per:

-Profili in alluminio grezzo / ossidazione naturale in barre da mt.6

-Accessori adatti alla realizzazione di strutture



ACCESSORI: STAFFA LATERALE BLOCCA PANNELLO

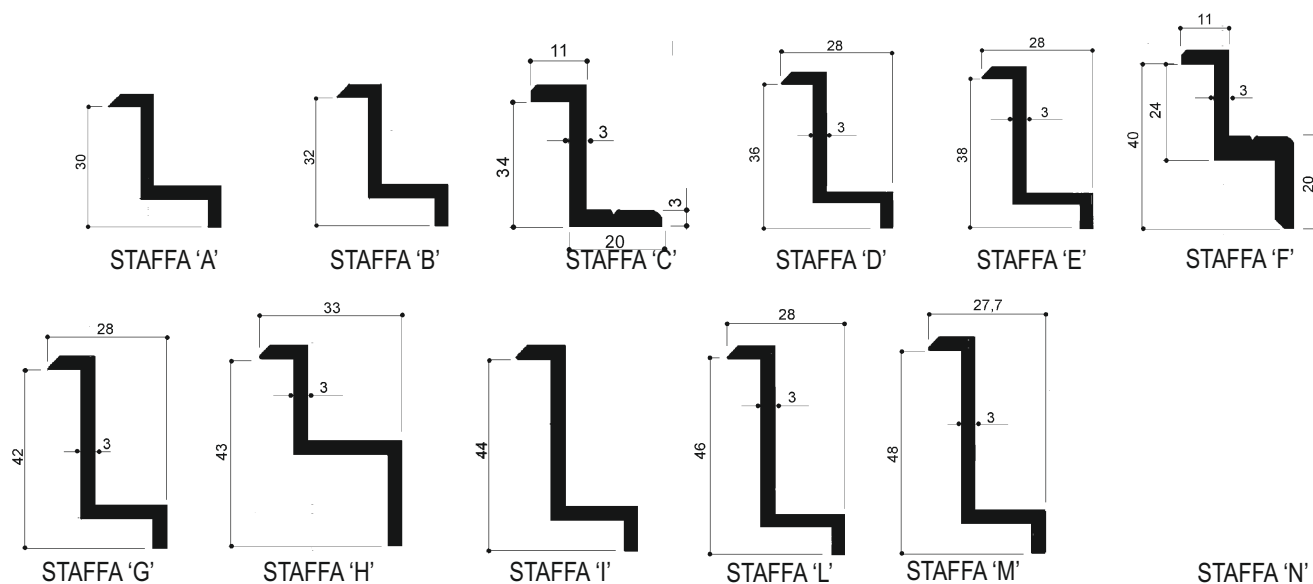

CODICI	TIPO STAFFA	L = LUNGHEZZA (MM)
4-0068	A	40
4-0069	A	45
4-0070	A	80
4-0071	B	40
4-0072	B	45
4-0073	B	80
4-0018	C	40
4-0017	C	45
4-0020	C	80
4-0043	D	40
4-0044	D	45
4-0045	D	80
4-0040	E	40
4-0041	E	45
4-0042	E	80
4-0012	F	40
4-0030	F	45
4-0031	F	80
4-0076	G	40
4-0077	G	45
4-0078	G	80
4-0056	H	40
4-0057	H	45
4-0058	H	80
4-0062	I	40
4-0063	I	45
4-0064	I	80
4-0046	L	40
4-0047	L	45
4-0048	L	80
4-0059	M	40
4-0060	M	45
4-0061	M	80
4-0033	N	40
4-0034	N	45
4-0035	N	80

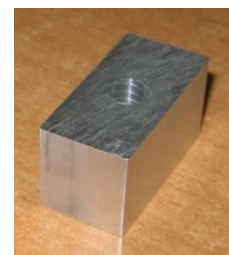
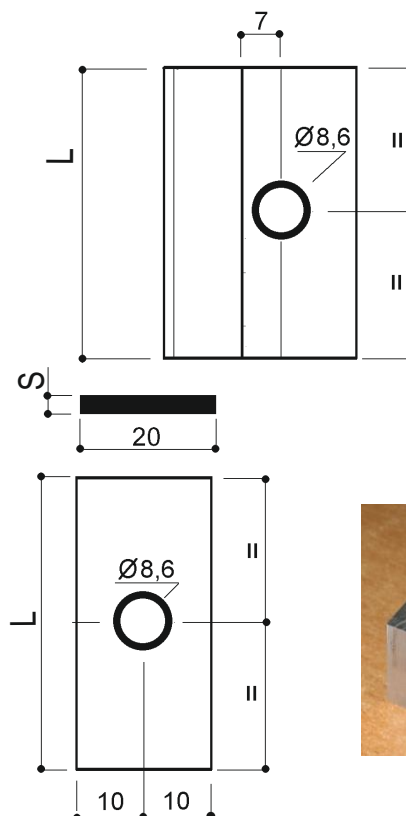

Via Newton, n.12

20016 Pero (Milano - Italy)

Tel. +39 02 3535955 r.a. Fax. +39 02 3539929

E-Mail: info@omar-alluminio.it

Cataloghi Online: www.omar-alluminio.it

www.omar-alluminio.com

PROFILATI ALLUMINIO A DISEGNO / STANDARD / SPECIALI / E PER:

ELETTRONICA / LED / FOTOVOLTAICO / AUTOMAZIONE ROBOTICA / PNEUMATICA / AUTOMOTIVE



Profili Speciali - Aluminium profile custom sections

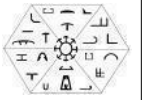

DISEGNI AL VERO (1:1)- SCALE 1:1

Cataloghi Online: www.omar-alluminio.it

www.omar-alluminio.com

PROFILATI ALLUMINIO A DISEGNO / STANDARD / SPECIALI / E PER:

ELETTRONICA / LED / FOTOVOLTAICO / AUTOMAZIONE ROBOTICA / PNEUMATICA / AUTOMOTIVE

Via Newton, n.12

20016 Pero (Milano - Italy)

Tel. +39 02 3535955 r.a. Fax. +39 02 3539929

E-Mail: info@omar-alluminio.it

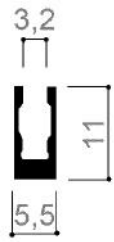

1303



1300

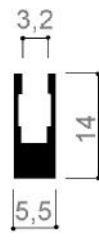

1306



1333



1312

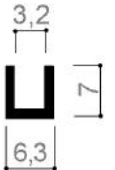

1315

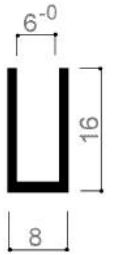

1326

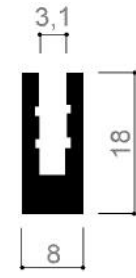

1309

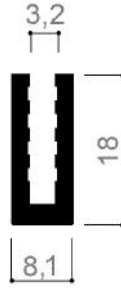

1322



1324



1313

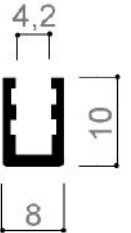

1302
OX ORO

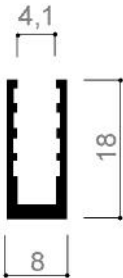

1321

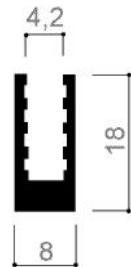

1308



1338



1325

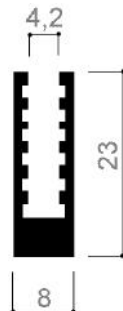

1323

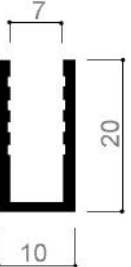

1329

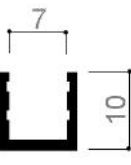

1328

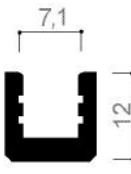

1330

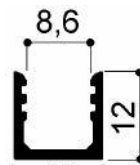

2048*

*PROFILO RISERVATO

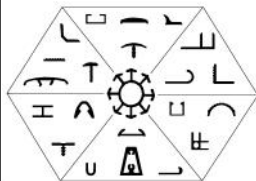

ANCHE PER MODESTE QUANTITA' SI POSSONO FORNIRE
PREVIO ALLESTIMENTO MATRICE, ULTERIORI PROFILI
SECONDO LE VS. SPECIFICHE

Profili in alluminio e scorrevoli per vetrinette



DISEGNI AL VERO (1:1)

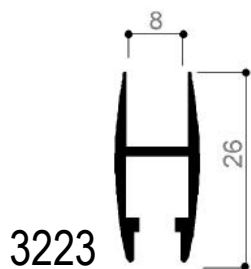

3223

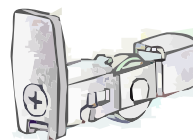
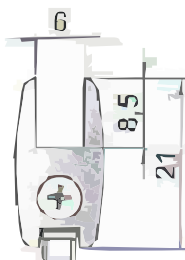

1621/D

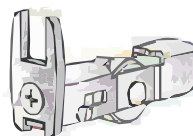

1621/D/F

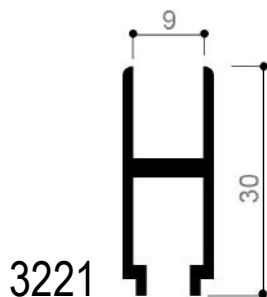

3221

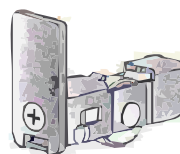
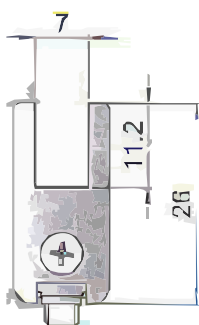
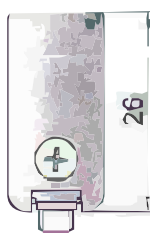

1824/N

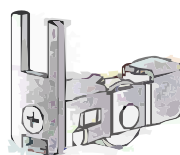

1824/N/F



3162

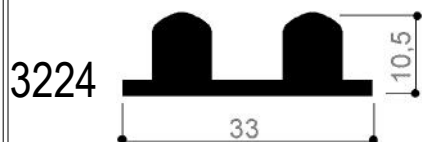

3224



3225

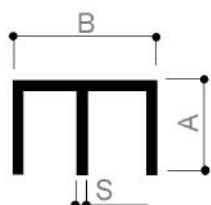

A x B x S
20x15x1
20x18x1,2
20x20x1

3222

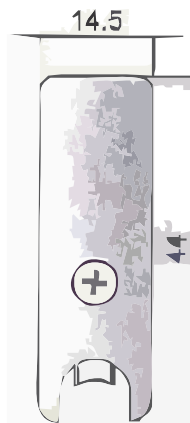
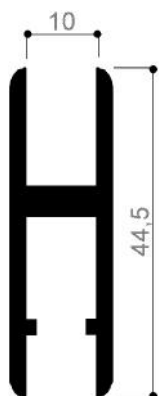

140-03

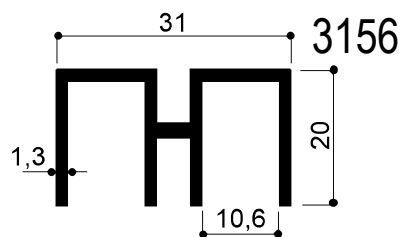

3156



FOTO DI ESEMPIO: DISSIPATORE
CON ALETTATURA MICRO PER
ILLUMINAZIONE A LED

Via Newton, n.12
20016 Pero (Milano - Italy)
Tel. +39 02 3535955 r.a. Fax. +39 02 3539929
E-Mail: info@omar-alluminio.it

Cataloghi Online: www.omar-alluminio.it
www.omar-alluminio.com

PROFILATI ALLUMINIO A DISEGNO / STANDARD / SPECIALI / E PER:
ELETTRONICA / LED / FOTOVOLTAICO / AUTOMAZIONE ROBOTICA / PNEUMATICA / AUTOMOTIVE

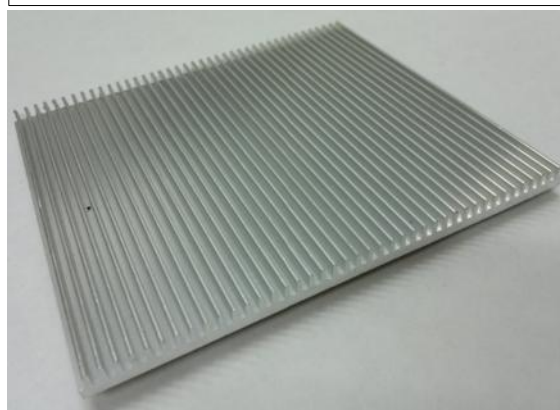

Profili Speciali - Aluminium profile custom sections



DISEGNI AL VERO (1:1)- SCALE 1:1

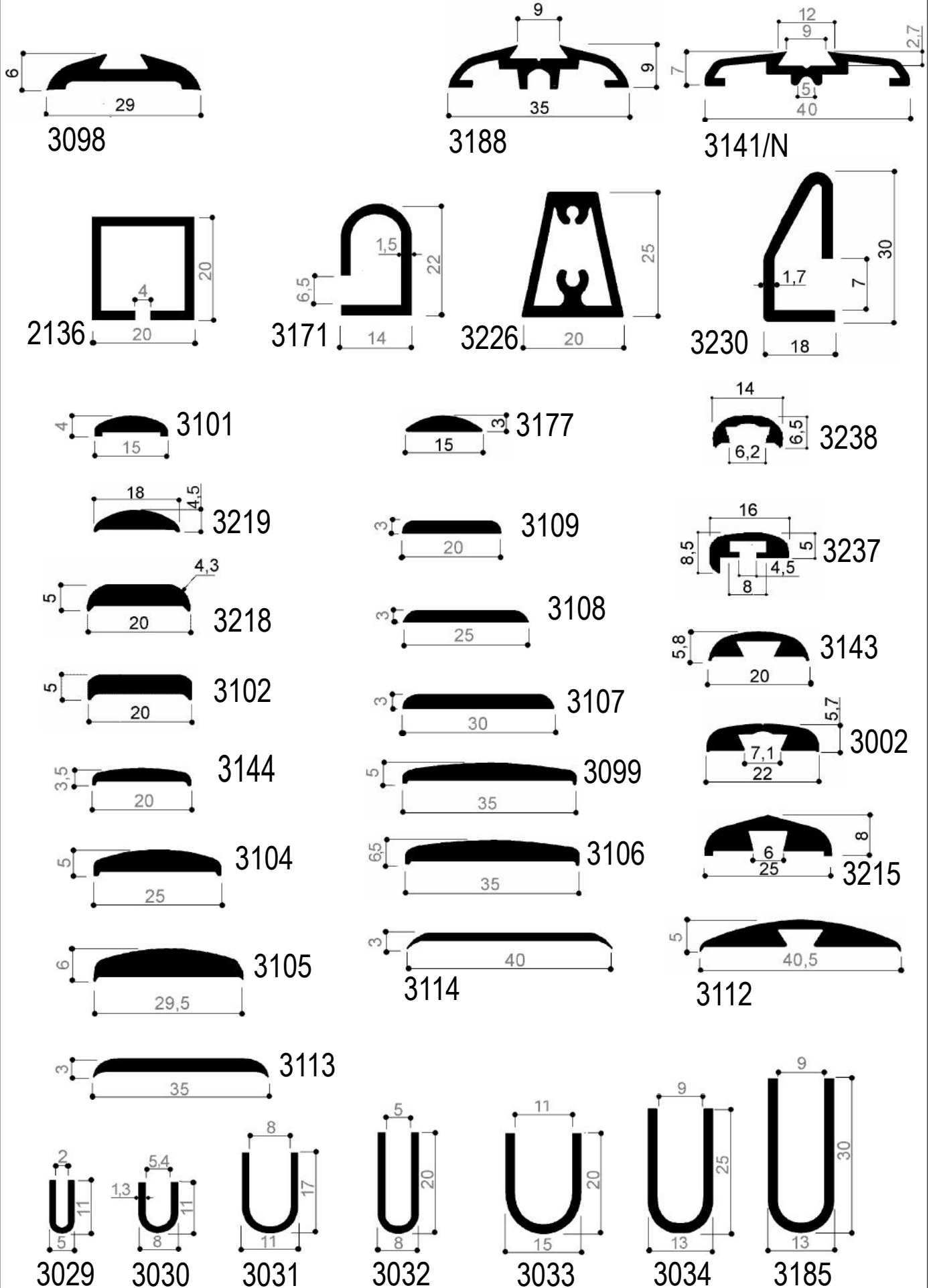

Cataloghi Online: www.omar-alluminio.it
www.omar-alluminio.com

Via Newton, n.12
 20016 Pero (Milano - Italy)
 Tel. +39 02 3535955 r.a. Fax. +39 02 3539929
 E-Mail: info@omar-alluminio.it

PROFILATI ALLUMINIO A DISEGNO / STANDARD / SPECIALI / E PER:
 ELETTRONICA / LED / FOTOVOLTAICO / AUTOMAZIONE ROBOTICA / PNEUMATICA / AUTOMOTIVE



Profili Speciali - Aluminium profile custom sections

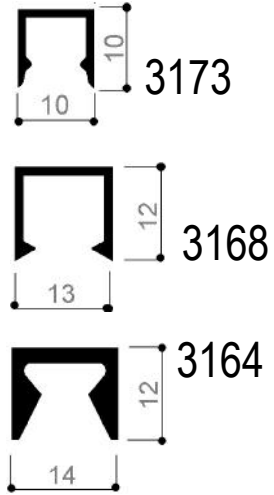
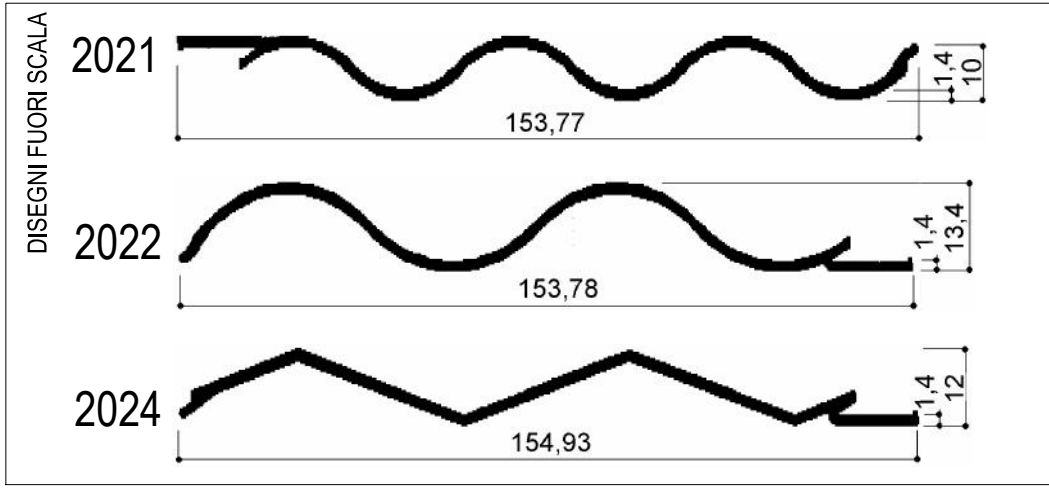
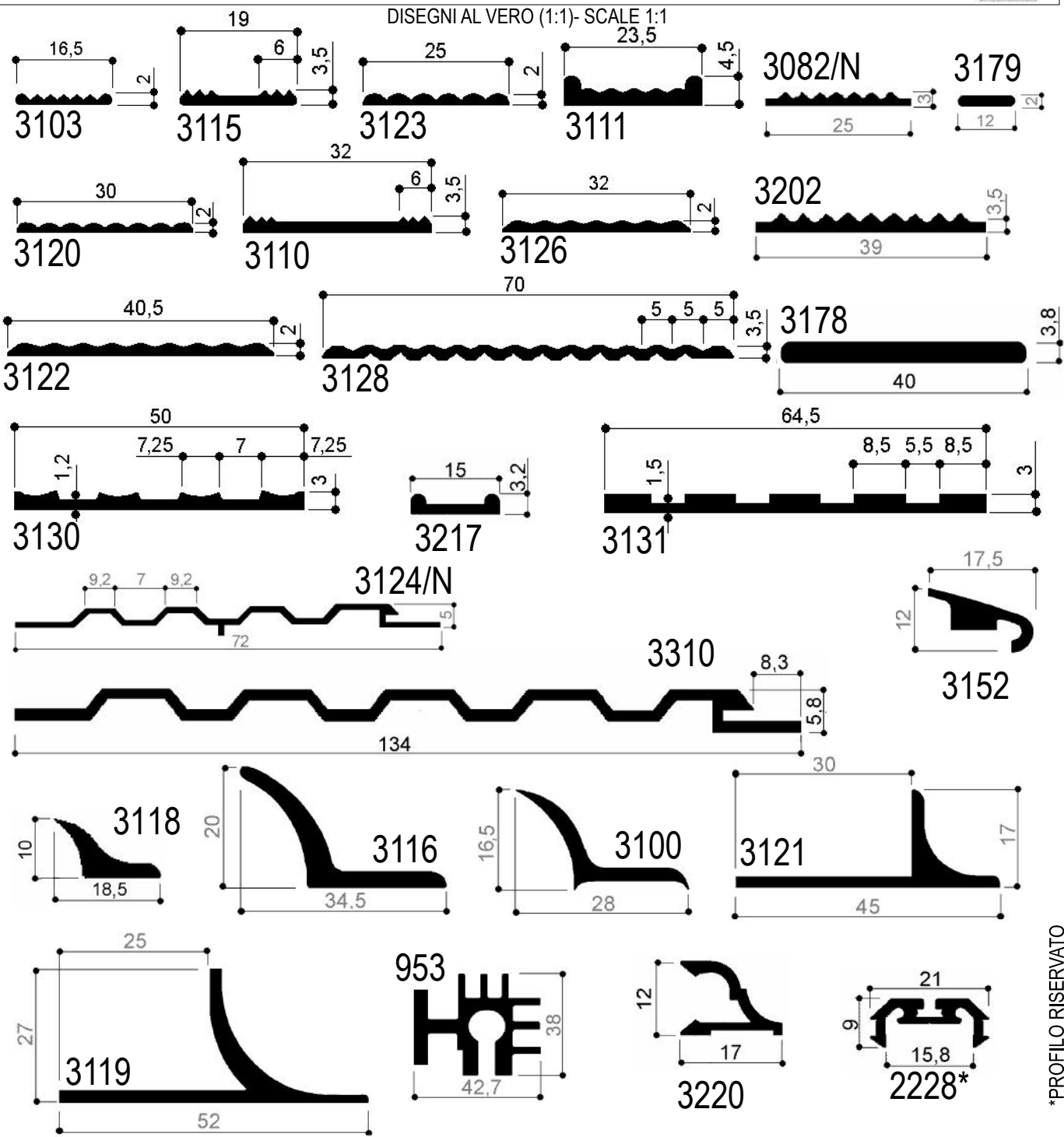

*PROFILO RISERVATO

Via Newton, n.12
20016 Pero (Milano - Italy)

Cataloghi Online: www.omar-alluminio.it
www.omar-alluminio.com

Tel. +39 02 3535955 r.a. Fax. +39 02 3539929
E-Mail: info@omar-alluminio.it

PROFILATI ALLUMINIO A DISEGNO / STANDARD / SPECIALI / E PER:
ELETTRONICA / LED / FOTOVOLTAICO / AUTOMAZIONE ROBOTICA / PNEUMATICA / AUTOMOTIVE



Profili Speciali - Aluminium profile custom sections



DISEGNI AL VERO (1:1) - SCALE 1:1

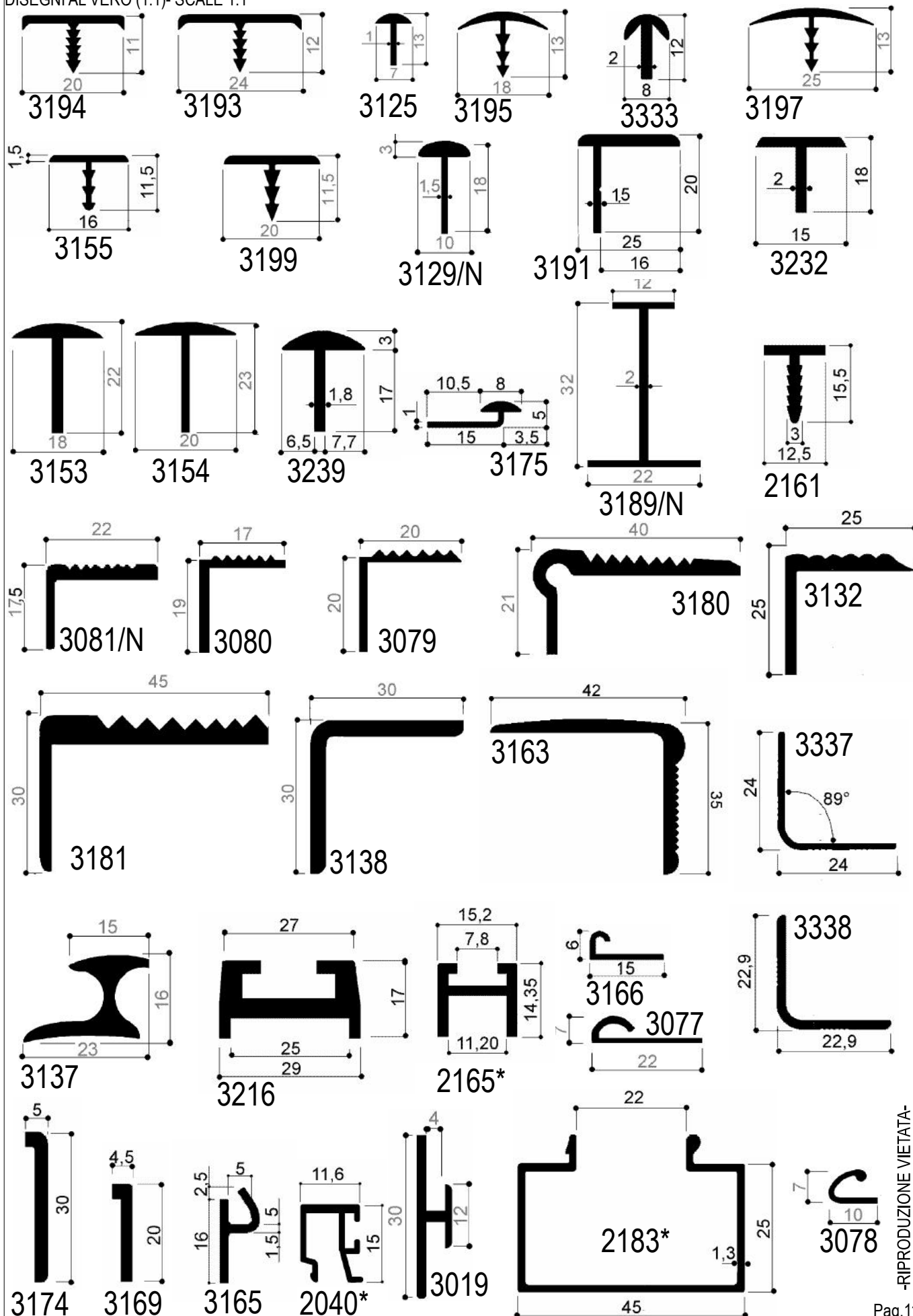

Via Newton, n.12
20016 Pero (Milano - Italy)
Tel. +39 02 3535955 r.a. Fax. +39 02 3539929
E-Mail: info@omar-alluminio.it

Cataloghi Online: www.omar-alluminio.it
www.omar-alluminio.com

PROFILATI ALLUMINIO A DISEGNO / STANDARD / SPECIALI / E PER:
ELETTRONICA / LED / FOTOVOLTAICO / AUTOMAZIONE ROBOTICA / PNEUMATICA / AUTOMOTIVE

-RIPRODUZIONE VIETATA-
AGGIORNAMENTO CONTINUO - ED. DEL 03-2023



Profili Speciali - Aluminium profile custom sections



Cataloghi Online: www.omar-alluminio.it
www.omar-alluminio.com

Via Newton, n.12
 20016 Pero (Milano - Italy)
 Tel. +39 02 3535955 r.a. Fax. +39 02 3539929
 E-Mail: info@omar-alluminio.it

PROFILATI ALLUMINIO A DISEGNO / STANDARD / SPECIALI / E PER:
 ELETTRONICA / LED / FOTOVOLTAICO / AUTOMAZIONE ROBOTICA / PNEUMATICA / AUTOMOTIVE

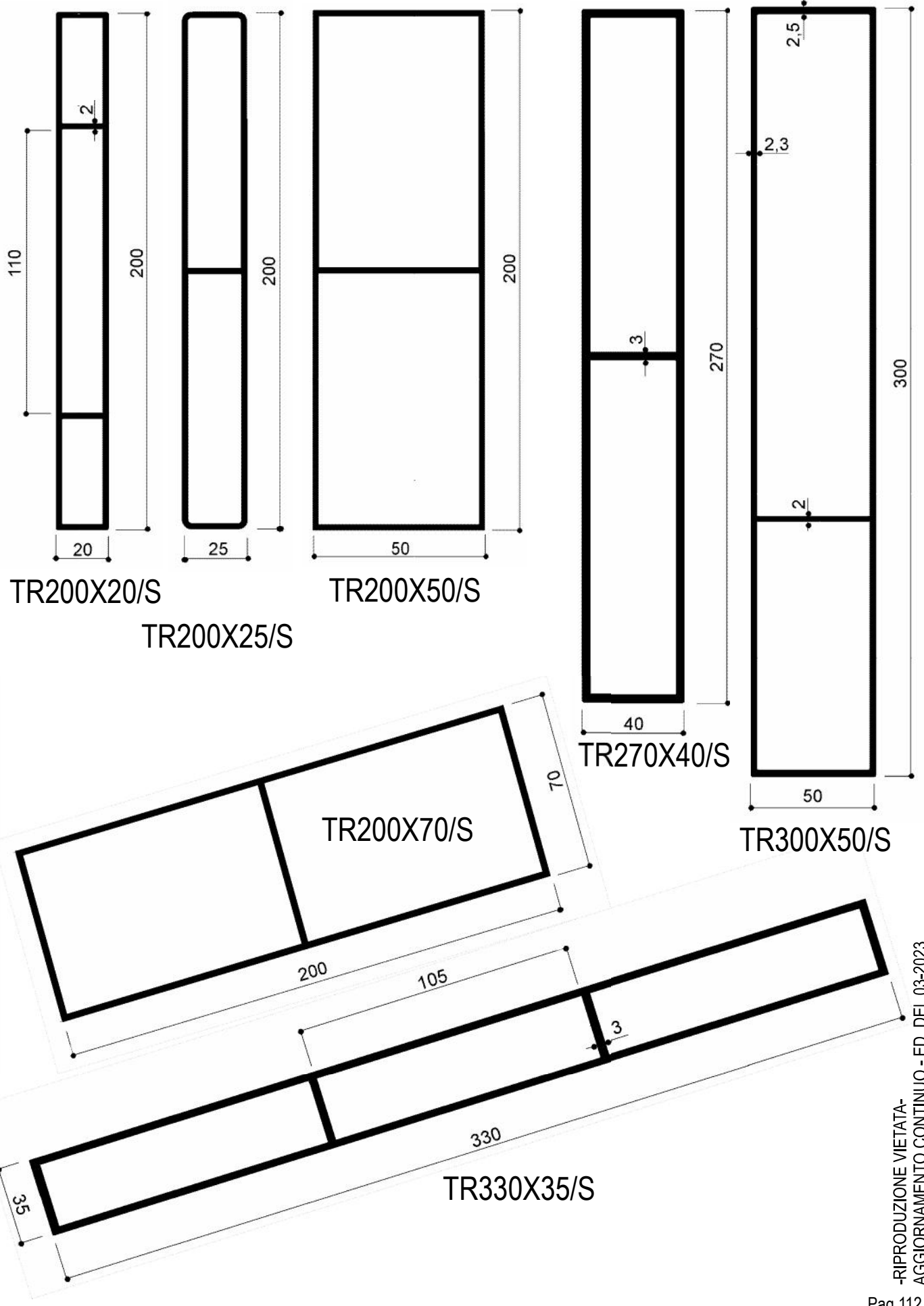

Profili Speciali - Aluminium profile custom sections

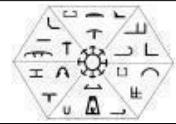

DISEGNI AL VERO (1:1)- SCALE 1:1

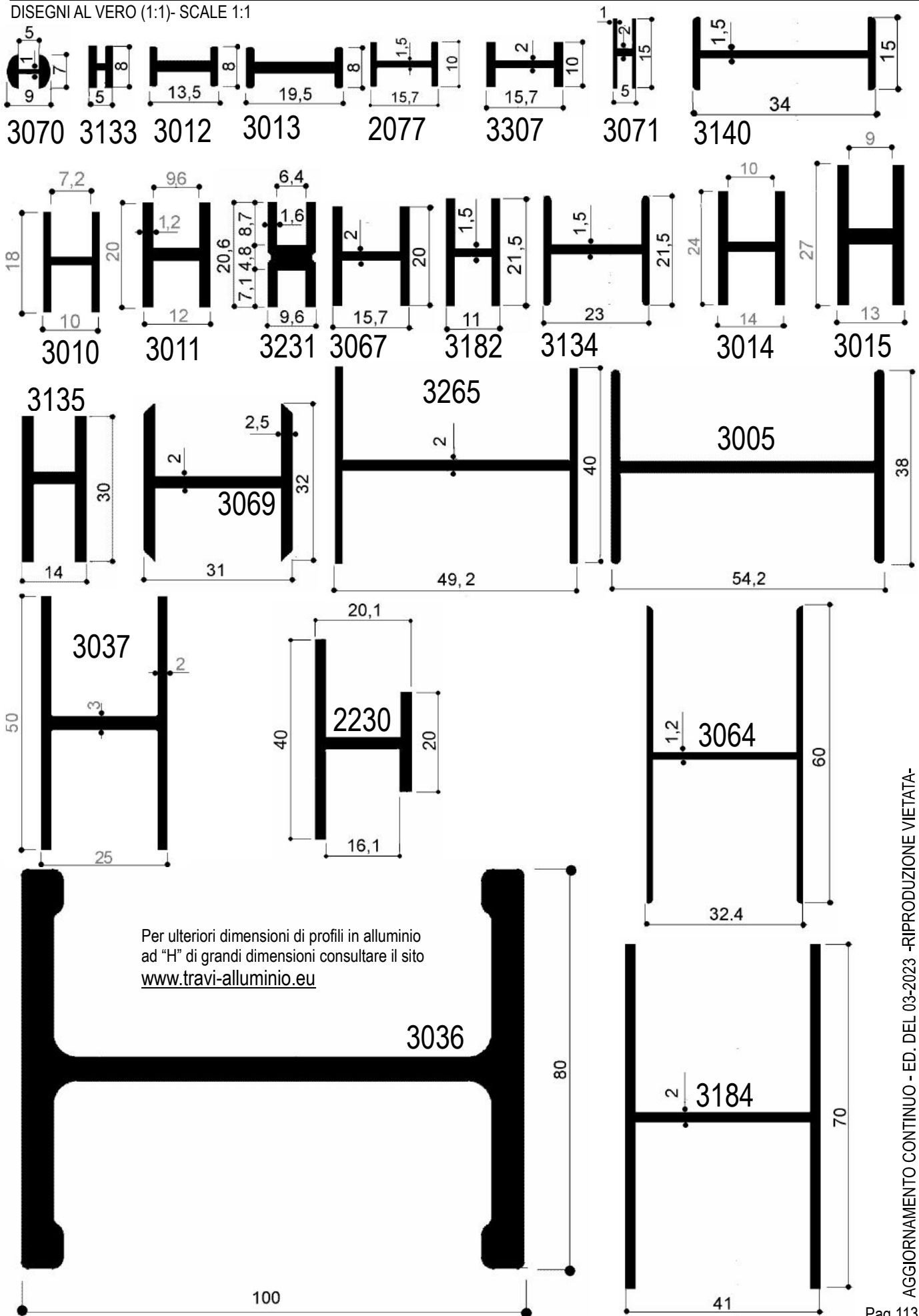

Per ulteriori dimensioni di profili in alluminio ad "H" di grandi dimensioni consultare il sito www.travi-alluminio.eu

AGGIORNAMENTO CONTINUO - ED. DEL 03-2023 - RIPRODUZIONE VIETATA-



Cataloghi Online: www.omar-alluminio.it

www.omar-alluminio.com

PROFILATI ALLUMINIO A DISEGNO / STANDARD / SPECIALI / E PER:

ELETTRONICA / LED / FOTOVOLTAICO / AUTOMAZIONE ROBOTICA / PNEUMATICA / AUTOMOTIVE

Via Newton, n.12

20016 Pero (Milano - Italy)

Tel.+39 02 3535955 r.a. Fax.+39 02 3539929

E-Mail: info@omar-alluminio.it

Profili Speciali - Aluminium profile custom sections

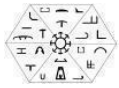

DISEGNI AL VERO (1:1) - SCALE 1:1

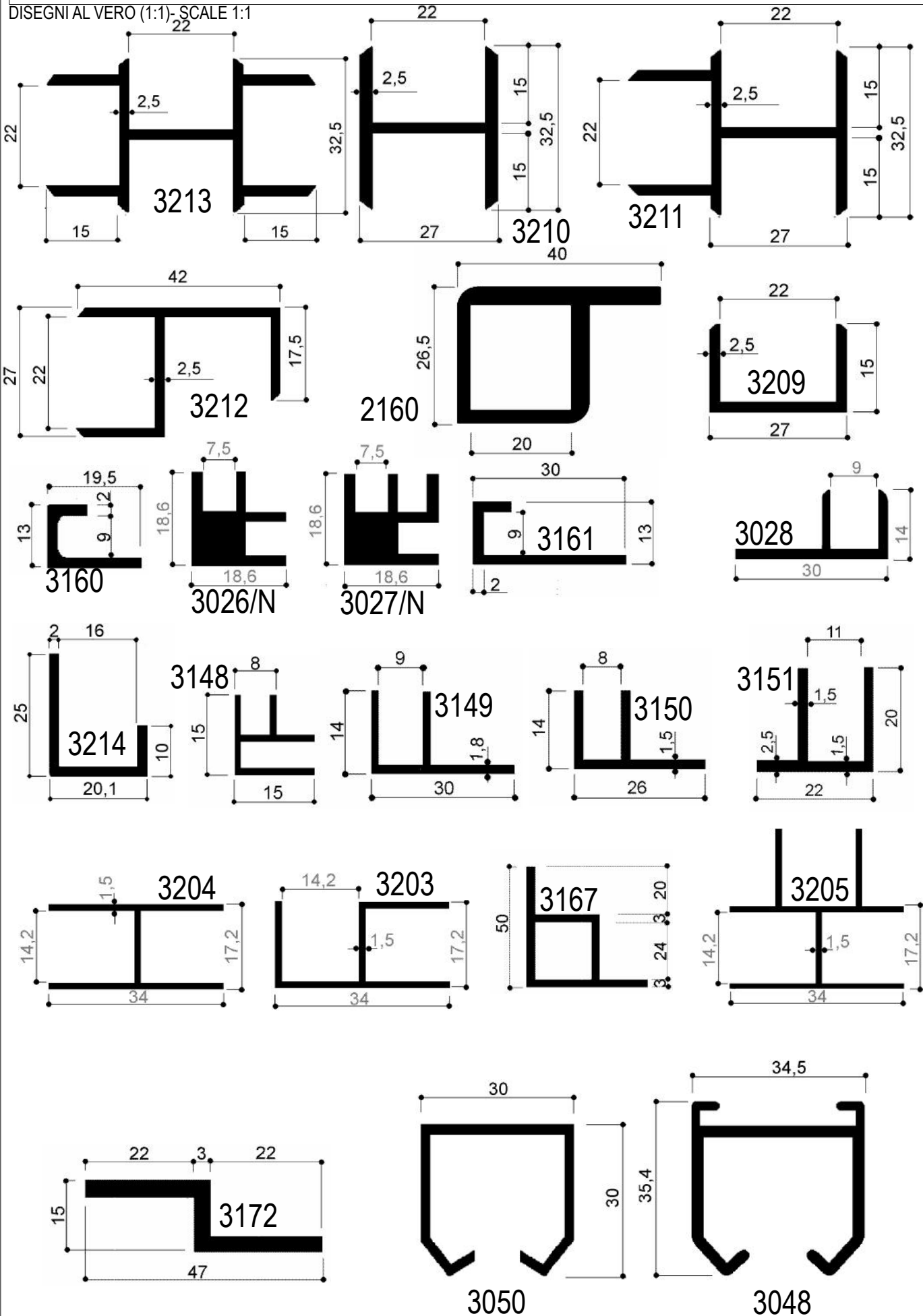

Cataloghi Online: www.omar-alluminio.it

www.omar-alluminio.com

PROFILATI ALLUMINIO A DISEGNO / STANDARD / SPECIALI / E PER:

ELETTRONICA / LED / FOTOVOLTAICO / AUTOMAZIONE ROBOTICA / PNEUMATICA / AUTOMOTIVE

Via Newton, n.12

20016 Pero (Milano - Italy)

Tel. +39 02 3535955 r.a. Fax. +39 02 3539929

E-Mail: info@omar-alluminio.it

OMAR s.p.a.
PROFILATI ALLUMINIO
ALTA TECNOLOGIA



DISEGNI AL VERO (1:1)

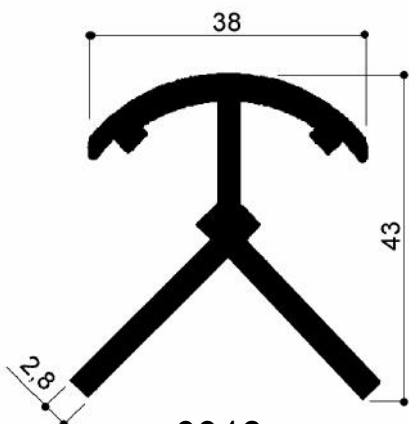

3312

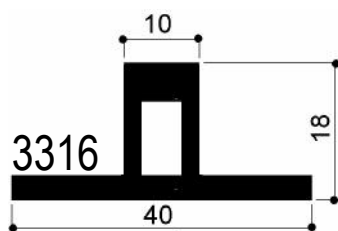

3316

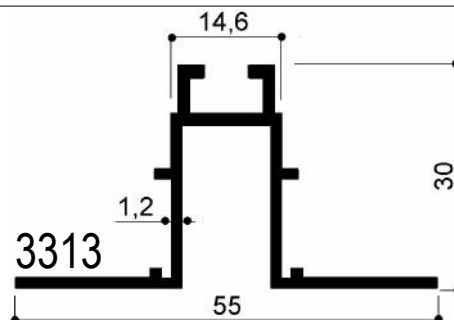

3313

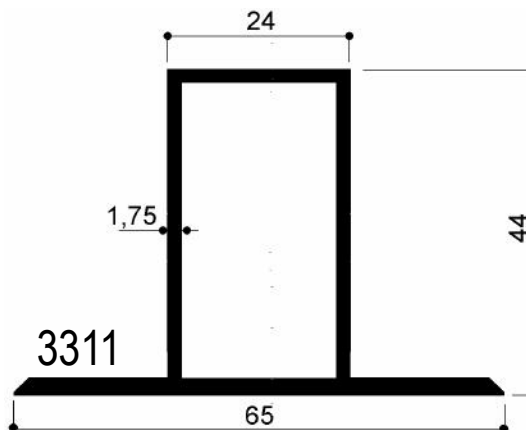

3311

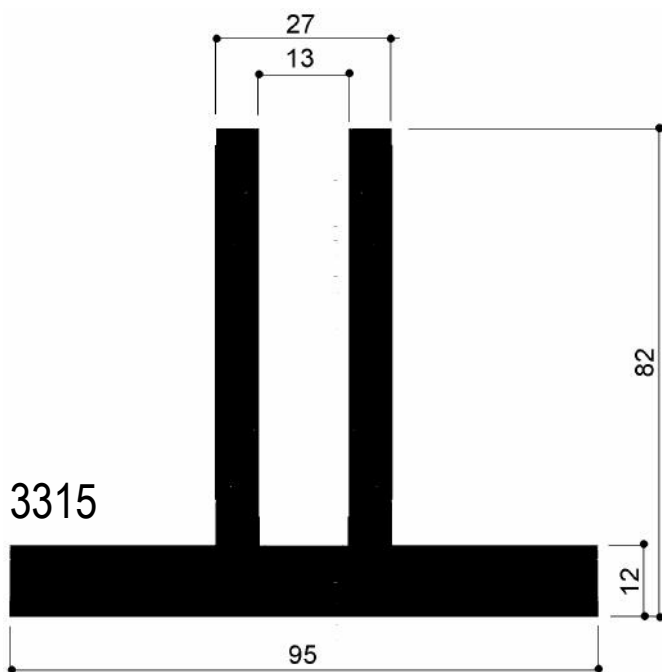

3315

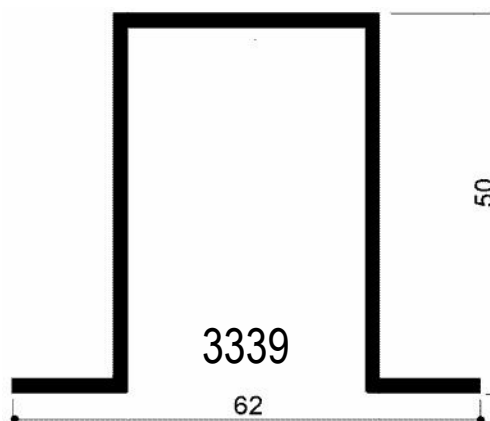

3339

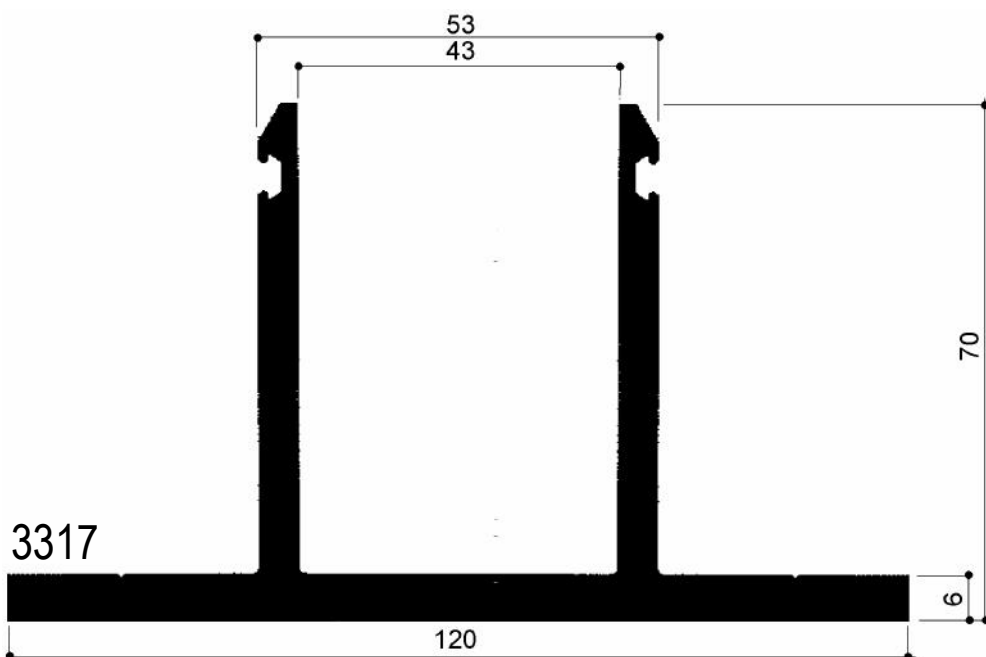

3317

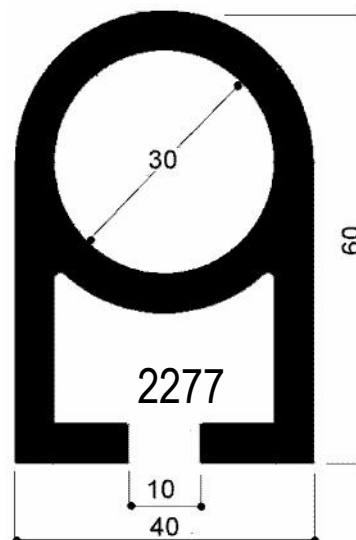

2277

Via Newton, n.12
20016 Pero (Milano - Italy)
Tel. +39 02 3535955 r.a. Fax. +39 02 3539929
E-Mail: info@omar-alluminio.it

Cataloghi Online: www.omar-alluminio.it
www.omar-alluminio.com

PROFILATI ALLUMINIO A DISEGNO / STANDARD / SPECIALI / E PER:
ELETTRONICA / LED / FOTOVOLTAICO / AUTOMAZIONE ROBOTICA / PNEUMATICA / AUTOMOTIVE



Profili Speciali - Aluminium profile custom sections



DISEGNI AL VERO (1:1)

Cataloghi Online: www.omar-alluminio.it

www.omar-alluminio.com

PROFILATI ALLUMINIO A DISEGNO / STANDARD / SPECIALI / E PER:

ELETTRONICA / LED / FOTOVOLTAICO / AUTOMAZIONE ROBOTICA / PNEUMATICA / AUTOMOTIVE

Via Newton, n.12

20016 Pero (Milano - Italy)

Tel. +39 02 3535955 r.a. Fax. +39 02 3539929

E-Mail: info@omar-alluminio.it

3318

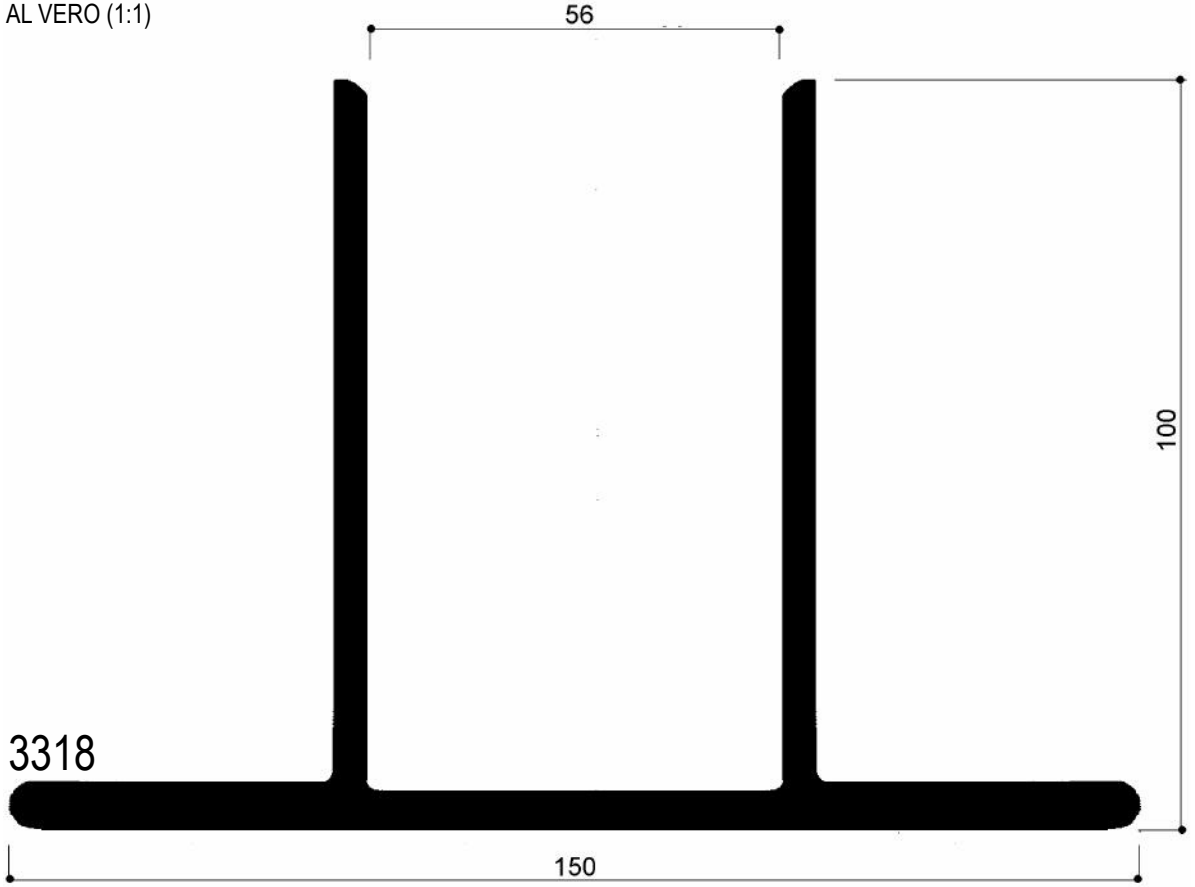

3340

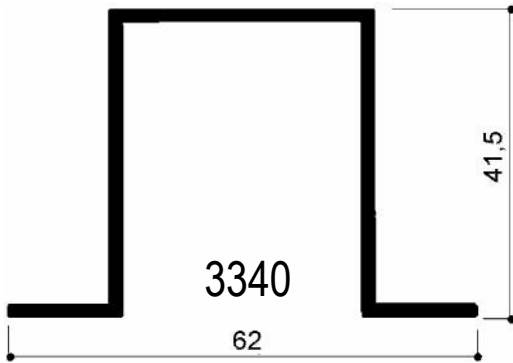

3336

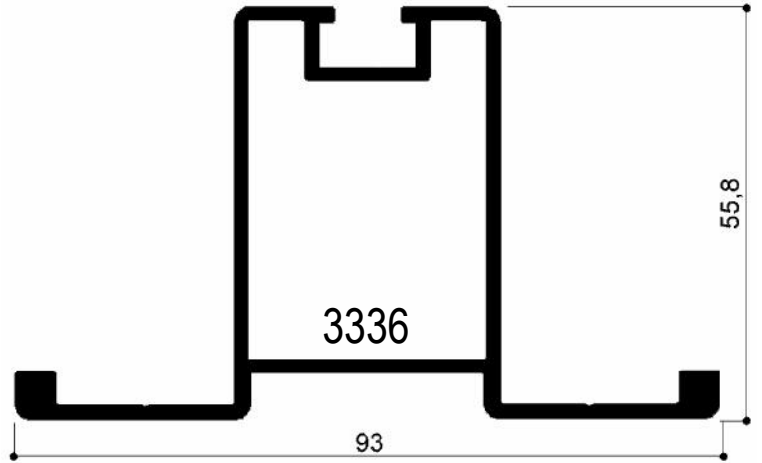

3018

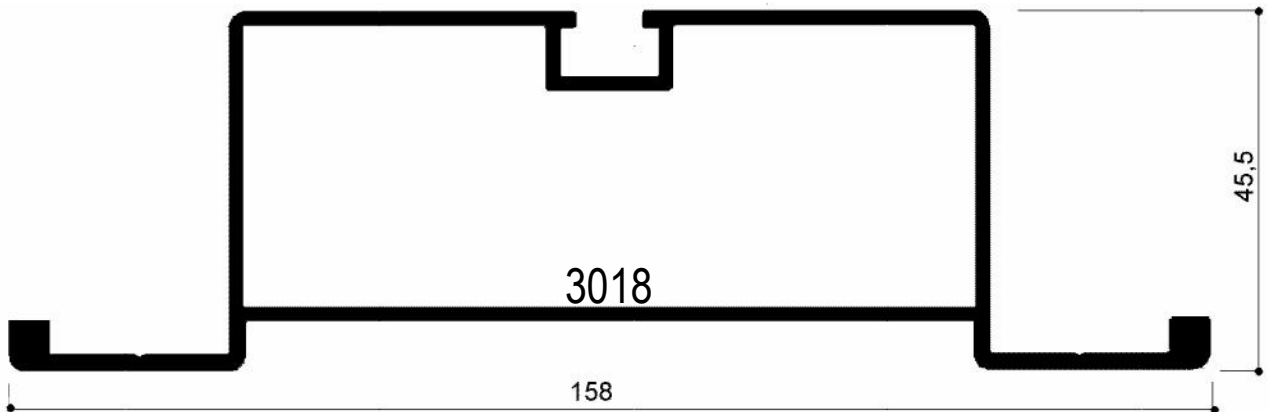

Profili Speciali - Aluminium profile custom sections

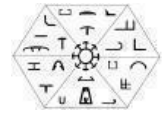

DISEGNI AL VERO (1:1)- SCALE 1:1

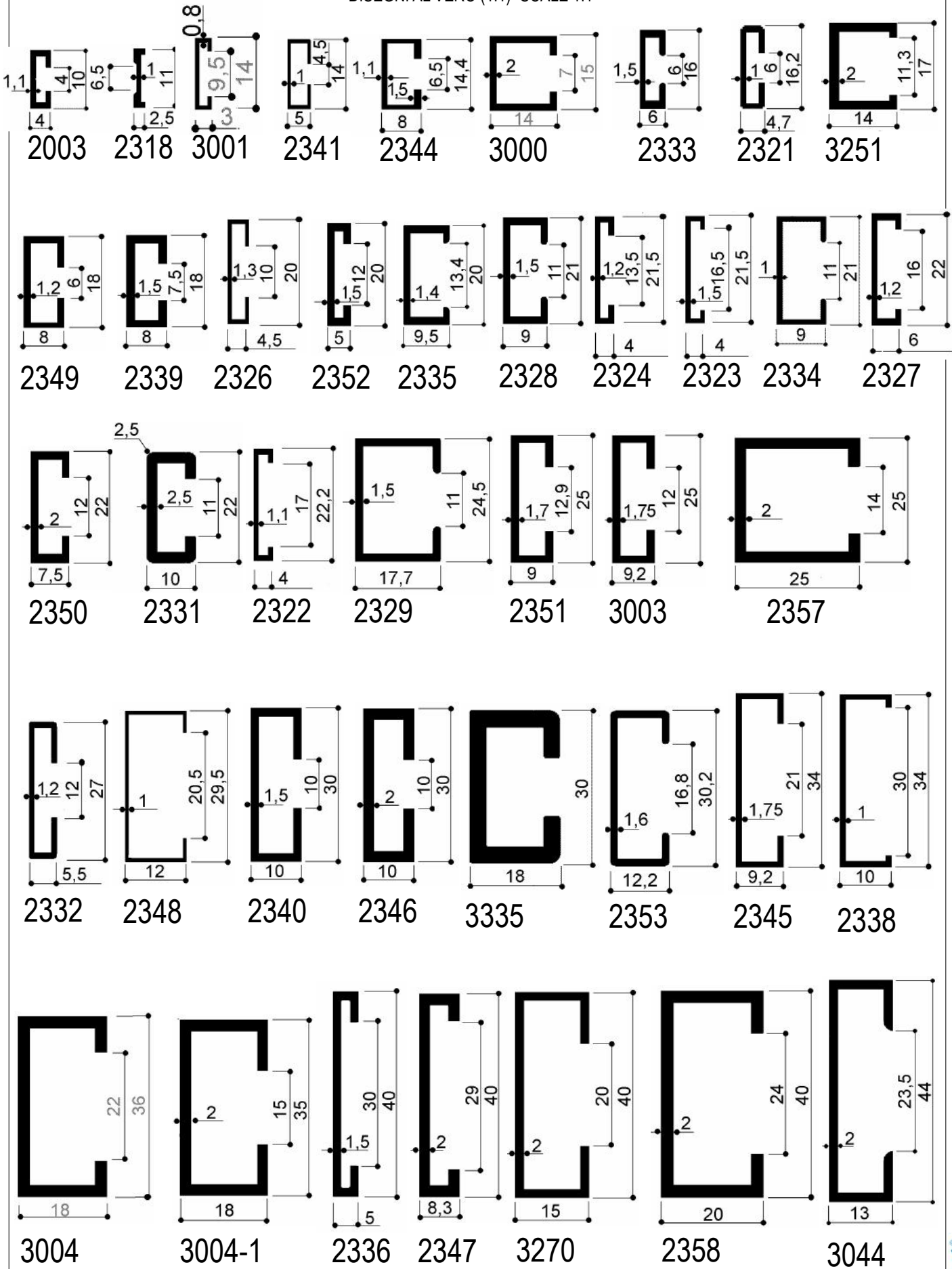

Via Newton, n.12

20016 Pero (Milano - Italy)

Tel. +39 02 3535955 r.a. Fax. +39 02 3539929

E-Mail: info@omar-alluminio.it

Cataloghi Online: www.omar-alluminio.it

www.omar-alluminio.com

PROFILATI ALLUMINIO A DISEGNO / STANDARD / SPECIALI / E PER:

ELETTRONICA / LED / FOTOVOLTAICO / AUTOMAZIONE ROBOTICA / PNEUMATICA / AUTOMOTIVE



Per ulteriori dimensioni di profili a C in alluminio consultare il sito: www.canalini-alluminio.it

-RIPRODUZIONE VIETATA-

AGGIORNAMENTO CONTINUO - ED. DEL 03-2023

Pag.117

Profili Speciali - Aluminium profile custom sections

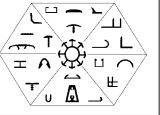

Via Newton, n.12
20016 Pero (Milano - Italy)
Tel. +39 02 3535955 r.a. Fax. +39 02 3539929
E-Mail: info@omar-alluminio.it

Cataloghi Online: www.omar-alluminio.it
www.omar-alluminio.com

PROFILATI ALLUMINIO A DISEGNO / STANDARD / SPECIALI / E PER:
ELETTRONICA / LED / FOTOVOLTAICO / AUTOMAZIONE ROBOTICA / PNEUMATICA / AUTOMOTIVE

DISEGNI AL VERO (1:1)

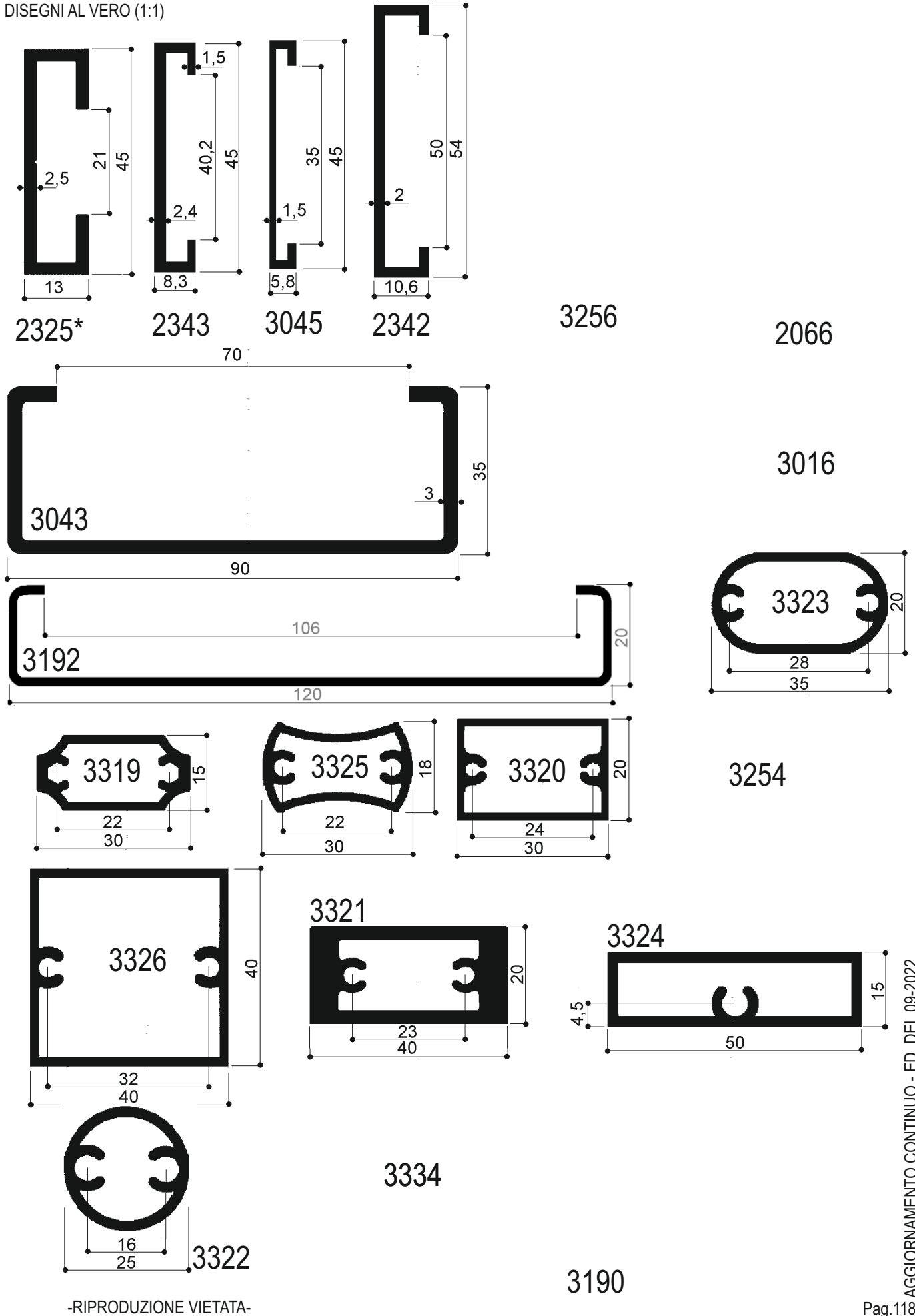

-RIPRODUZIONE VIETATA-



Profili Speciali - Aluminium profile custom sections



DISEGNI AL VERO (1:1)

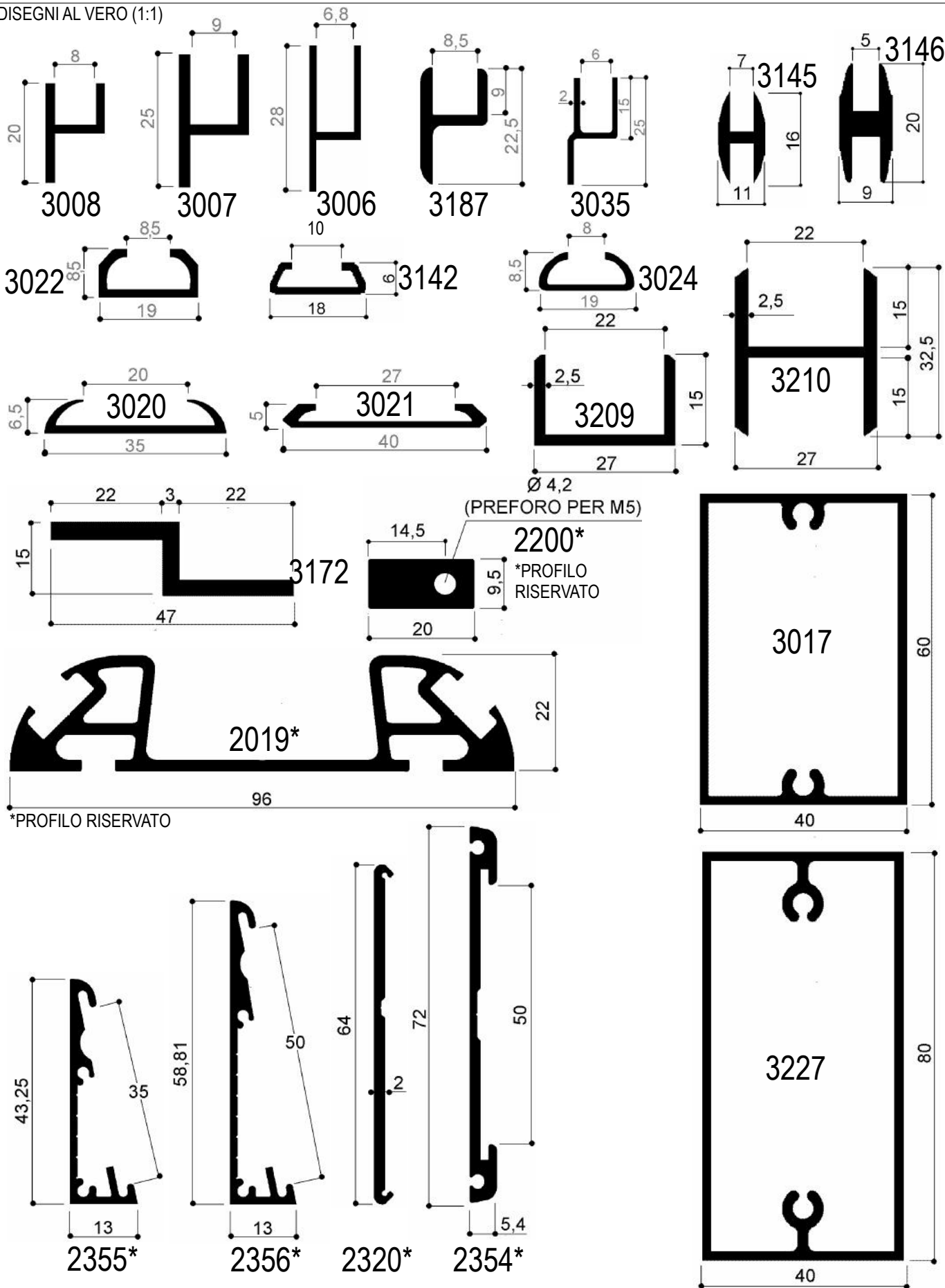

Via Newton, n.12

20016 Pero (Milano - Italy)

Tel. +39 02 3535955 r.a. Fax. +39 02 3539929

E-Mail: info@omar-alluminio.it

Cataloghi Online: www.omar-alluminio.it

www.omar-alluminio.com

PROFILATI ALLUMINIO A DISEGNO / STANDARD / SPECIALI / E PER:

ELETTRONICA / LED / FOTOVOLTAICO / AUTOMAZIONE ROBOTICA / PNEUMATICA / AUTOMOTIVE



Profili Speciali - RACLE -

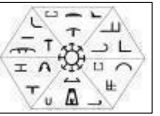

DISEGNI AL VERO (1:1)

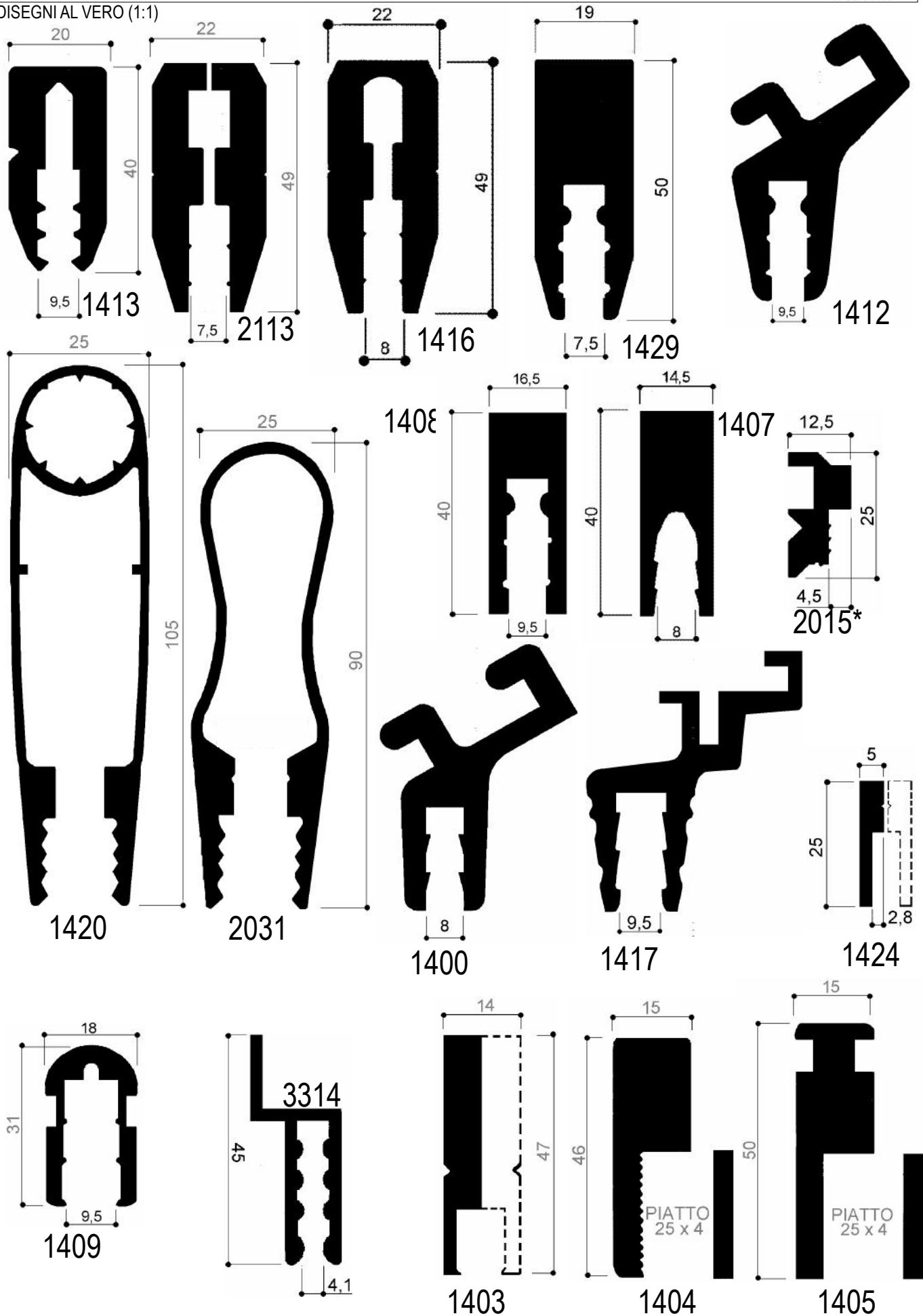

Cataloghi Online: www.omar-alluminio.it
www.omar-alluminio.com

Via Newton, n.12
 20016 Pero (Milano - Italy)
 Tel. +39 02 3535955 r.a. Fax. +39 02 3539929
 E-Mail: info@omar-alluminio.it

PROFILATI ALLUMINIO A DISEGNO / STANDARD / SPECIALI / E PER:
 ELETTRONICA / LED / FOTOVOLTAICO / AUTOMAZIONE ROBOTICA / PNEUMATICA / AUTOMOTIVE

OMAR s.p.a.
 PROFILATI ALLUMINIO
 ALTA TECNOLOGIA

Profili Speciali - RACLE -

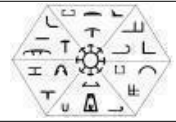

DISEGNI AL VERO (1:1)

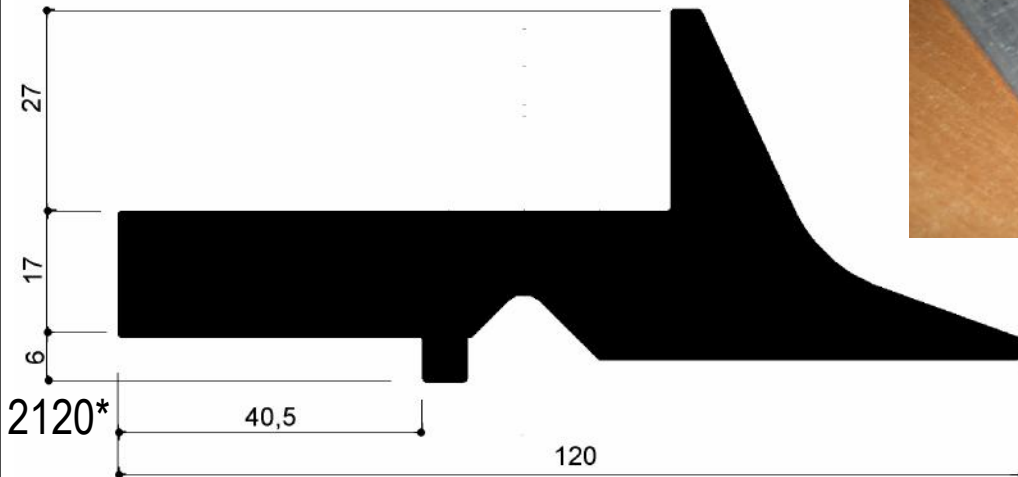
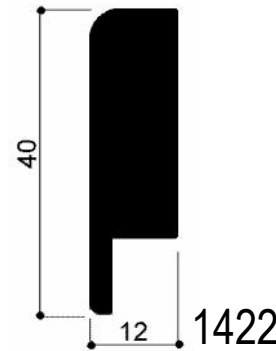
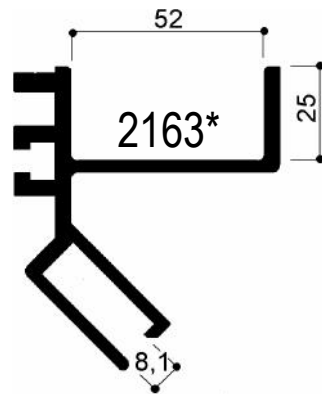
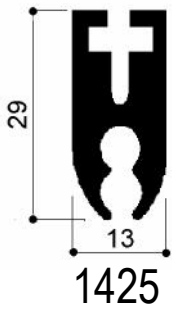
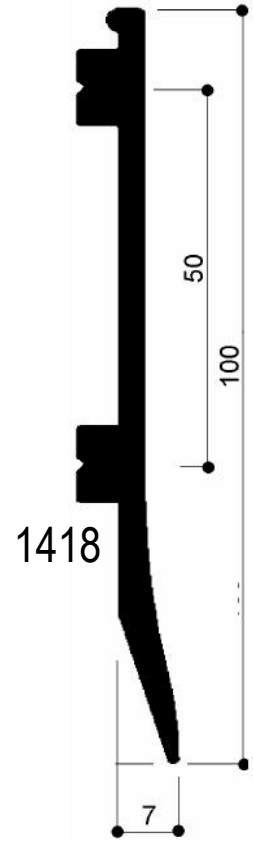
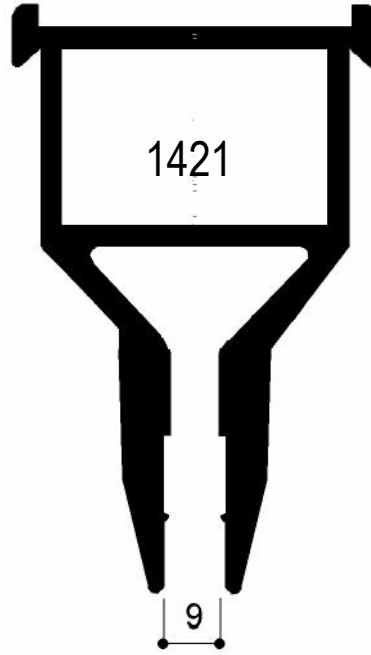
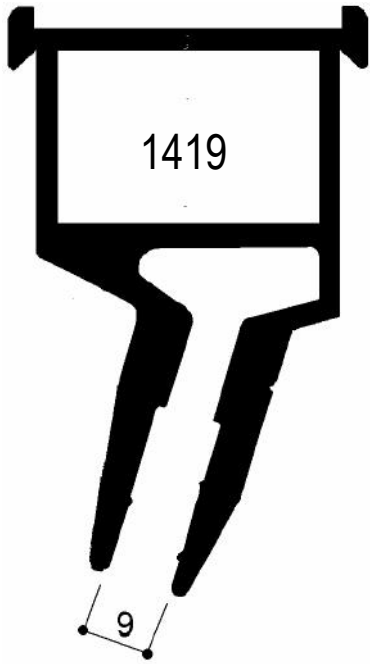

Via Newton, n.12
20016 Pero (Milano - Italy)
Tel. +39 02 3535955 r.a. Fax. +39 02 3539929
E-Mail: info@omar-alluminio.it

Cataloghi Online: www.omar-alluminio.it
www.omar-alluminio.com

PROFILATI ALLUMINIO A DISEGNO / STANDARD / SPECIALI / E PER:
ELETTRONICA / LED / FOTVOLTAICO / AUTOMAZIONE ROBOTICA / PNEUMATICA / AUTOMOTIVE



Profili Speciali - RACLE -



Via Newton, n. 12
20016 Pero (Milano - Italy)
Tel. +39 02 3535955 r.a. Fax. +39 02 3539929
E. Mail: info@omar-alluminio.it

Cataloghi Online: www.omar-alluminio.it
www.omar-alluminio.com

PROFILATI ALLUMINIO A DISEGNO / STANDARD / SPECIALI / E PER:
ELETTRONICA / LED / FOTOVOLTAICO / AUTOMAZIONE ROBOTICA / PNEUMATICA / AUTOMOTIVE



FOTO DI ESEMPIO: PROFILI ESTRUSI IN ALLUMINIO PORTA RACLE DA STAMPA A QUADRO SERIGRAFICA PER:
-MANOMACCHINE: REGGIANI, MECCANOTESSILE, BUSER etc...
-A CARRELLO: GALY, VIERO, ROBUSTELLI etc...
-PER IL SETTORE SERIGRAFICO: SIASPRINT, ARGON, THIEME etc..
-A GIOSTRA SERIGRAFICA: TEK-IND

RACLA

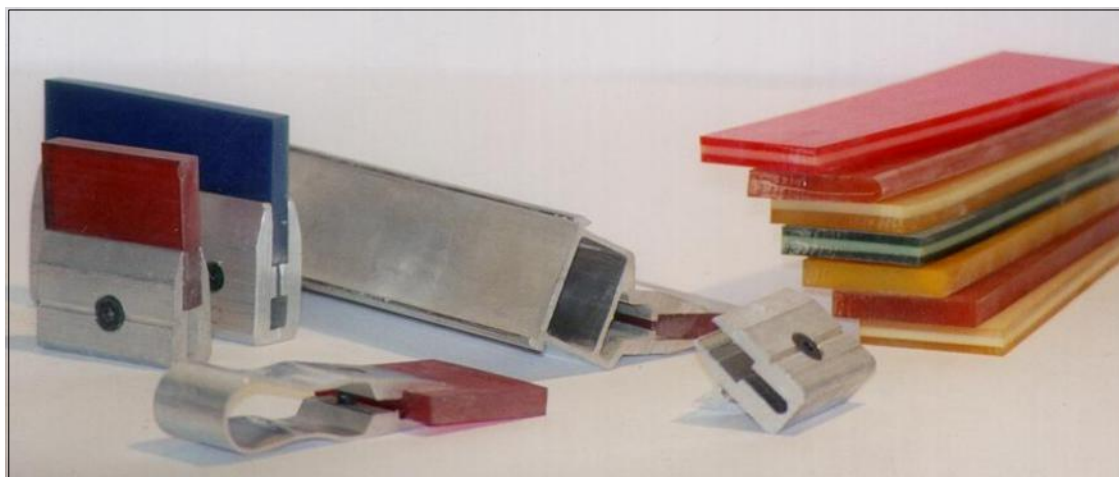

2113 LUNGHEZZA BARRE MT 4 CON
VITI A TESTA CILINDRICA M5 QUOTA PURAMENTE
INDICATIVA DEL PASSO VITI: 80MM CIRCA
(TOLLERANZA +/-5MM)

RACLA MECCANICA



1413 / 1419 / 1421 / 1429 LUNGHEZZA BARRE MT 4 CON
VITI A TESTA SVASATA M6 QUOTA PURAMENTE INDICATIVA DEL
PASSO VITI: 100MM CIRCA (TOLLERANZA +/-5MM)

RACLA A MANO



2031 LUNGHEZZA BARRE
MT 4 CON VITI A TESTA
SVASATA M6 QUOTA PURAMENTE
INDICATIVA DEL PASSO
VITI: 100 MM CIRCA
(TOLLERANZA +/-5MM)



Profili Speciali - STADIE/STAGGE



DISEGNI META' DEL VERO (1:2)- SCALE 1:2

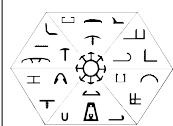
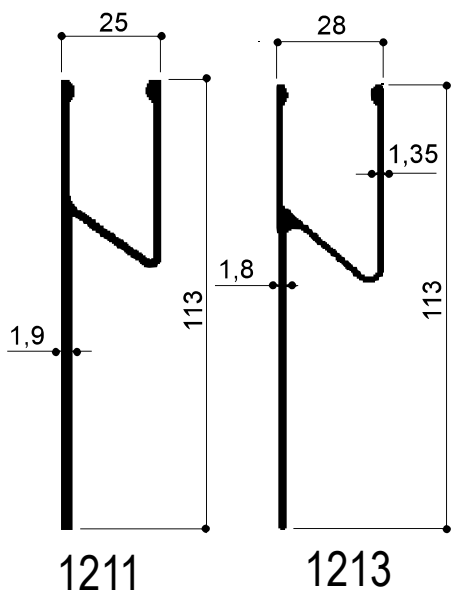
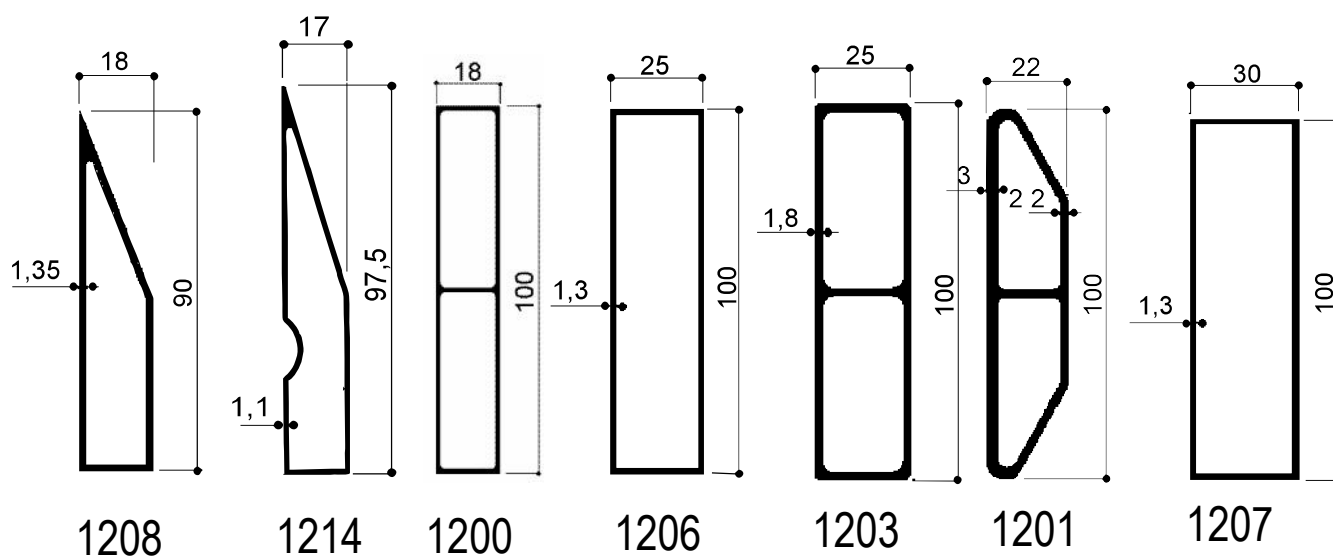
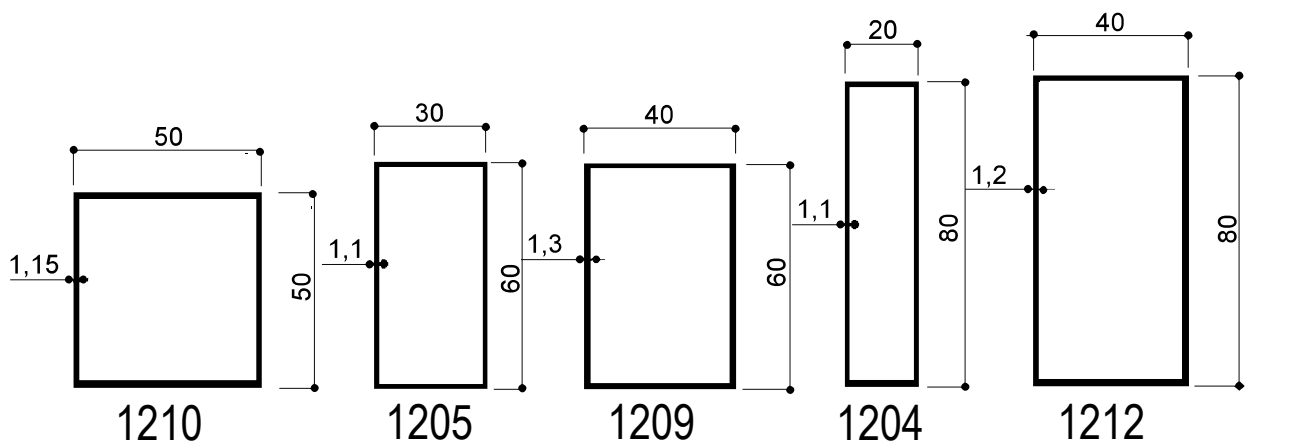

ANCHE PER MODESTE QUANTITA' SI POSSONO FORNIRE
PREVIO ALLESTIMENTO MATRICE, ULTERIORI PROFILI
SECONDO LE VS. SPECIFICHE

Via Newton, n.12
20016 Pero (Milano - Italy)
Tel. +39 02 3535955 r.a. Fax. +39 02 3539929
E-Mail: info@omar-alluminio.it

Cataloghi Online: www.omar-alluminio.it
www.omar-alluminio.com

PROFILATI ALLUMINIO A DISEGNO / STANDARD / SPECIALI / E PER:
ELETTRONICA / LED / FOTOVOLTAICO / AUTOMAZIONE ROBOTICA / PNEUMATICA / AUTOMOTIVE



Profili Speciali - Cantieri Nautici -



DISEGNI AL VERO (1:1)- SCALE 1:1
PLASTICA IN ROTOLI DA MT.30

Via Newton, n.12
20016 Pero (Milano - Italy)
Tel. +39 02 3535955 r.a. Fax. +39 02 3539929
E-Mail: info@omar-alluminio.it

Cataloghi Online: www.omar-alluminio.it
www.omar-alluminio.com

PROFILATI ALLUMINIO A DISEGNO / STANDARD / SPECIALI / E PER:
ELETTRONICA / LED / FOTOVOLTAICO / AUTOMAZIONE ROBOTICA / PNEUMATICA / AUTOMOTIVE

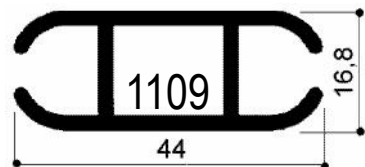
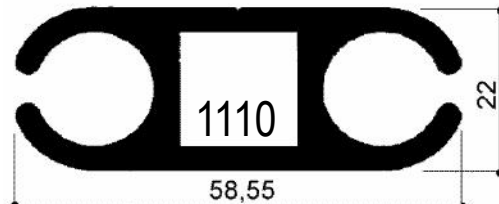
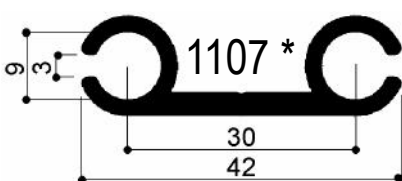
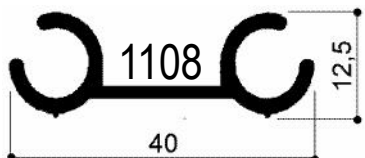
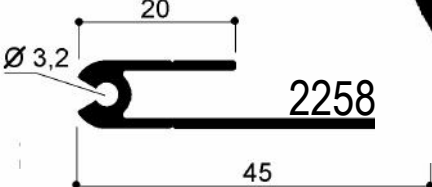
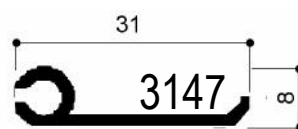
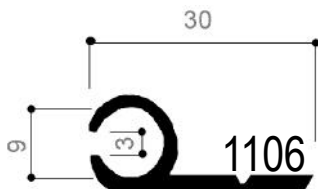
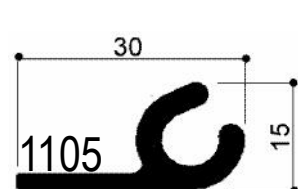
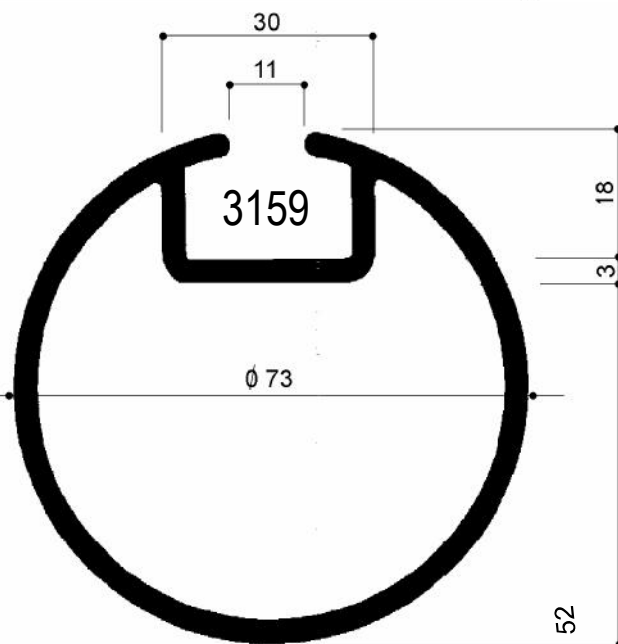
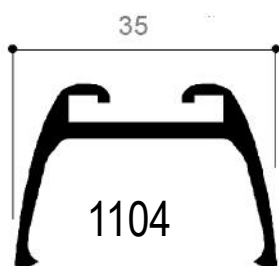
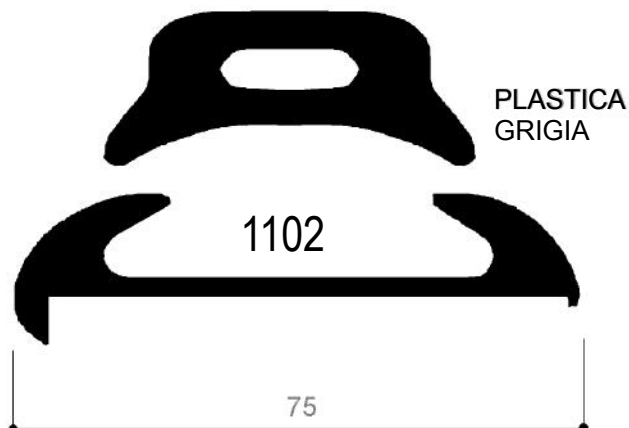
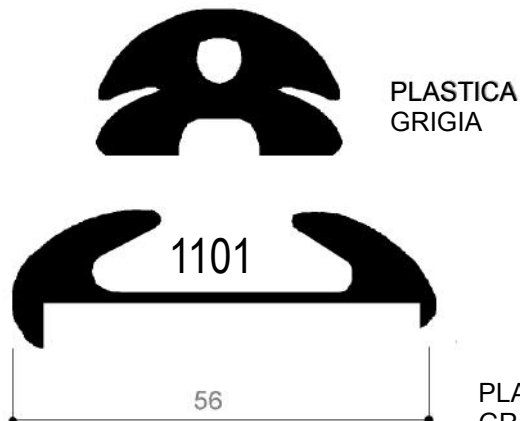
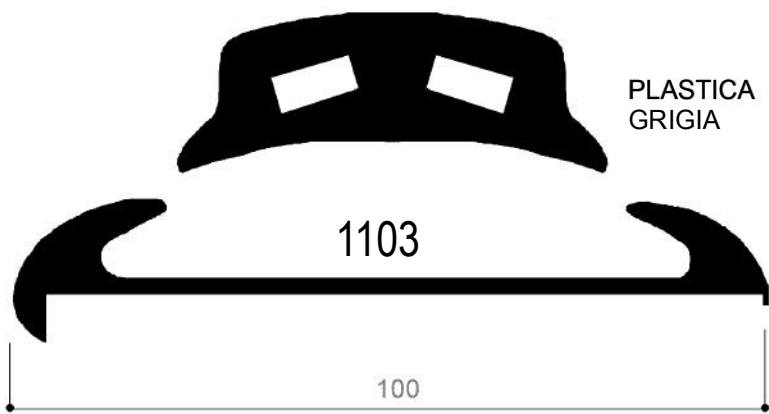
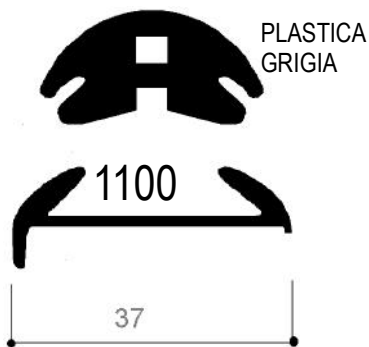

Profili Speciali - BATTISCOPIA -



DISEGNI META' DEL VERO (1:2)- SCALE 1:2

3090 OX. SATINATO
CHIMICO NATURALE

3092 OX SATINATO
CHIMICO NATURALE

3093 ESEMPIO
DI MONTAGGIO

2012* ESEMPIO
DI MONTAGGIO

*PROFILO RISERVATO

3087 OX
SATINATO CHIMICO NATURALE

3088 ESEMPIO
DI MONTAGGIO

3085 OX SATINATO CHIMICO NATURALE

3086 ESEMPIO
DI MONTAGGIO

3271 ESEMPIO
DI MONTAGGIO

3272 OX SATINATO
CHIMICO NATURALE

3083 OX SATINATO
CHIMICO NATURALE

3084 OX SATINATO
CHIMICO NATURALE

ESEMPIO
DI MONTAGGIO

3089

3234

3235

3236

3308 ESEMPIO
DI MONTAGGIO

3309

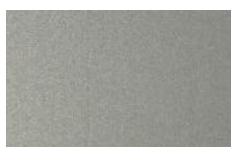

FINITURA STANDARD PRONTA A STOCK PER TUTTI I PROFILI ILLUSTRATI: OX SATINATO CHIMICO NATURALE

Via Newton, n.12
20016 Pero (Milano - Italy)
Tel. +39 02 3535955 r.a. Fax. +39 02 3539929
E-Mail: info@omar-alluminio.it

Cataloghi Online: www.omar-alluminio.it
www.omar-alluminio.com
PROFILATI ALLUMINIO A DISEGNO / STANDARD / SPECIALI / E PER:
ELETTRONICA / LED / FOTOVOLTAICO / AUTOMAZIONE ROBOTICA / PNEUMATICA / AUTOMOTIVE



Profili Speciali - BATTISCOPIA -



Via Newton, n.12
20016 Pero (Milano - Italy)
Tel. +39 02 3535955 r.a. Fax. +39 02 3539929
E-Mail: info@omar-alluminio.it

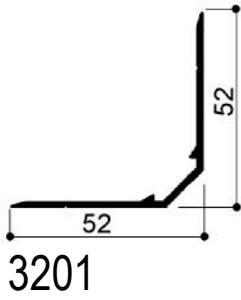

3201

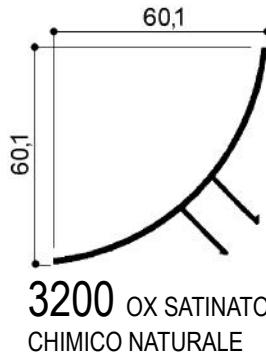

3200 OX SATINATO
CHIMICO NATURALE

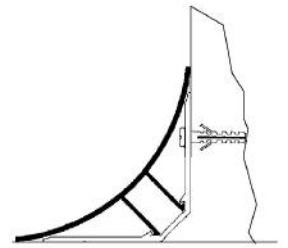

ESEMPIO
DI MONTAGGIO

ACCESSORI

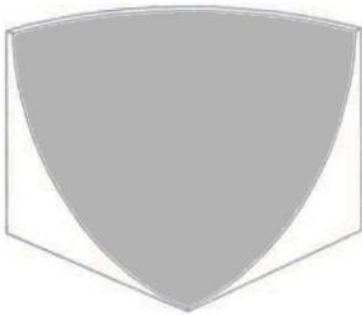

B-0001

FUSIONE IN ALLUMINIO 1/8 DI SFERA
VERNICIATO NATURALE PER
GIUNZIONE ANGOLARE DEI PROFILI 3200 / 3201

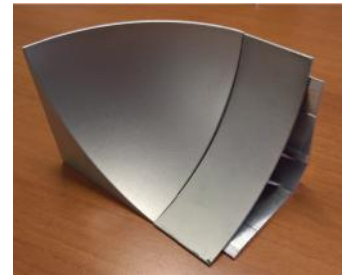

ESEMPIO DI MONTAGGIO



B-0002

FUSIONE IN ALLUMINIO 1/4 DI SFERA
VERNICIATO NATURALE PER GIUNZIONE
ANGOLARE DEI PROFILI 3200 / 3201

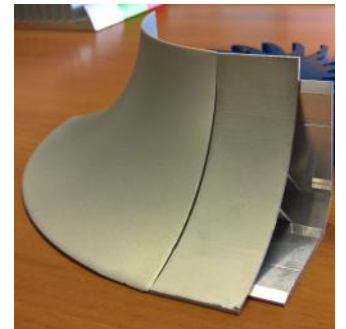

ESEMPIO DI MONTAGGIO



B-0003

FUSIONE IN ALLUMINIO TAPPO TERMINALE
VERNICIATO NATURALE PER I PROFILI 3200 / 3201



ESEMPIO DI MONTAGGIO

Cataloghi Online: www.omar-alluminio.it
www.omar-alluminio.com

PROFILATI ALLUMINIO A DISEGNO / STANDARD / SPECIALI / E PER:
ELETTRONICA / LED / FOTOVOLTAICO / AUTOMAZIONE ROBOTICA / PNEUMATICA / AUTOMOTIVE

OMAR s.r.l.
PROFILATI ALLUMINIO
ALTA TECNOLOGIA

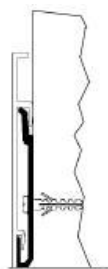
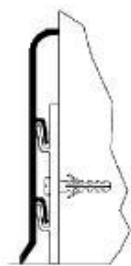
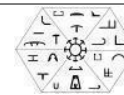

Via Newton, n.12
20016 Pero (Milano - Italy)
Tel. +39 02 3535955 r.a. Fax. +39 02 3539929
E-Mail: info@omar-alluminio.it

ELENCO FINITURE DISPONIBILI SU RICHIESTA

FINITURA: ANODIZZATO

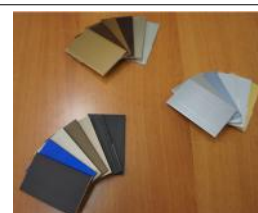

ELETTROCOLORE BRONZO 15	ELETTROCOLORE BRONZO 16	ELETTROCOLORE BRONZO 17	ELETTROCOLORE BRONZO 18	ELETTROCOLORE BRONZO 19	ELETTROCOLORE BRONZO 20
ELETTROCOLORE COD.1	ELETTROCOLORE COD.2	ELETTROCOLORE COD.3	ELETTROCOLORE COD.4	ELETTROCOLORE COD.5	ELETTROCOLORE COD.6
BLU COBALTO	ORO	ARGENTO SPAZZOLATO	ARGENTO CHIMICO FINITURA STANDARD DISPONIBILE 'DAL PRONTO'	FUME'	ACCIAIO
TITANIO LUCIDO					

FINITURA: VERNICIATO

COD.K06	COD.K09	COD.K17	COD.K20	COD.K23	COD.K31
COD.K35	COD.K38	COD.K40			

Cataloghi Online: www.omar-alluminio.it
www.omar-alluminio.com

PROFILATI ALLUMINIO A DISEGNO / STANDARD / SPECIALI / E PER:
ELETTRONICA / LED / FOTVOLTAICO / AUTOMAZIONE ROBOTICA / PNEUMATICA / AUTOMOTIVE



Profili Speciali - TENDE PER INTERNI

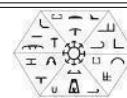

DISEGNI AL VERO (1:1)

Via Newton, n.12
20016 Pero (Milano - Italy)
Tel. +39 02 3535955 r.a. Fax. +39 02 3539929
E-Mail: info@omar-alluminio.it

Cataloghi Online: www.omar-alluminio.it
www.omar-alluminio.com

PROFILATI ALLUMINIO A DISEGNO / STANDARD / SPECIALI / E PER:
ELETTRONICA / LED / FOTOVOLTAICO / AUTOMAZIONE ROBOTICA / PNEUMATICA / AUTOMOTIVE

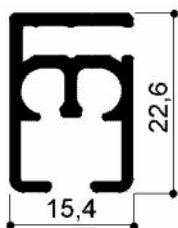
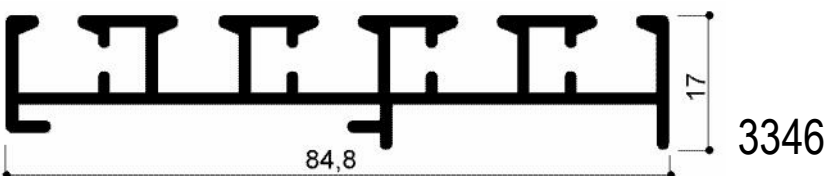
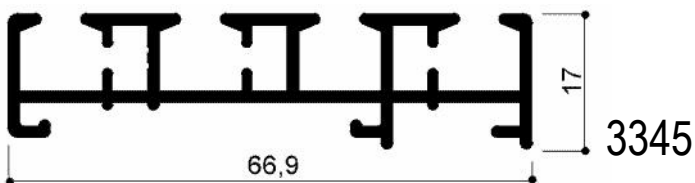
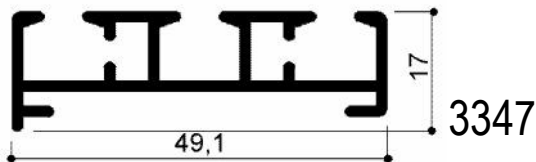
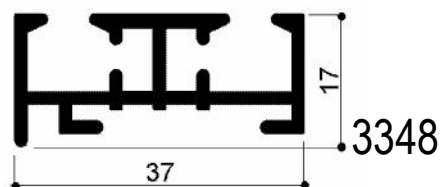

3344

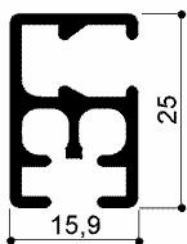

3343

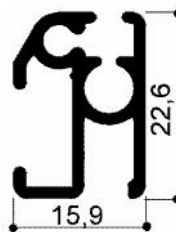

3342

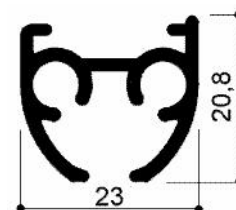

3341

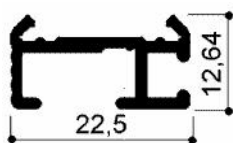

3349
VELCRATO

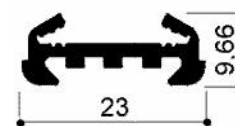

3350
VELCRATO

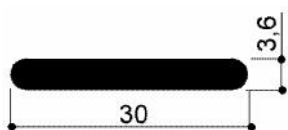

PR30x3,6x1,8

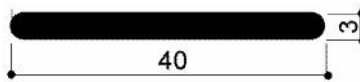

PR40x3x1,5

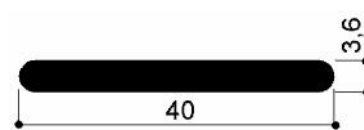

PR40x3,6x1,8

Profili Speciali - TENDE PER INTERNI



DISEGNI AL VERO (1:1)

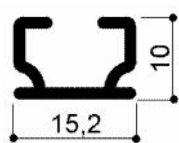
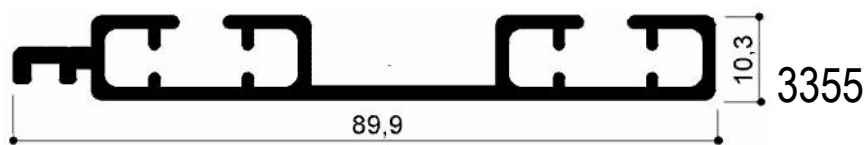

3351

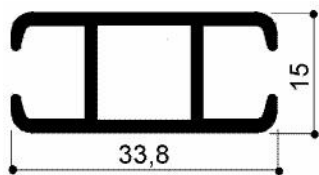

3354

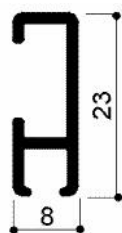

3358

VELCRATO

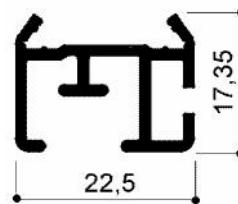

3359

VELCRATO

Cataloghi Online: www.omar-alluminio.it
www.omar-alluminio.com

PROFILATI ALLUMINIO A DISEGNO / STANDARD / SPECIALI / E PER:
ELETTRONICA / LED / FOTOVOLTAICO / AUTOMAZIONE ROBOTICA / PNEUMATICA / AUTOMOTIVE

Via Newton, n.12
20016 Pero (Milano - Italy)
Tel. +39 02 3535955 r.a. Fax. +39 02 3539929
E-Mail: info@omar-alluminio.it



Profili Speciali - ARREDO URBANO

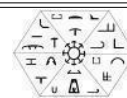

Via Newton, n.12
20016 Pero (Milano - Italy)
Tel. +39 02 3535955 r.a. Fax. +39 02 3539929
E-Mail: info@omar-alluminio.it

Cataloghi Online: www.omar-alluminio.it
www.omar-alluminio.com

PROFILATI ALLUMINIO A DISEGNO / STANDARD / SPECIALI / E PER:
ELETTRONICA / LED / FOTOVOLTAICO / AUTOMAZIONE ROBOTICA / PNEUMATICA / AUTOMOTIVE

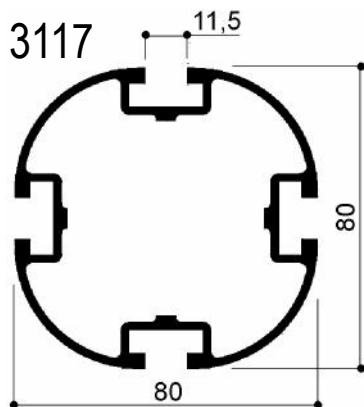

DISEGNI META' DEL VERO (1:2)- SCALE 1:2

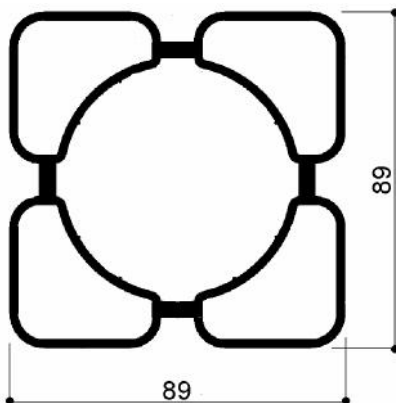
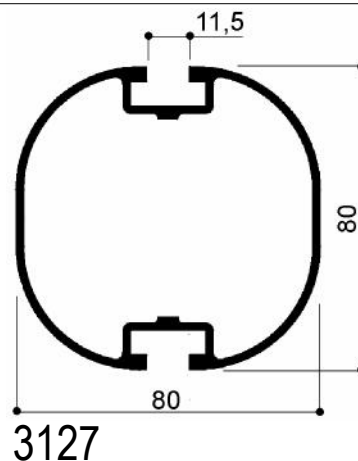
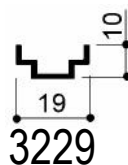

PROFILO RISERVATO

-RIPRODUZIONE VIETATA-

Profili Speciali - Soglie -

DISEGNI AL VERO (1:1)- SCALE 1:1

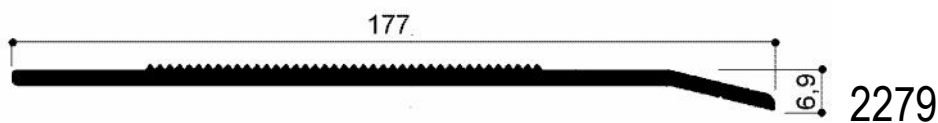

DISEGNI META' DEL VERO (1:2)- SCALE 1:2

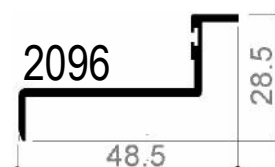
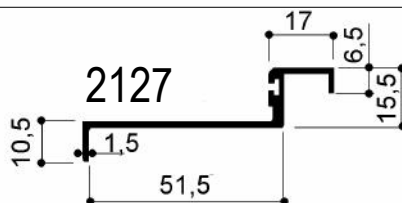
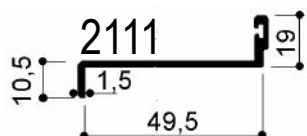

DISEGNI AL VERO (1:1)- SCALE 1:1

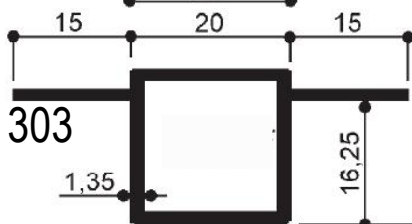
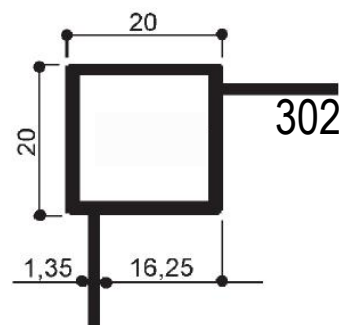
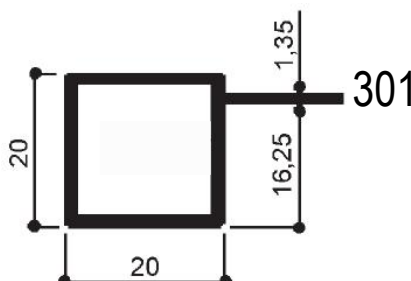
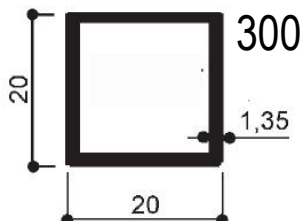



FOTO DI ESEMPIO: PROFILI IN ALLUMINIO ESTRUSO PIATTI DI GRANDI DIMENSIONI
LEGA 6060 - 6082



FOTO DI ESEMPIO: PROFILI IN ALLUMINIO ESTRUSO
CANNE PER LA REALIZZAZIONE DI CILINDRI PNEUMATICI

Consultate il catalogo aggiornato online su:

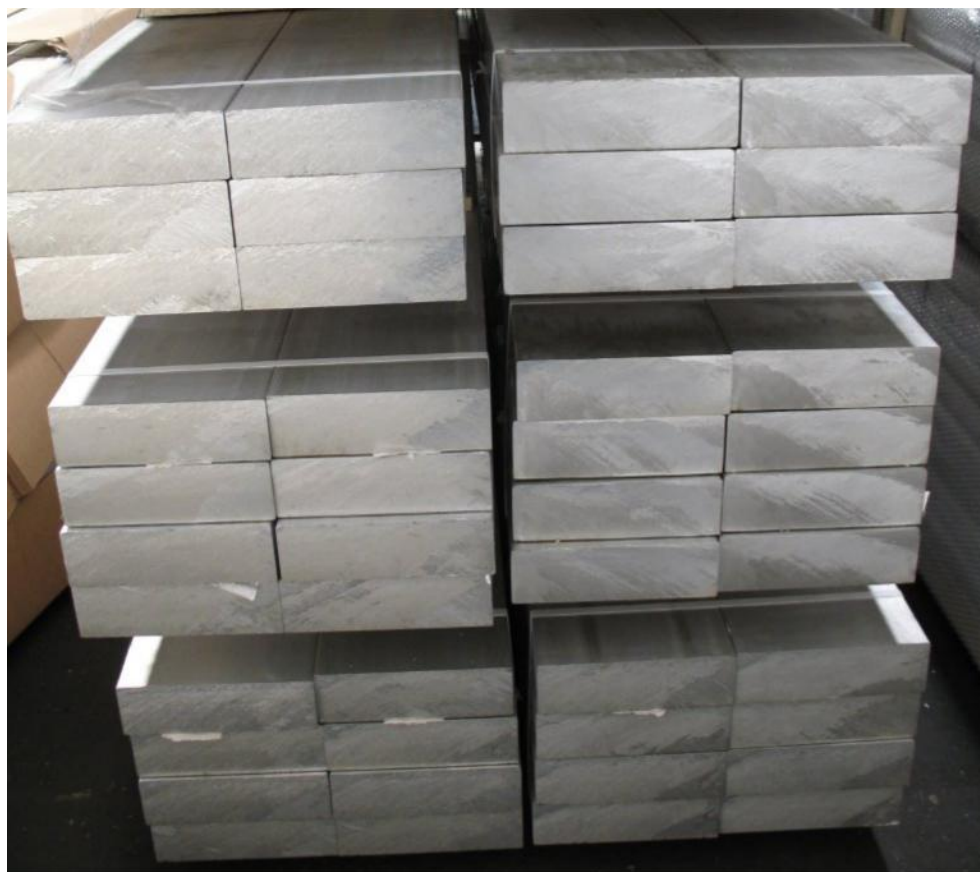
www.omar-alluminio.it

www.omar-alluminio.com

www.angolari-alluminio.it

www.canalini-alluminio.it

www.coprigiunti-alluminio.biz

www.fermavetro.biz

www.fermapassatoie.com

www.microprofili-alluminio.it

www.piatti-alluminio.it

www.piatti-trafilati-alluminio.biz

www.profilati-h-alluminio.it

www.profilati-omega-alluminio.it

www.profilati-t-alluminio.it

www.profilati-z-alluminio.it

www.semitondi-alluminio.biz

www.travi-alluminio.eu

www.tubi-alluminio.it

www.unghietta-alluminio.biz

Via Newton, n.12

20016 Pero (Milano - Italy)

Tel. +39 02 3535955 r.a. Fax. +39 02 3539929

E-Mail: info@omar-alluminio.it

Cataloghi Online: www.omar-alluminio.it

www.omar-alluminio.com

PROFILATI ALLUMINIO A DISEGNO / STANDARD / SPECIALI / E PER:

ELETTRONICA / LED / FOTOVOLTAICO / AUTOMAZIONE ROBOTICA / PNEUMATICA / AUTOMOTIVE

ACCESSORI per contenitori porta schede elettroniche tipo DIN 43700

-DISEGNI PROFILI vedi pag. 1 -



Via Newton, n.12
20016 Pero (Milano - Italy)
Tel. +39 02 3535955 r.a. Fax. +39 02 3539929
E.Mail: info@omar-alluminio.it

Cataloghi Online: www.omar-alluminio.it
www.omar-alluminio.com

PROFILATI ALLUMINIO A DISEGNO / STANDARD / SPECIALI / E PER:
ELETTRONICA / LED / FOTOVOLTAICO / AUTOMAZIONE ROBOTICA / PNEUMATICA / AUTOMOTIVE

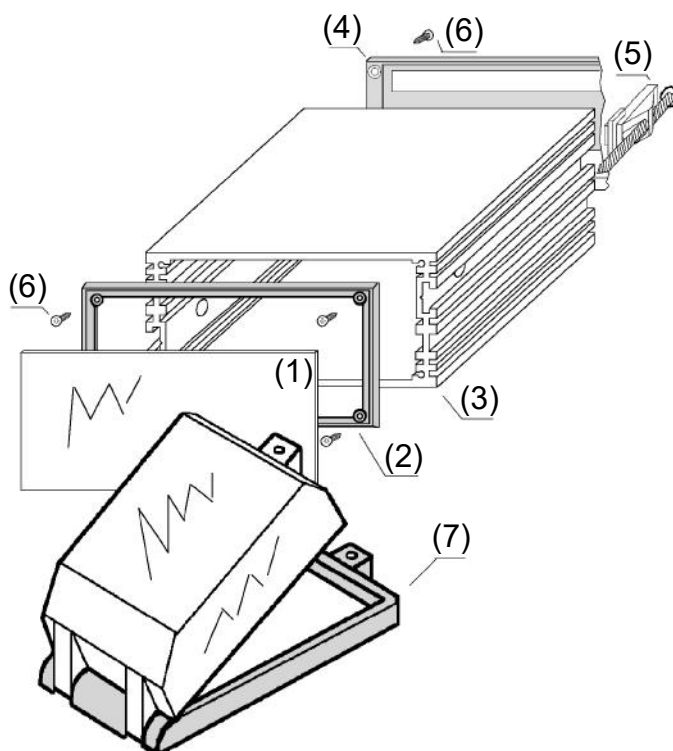

(1) PANNELLO ANTERIORE IN ALLUMINIO TUTTO CHIUSO SPESSORE 15/10 OSSIDATO ARGENTO CON 'PELABILE'. PRONTO PER EVENTUALI PERSONALIZZAZIONI CON FORATURE "CUSTOM" ED EVENTUALE SERIGRAFIA

(2) CORNICE ANTERIORE COLORE NERO IN NYLON6 - FIBRA VETRO 30%

(3) CORPO CONTENITORE IN ALLUMINIO CON PROFONDITA' LIBERA. DISPONIBILE CON DIFFERENTI TRATTAMENTI SUPERFICIALI (OSSIDAZIONE: NERA, NATURALE, ROSSO, BLU, VERDE ETC.). SONO POSSIBILI LAVORAZIONI MECCANICHE (FORI, TAGLI, FRESATURE)

(4) FONDELLO POSTERIORE COLORE NERO IN NYLON 6 - FIBRA VETRO 30%
FORNIBILE IN DIVERSE SOLUZIONI (FONDELLO APERTO, CHIUSO, 1/2 APERTO, CON FESSURE A STRAPPO)

(5) AGGANCI DI FISSAGGIO IN MATERIALE PLASTICO NERO PER MONTAGGIO A PANNELLO

(6) VITI AUTOFILETTANTI BRUNITE PER FISSAGGIO CORNICI O PANNELLI IN ALLUMINIO

(7) PROTEZIONE ANTISPRUZZO IN POLICARBONATO TRASPARENTE

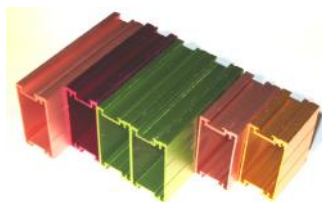

ACCESSORI per contenitori porta schede elettroniche tipo DIN 43700

-DISEGNI PROFILI vedi pag. 1 -



DISEGNI META' DEL VERO (1:2)

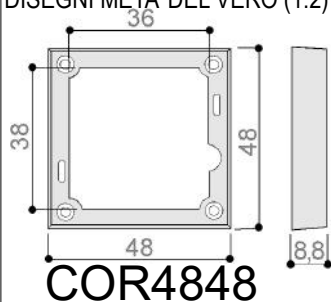

COR4848

COR4848: Cornice anteriore nera

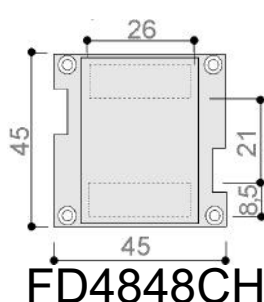

FD4848CH

FD4848CH: Fondello posteriore chiuso (con inserti per connettori a 'strappo') -

FD4848AP: Fondello posteriore aperto

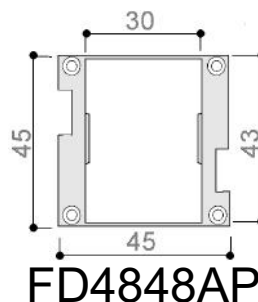

FD4848AP

DISEGNI META' DEL VERO (1:2)-

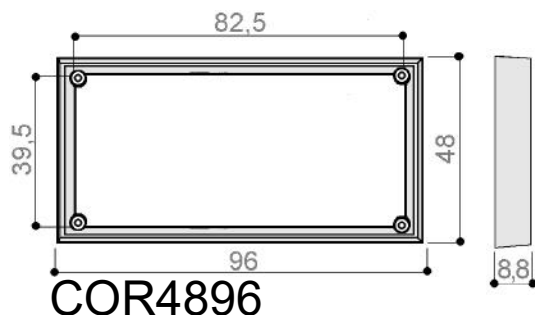

COR4896

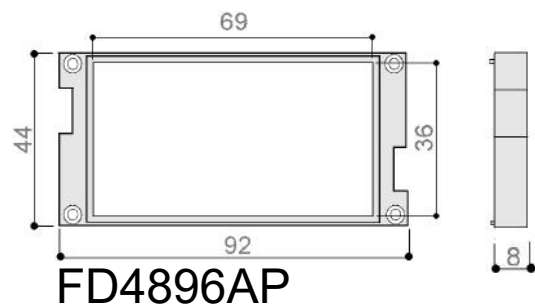

FD4896AP

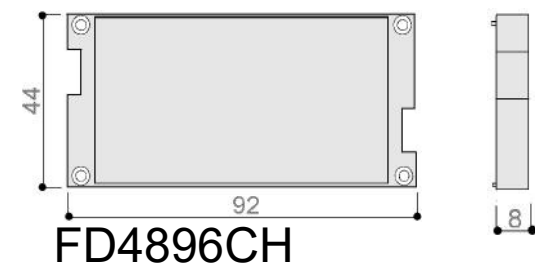

FD4896CH

COR4896: Cornice anteriore nera
FD4896CH: Fondello posteriore chiuso
FD4896AP: Fondello posteriore aperto

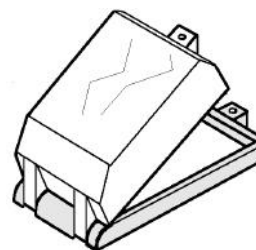

COP4896

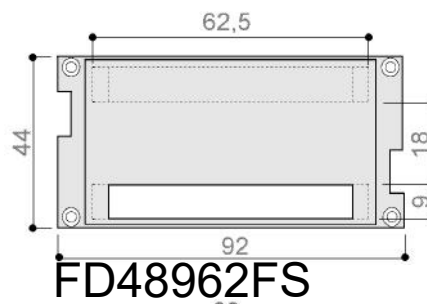

FD48962FS

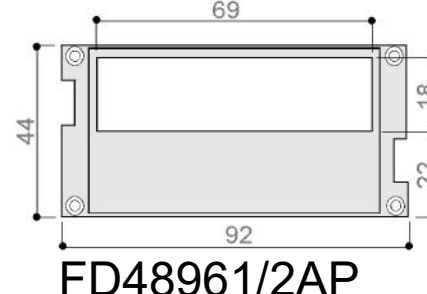

FD48961/2AP

FD48961/2AP: Fondello posteriore mezzo aperto -
FD48962FS: Fondello posteriore con 2 fessure a strappo
COP4896: Copertura anteriore trasparente antispruzzo

Via Newton, n.12
20016 Pero (Milano - Italy)
Tel. +39 02 3535955 r.a. Fax. +39 02 3539929
E-Mail: info@omar-alluminio.it

Cataloghi Online: www.omar-alluminio.it
www.omar-alluminio.com

PROFILATI ALLUMINIO A DISEGNO / STANDARD / SPECIALI / E PER:
ELETTRONICA / LED / FOTOVOLTAICO / AUTOMAZIONE ROBOTICA / PNEUMATICA / AUTOMOTIVE



ACCESSORI per contenitori porta schede elettroniche tipo DIN 43700

-DISEGNI PROFILI vedi pag. 1



Via Newton, n.12
20016 Pero (Milano - Italy)
Tel. +39 02 3535955 r.a. Fax. +39 02 3539929
E-Mail: info@omar-alluminio.it

Cataloghi Online: www.omar-alluminio.it
www.omar-alluminio.com
PROFILATI ALLUMINIO A DISEGNO / STANDARD / SPECIALI / E PER:
ELETTRONICA / LED / FOTOVOLTAICO / AUTOMAZIONE ROBOTICA / PNEUMATICA / AUTOMOTIVE

DISEGNI META' DEL VERO (1:2)

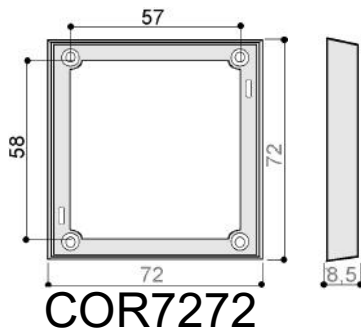

COR7272

COR7272: Cornice anteriore nera
FD7272AP: Fondello posteriore aperto

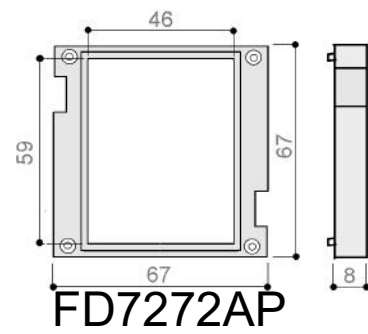

FD7272AP

DISEGNI META' DEL VERO (1:2)

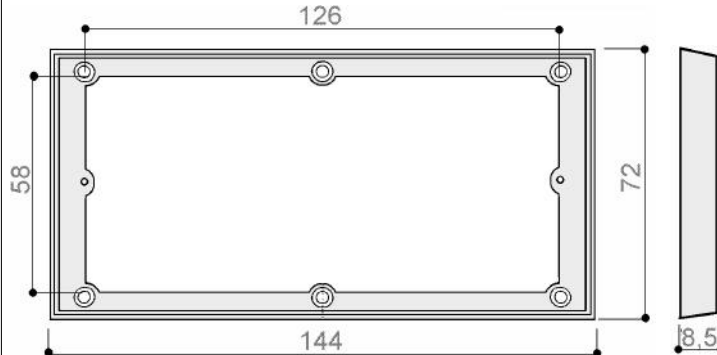

COR72144

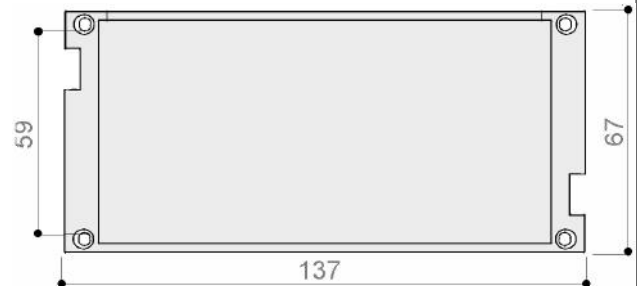

FD72144CH

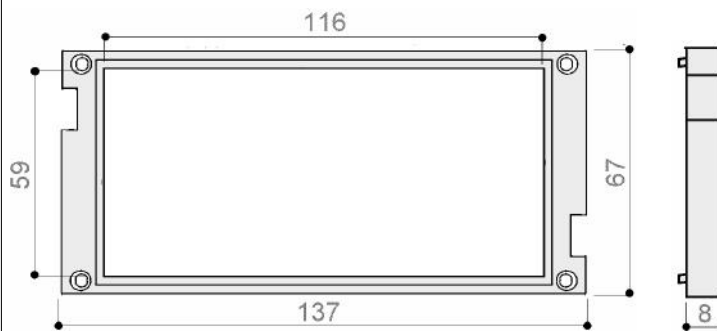

FD72144AP

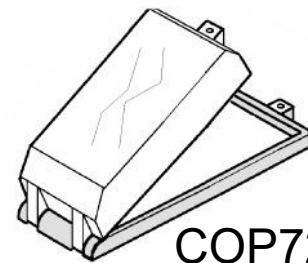

COP72144

COR72144: Cornice anteriore nera
FD72144AP: Fondello posteriore aperto

FD72144CH: Fondello posteriore chiuso
COP72144: Copertura anteriore trasparente
antispruzzo

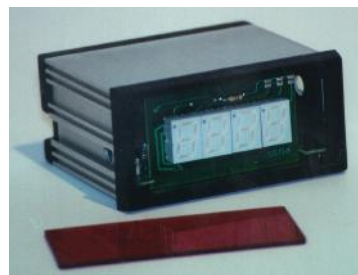

ACCESSORI per contenitori porta schede elettroniche tipo DIN 43700

-DISEGNI PROFILI vedi pag. 1 -

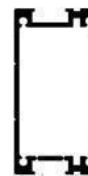

DISEGNI META' DEL VERO (1:2)

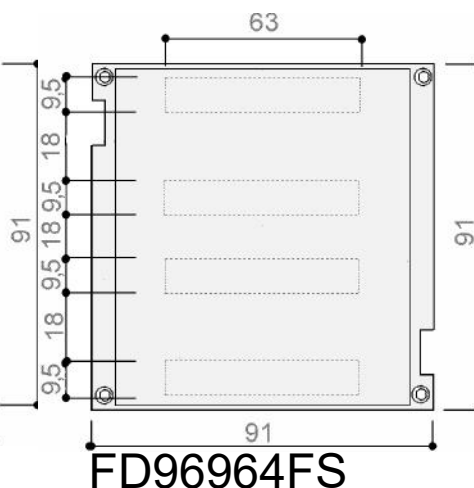
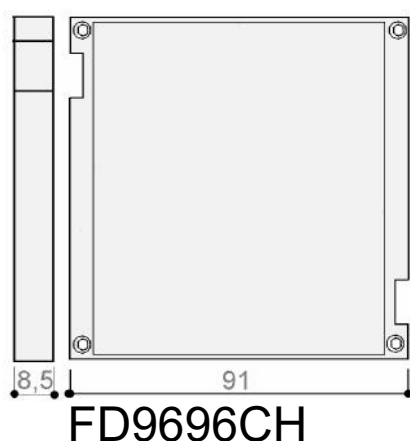
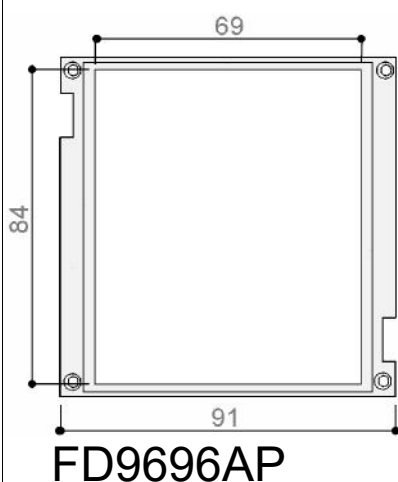
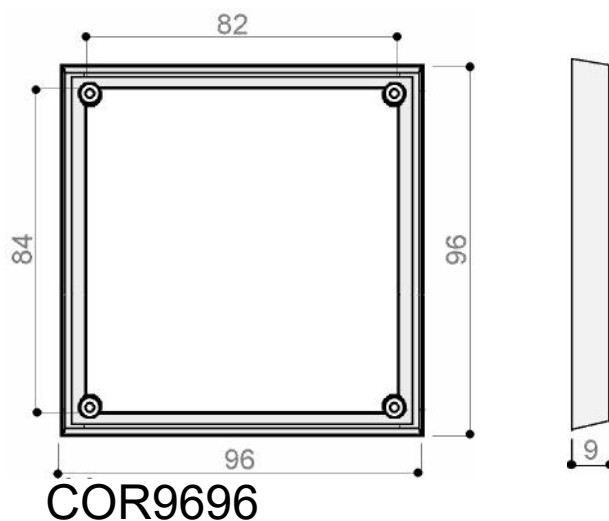

COR9696: Cornice anteriore nera
 FD9696AP: Fondello posteriore aperto
 FD9696CH: Fondello posteriore chiuso
 FD96964FS: Fondello posteriore con 4 fessure

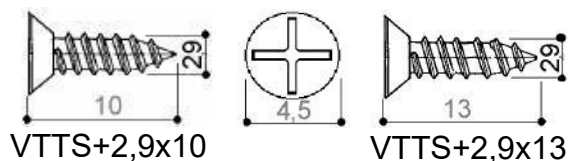

Viti autofilettanti speciali con testa a diametro ridotto e taglio a croce.
 Adatte al fissaggio delle cornici e dei fondelli -

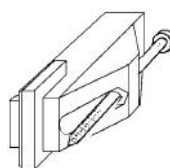

Tassello brevettato in plastica per il fissaggio al pannello -

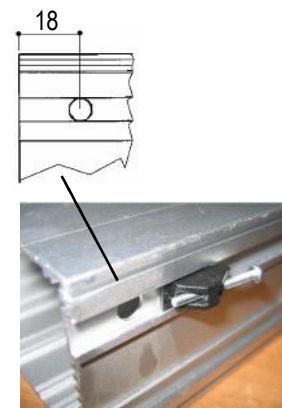

Cataloghi Online: www.omar-alluminio.it

www.omar-alluminio.com

PROFILATI ALLUMINIO A DISEGNO / STANDARD / SPECIALI / E PER:

ELETTRONICA / LED / FOTOVOLTAICO / AUTOMAZIONE ROBOTICA / PNEUMATICA / AUTOMOTIVE



Via Newton, n.12

20016 Pero (Milano - Italy)

Tel. +39 02 3535955 r.a. Fax. +39 02 3539929

E-Mail: info@omar-alluminio.it

ACCESSORI per contenitori porta schede elettroniche tipo DIN 43700

-DISEGNI PROFILI vedi pag. 1



DISEGNI META' DEL VERO (1:2)

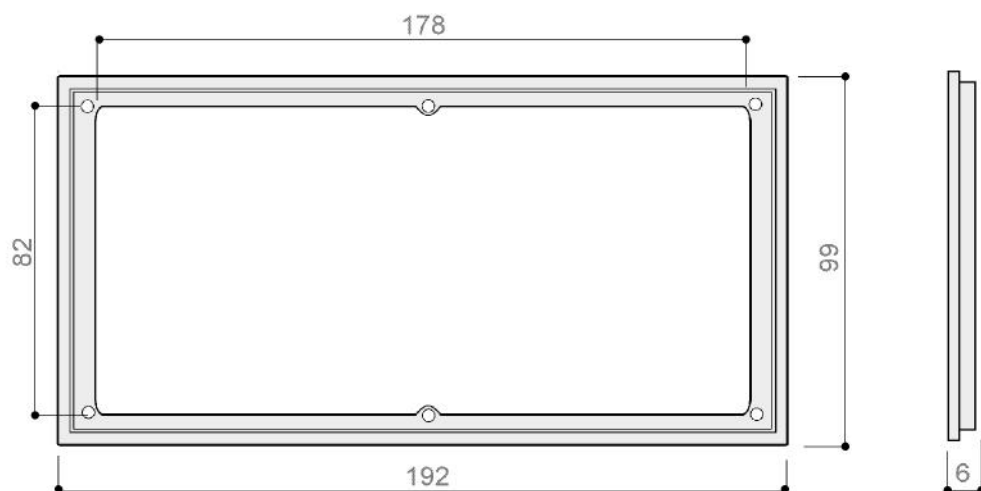

SUPP96192

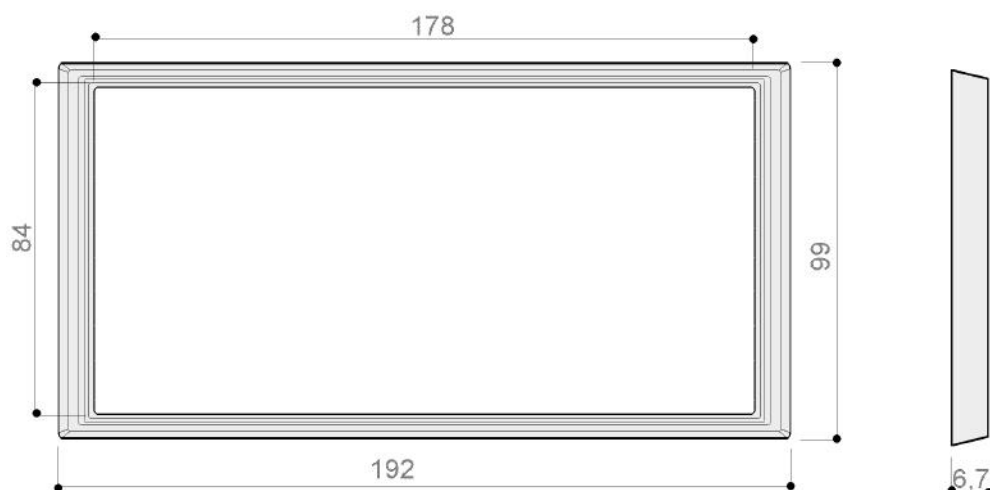

COR96192

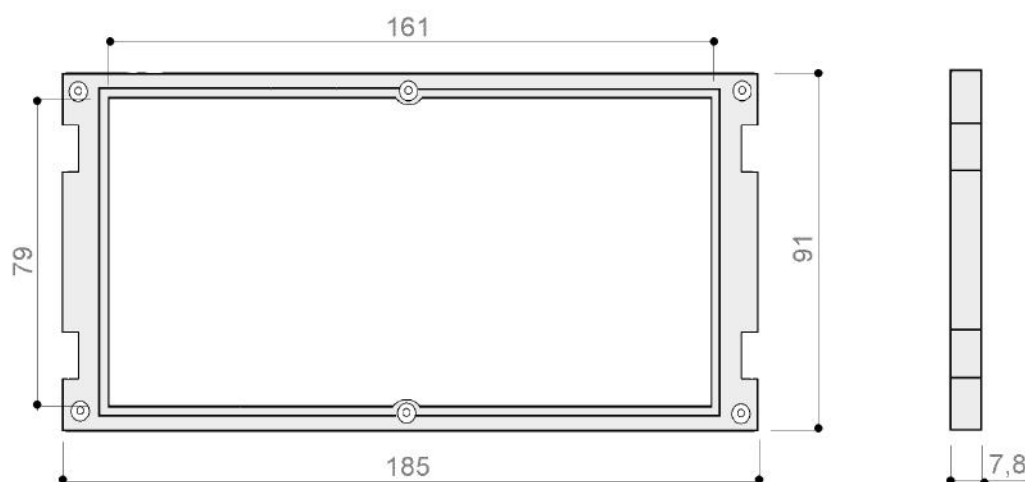

FD96192AP

SUPP96192: Cornice anteriore primo componente
COR96192: Cornice anteriore secondo componente

FD96192AP: Fondello posteriore aperto

Cataloghi Online: www.omar-alluminio.it
www.omar-alluminio.com

PROFILATI ALLUMINIO A DISEGNO / STANDARD / SPECIALI / E PER:
ELETTRONICA / LED / FOTOVOLTAICO / AUTOMAZIONE ROBOTICA / PNEUMATICA / AUTOMOTIVE

Via Newton, n.12
20016 Pero (Milano - Italy)
Tel. +39 02 3535955 r.a. Fax. +39 02 3539929
E-Mail: info@omar-alluminio.it

OMAR s.r.l.
PROFILATI ALLUMINIO
ALTA TECNOLOGIA

PANNELLI per contenitori porta schede elettroniche tipo DIN 43700

-DISEGNI PROFILI vedi pag. 1 -



Pannelli base completamente chiusi, con fori svasati per fissaggio al corpo contenitore, in alluminio 5005 ossidati naturale e protetti con pellicola PRONTI A MAGAZZINO per effettuare prototipi a cui faranno seguito:

- pannelli in alluminio a disegno del Cliente
- grezzi
- ossidati (neri, argento e colori a richieste del Cliente)
- serigrafia

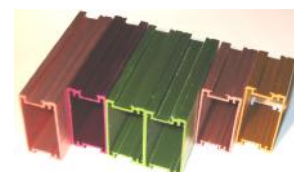

VTTS+2,9x10

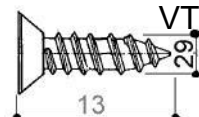
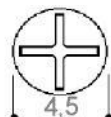
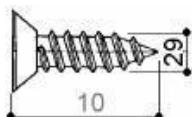

VTTS+2,9x13

Viti autofilettanti speciali con testa a diametro ridotto e taglio a croce. Adatte al fissaggio delle cornici e dei fondelli -

PANNELLI BASE IN ALLUMINIO OX.ARGENTO

DISEGNI A META DEL VERO (1:2) SPESSORE 15/10

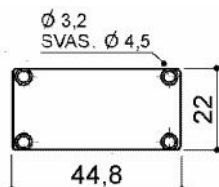

PB2448-A-207

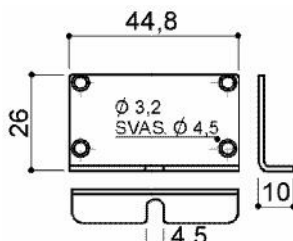

PBL2448-A-408

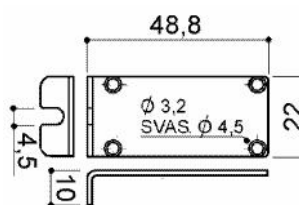

PBZ2448-A-608

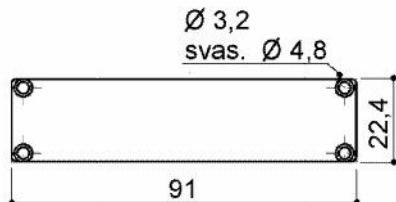

PB2496-A-204

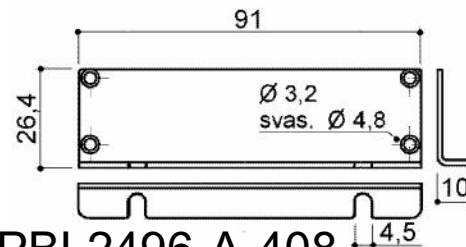

PBL2496-A-408

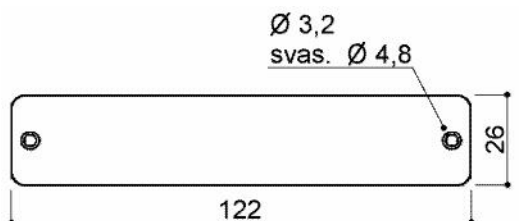

PB2207-A-1007

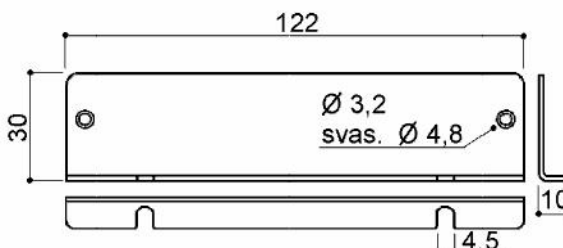

PBL2207-A-408

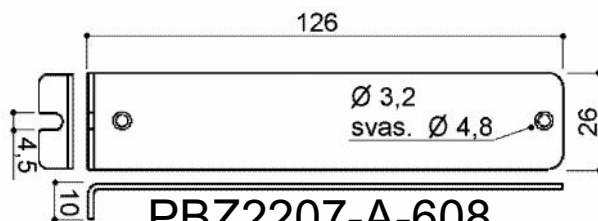

PBZ2207-A-608

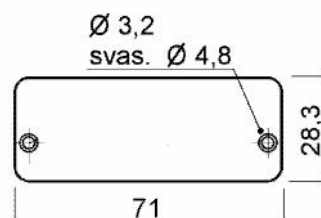

PB2126-A-1007

Si realizzano pannelli a disegno completi anche di serigrafie. Sul sito www.omar-alluminio.it sono disponibili i disegni in formato CAD per una semplice realizzazione dei Vs. pannelli 'custom'

PANNELLI per contenitori porta schede elettroniche tipo DIN 43700

-DISEGNI PROFILI vedi pag. 1 -



PANNELLI BASE IN ALLUMINIO OX.ARGENTO

DISEGNI A META DEL VERO (1:2) SPESSORE 15/10

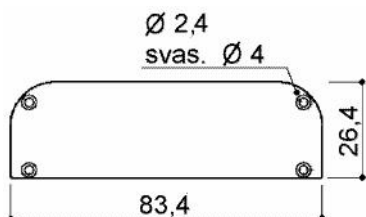

PB2091-A-208-R/F

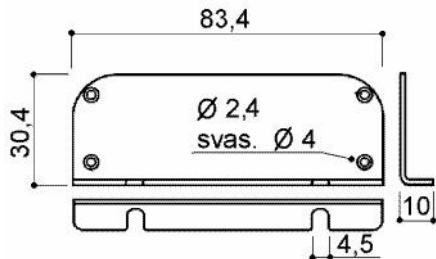

PBL2091-A-408-R/F

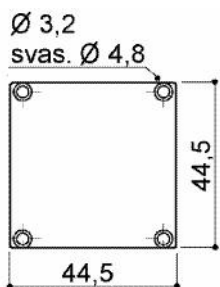

PB4848-A-199

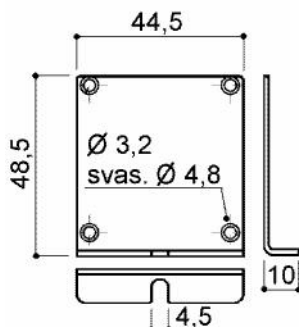

PBL4848-A-408

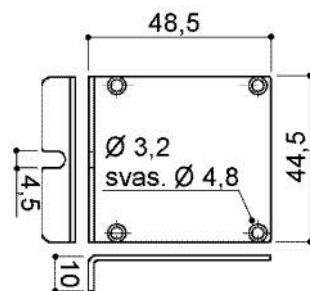

PBZ4848-A-608

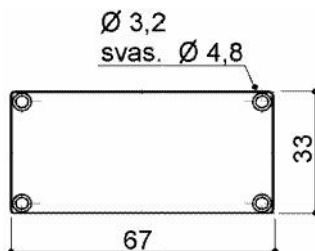

PB3672-A-102

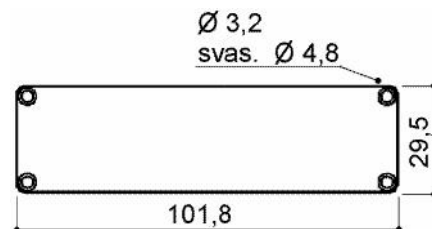
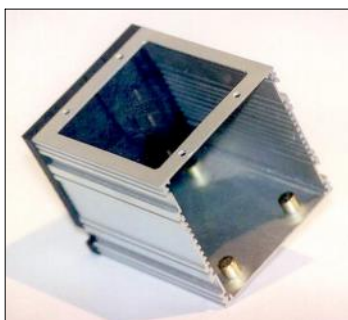

PB3696-A-1007

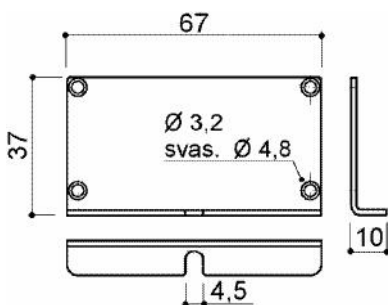

PBL3672-A-408

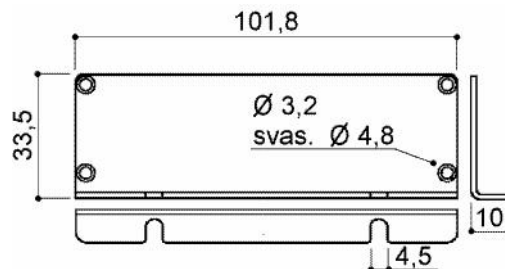

PBL3696-A-408

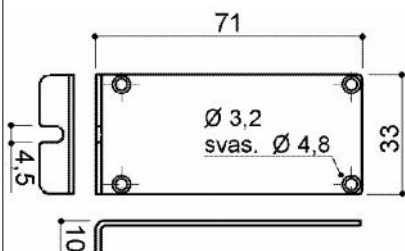

PBZ3672-A-608

Si realizzano pannelli a disegno completi anche di serigrafie. Sul sito www.omar-alluminio.it sono disponibili i disegni in formato CAD per una semplice realizzazione dei Vs. pannelli 'custom'

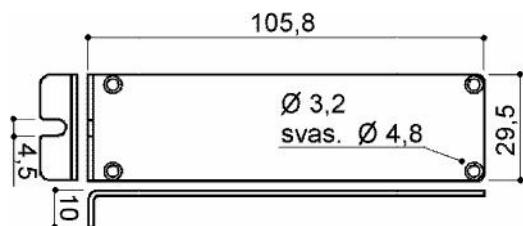

PBZ3696-A-608

Cataloghi Online: www.omar-alluminio.it
www.omar-alluminio.com

PROFILATI ALLUMINIO A DISEGNO / STANDARD / SPECIALI / E PER:
ELETTRONICA / LED / FOTOVOLTAICO / AUTOMAZIONE ROBOTICA / PNEUMATICA / AUTOMOTIVE

Via Newton, n.12
20016 Pero (Milano - Italy)
Tel. +39 02 3535955 r.a. Fax. +39 02 3539929
E-Mail: info@omar-alluminio.it

OMAR s.r.l.
PROFILATI ALLUMINIO
ALTA TECNOLOGIA

PANNELLI per contenitori porta schede elettroniche tipo DIN 43700

-DISEGNI PROFILI vedi pag. 1 -



PANNELLI BASE IN ALLUMINIO OX.ARGENTO

DISEGNI A META DEL VERO (1:2) SPESSORE 15/10

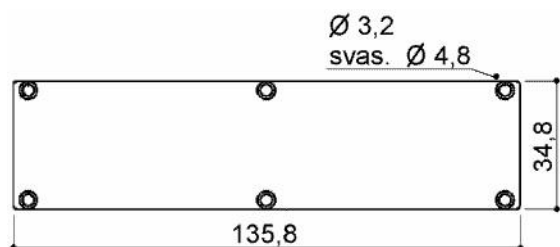

PB36144-A-1004

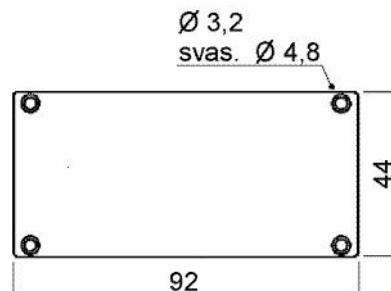

PB4896-A-199

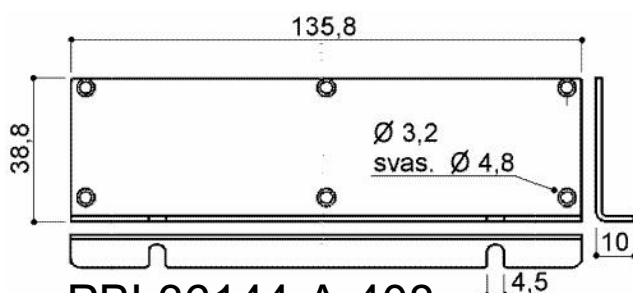

PBL36144-A-408

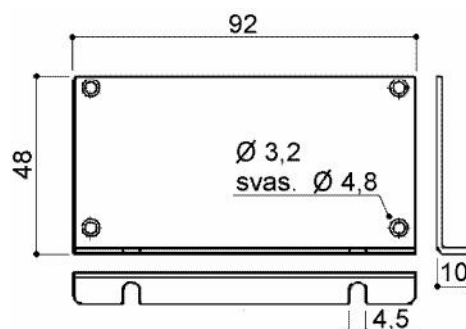

PBL4896-A-408

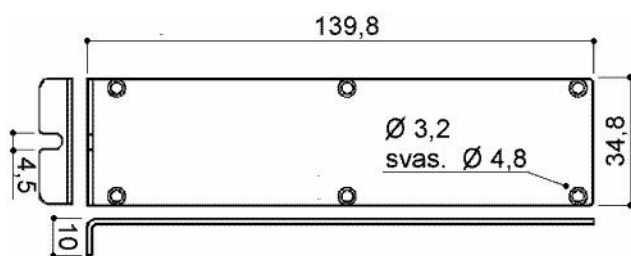

PBZ36144-A-608

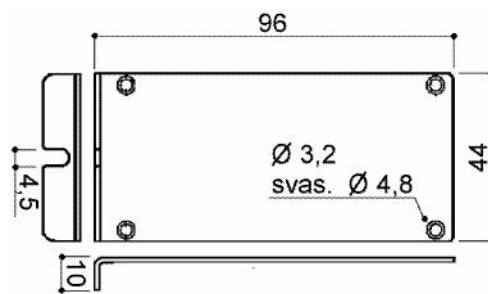

PBZ4896-A-608

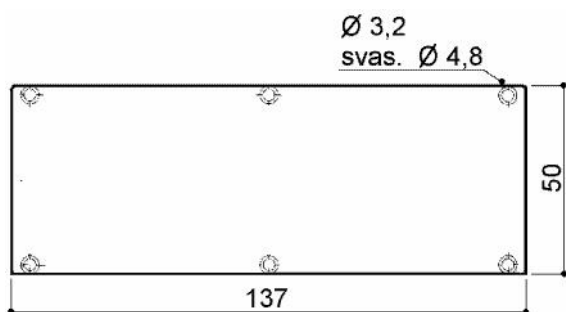

PB50144-A-1201

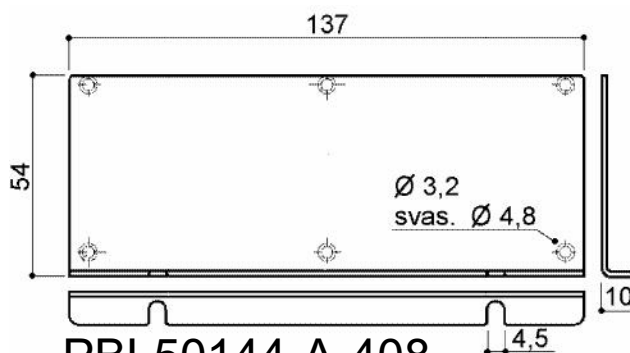

PBL50144-A-408

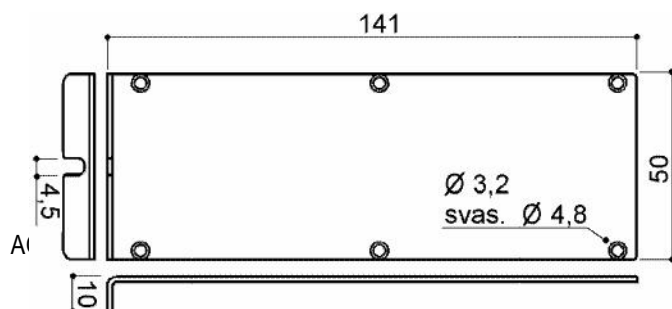

PBZ50144-A-608

Si realizzano pannelli a disegno completi anche di serigrafie. Sul sito www.omar-alluminio.it sono disponibili i disegni in formato CAD per una semplice realizzazione dei Vs. pannelli 'custom'

Via Newton, n.12

20016 Pero (Milano - Italy)

Tel. +39 02 3535955 r.a. Fax. +39 02 3539929

E-Mail: info@omar-alluminio.it

Cataloghi Online: www.omar-alluminio.it

www.omar-alluminio.com

PROFILATI ALLUMINIO A DISEGNO / STANDARD / SPECIALI / E PER:

ELETRONICA / LED / FOTOVOLTAICO / AUTOMAZIONE ROBOTICA / PNEUMATICA / AUTOMOTIVE



PANNELLI per contenitori porta schede elettroniche tipo DIN 43700

-DISEGNI PROFILI vedi pag. 1 -



PANNELLI BASE IN ALLUMINIO OX.ARGENTO

DISEGNI A META DEL VERO (1:2) SPESSORE 15/10

Cataloghi Online: www.omar-alluminio.it
www.omar-alluminio.com

PROFILATI ALLUMINIO A DISEGNO / STANDARD / SPECIALI / E PER:
 ELETTRONICA / LED / FOTOVOLTAICO / AUTOMAZIONE ROBOTICA / PNEUMATICA / AUTOMOTIVE

Via Newton, n.12
 20016 Pero (Milano - Italy)
 Tel. +39 02 3535955 r.a. Fax. +39 02 3539929
 E-Mail: info@omar-alluminio.it

PB48192-A-705

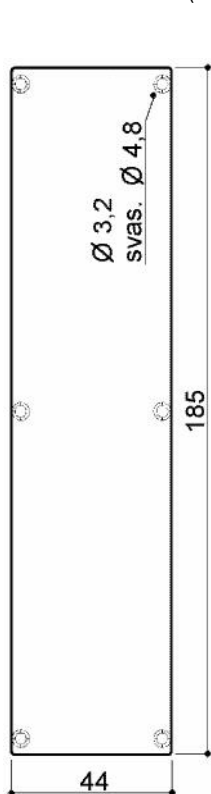

PBL48192-A-408

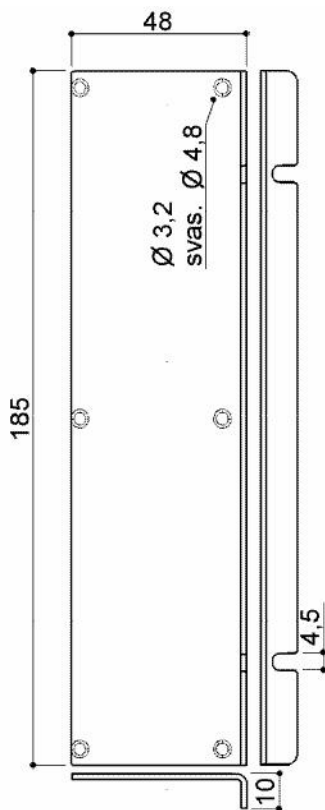

PBZ48192-A-608

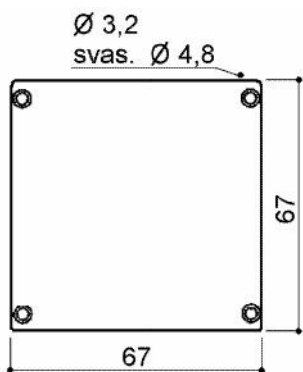
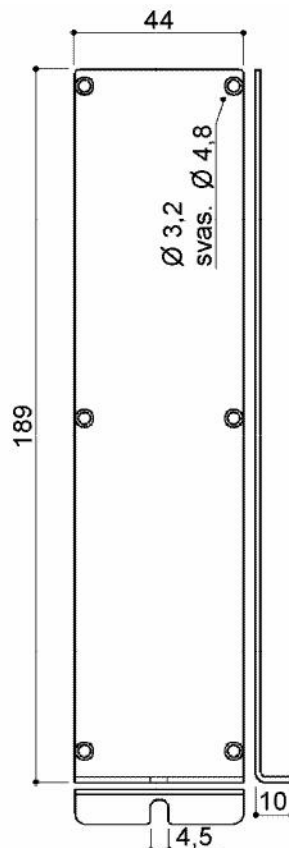

PB7272-A-199

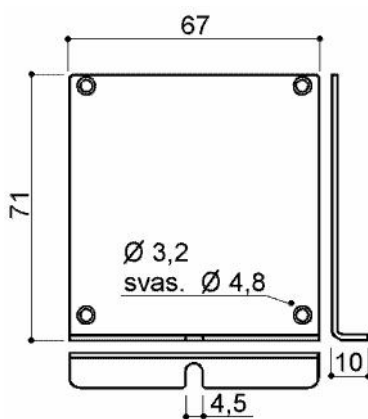

PBL7272-A-408

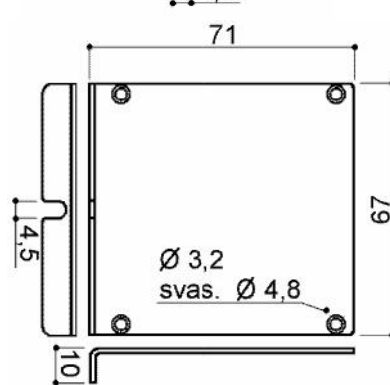

PBZ7272-A-608

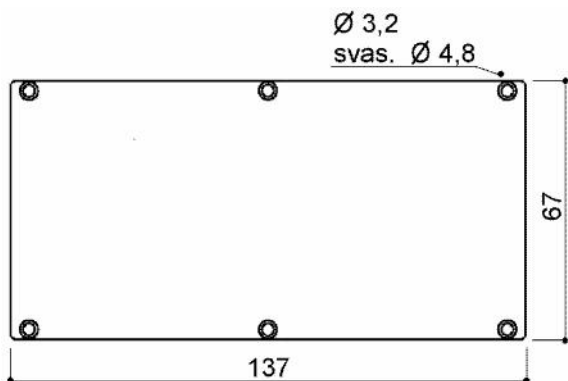

PB72144-A-199

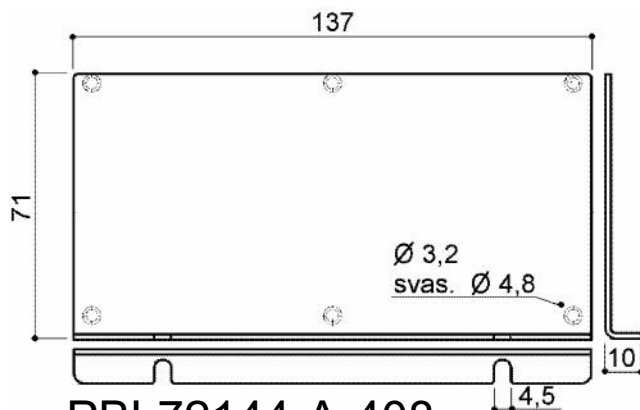

PBL72144-A-408

-RIPRODUZIONE VIETATA-

PANNELLI per contenitori porta schede elettroniche tipo DIN 43700

-DISEGNI PROFILI vedi pag. 1 -



PANNELLI BASE IN ALLUMINIO OX.ARGENTO

DISEGNI A META DEL VERO (1:2) SPESSORE 15/10

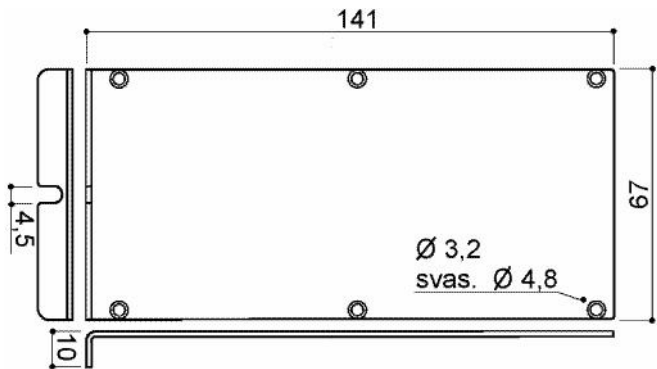

PBZ72144-A-608

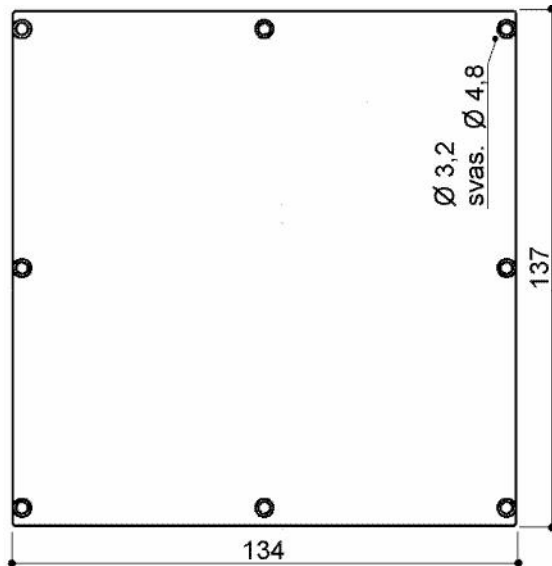

PB144144-A-605

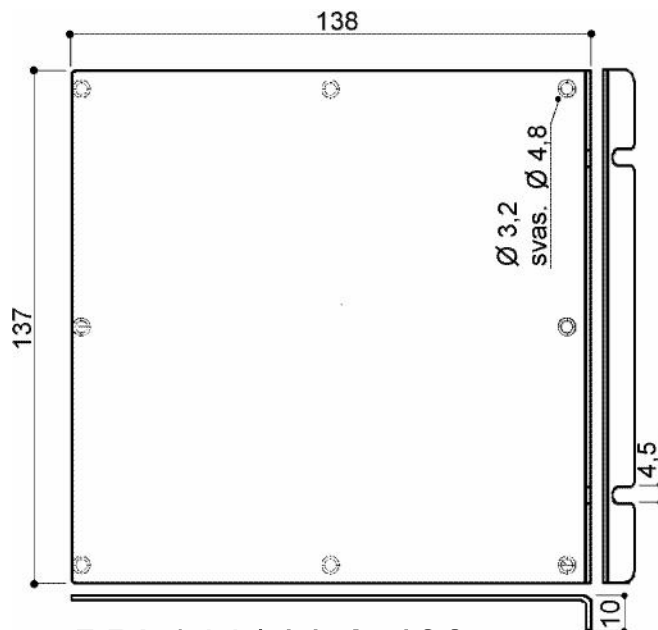

PBL144144-A-408

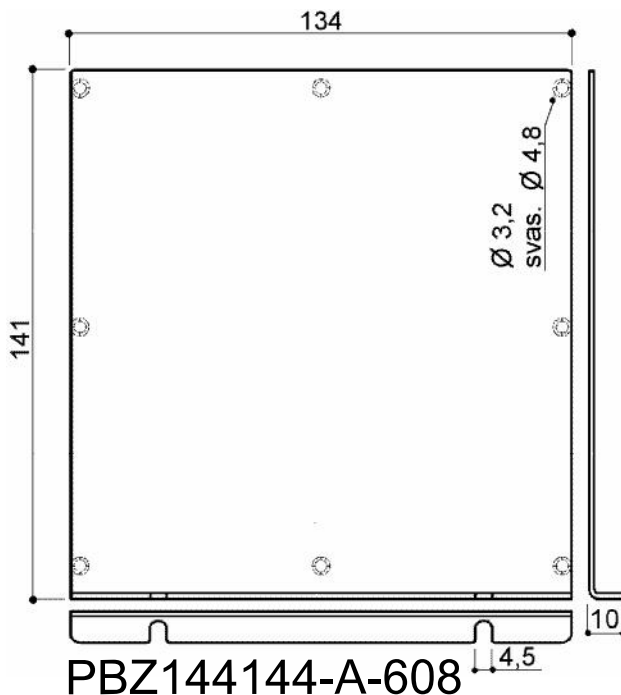

PBZ144144-A-608

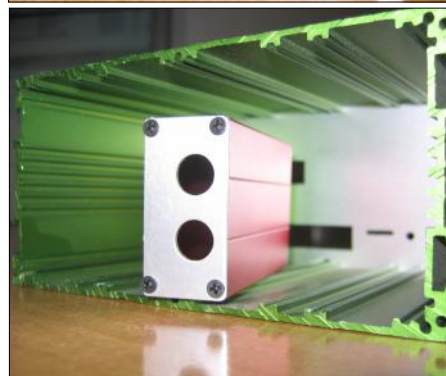

Si realizzano pannelli a disegno completi anche di serigrafie. Sul sito www.omar-alluminio.it sono disponibili i disegni in formato CAD per una semplice realizzazione dei Vs. pannelli 'custom'

Cataloghi Online: www.omar-alluminio.it
www.omar-alluminio.com

PROFILATI ALLUMINIO A DISEGNO / STANDARD / SPECIALI / E PER:
ELETTRONICA / LED / FOTOVOLTAICO / AUTOMAZIONE ROBOTICA / PNEUMATICA / AUTOMOTIVE

Via Newton, n.12
20016 Pero (Milano - Italy)
Tel. +39 02 3535955 r.a. Fax. +39 02 3539929
E-Mail: info@omar-alluminio.it



PANNELLI per contenitori porta schede elettroniche tipo DIN 43700

-DISEGNI PROFILI vedi pag. 1 -



PANNELLI BASE IN ALLUMINIO OX.ARGENTO

DISEGNI A META DEL VERO (1:2) SPESSORE 15/10

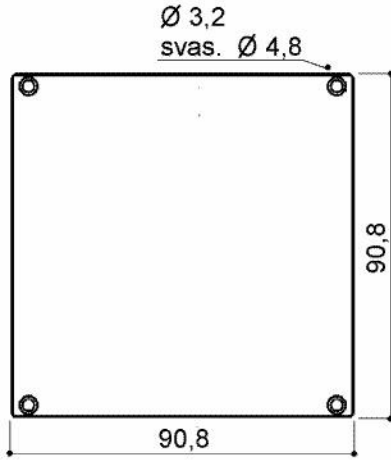

PB9696-A-499

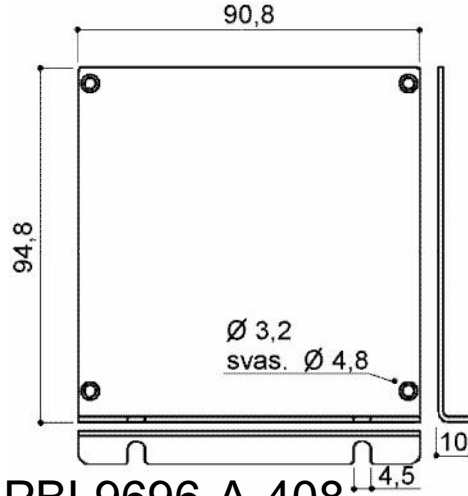

PBL9696-A-408

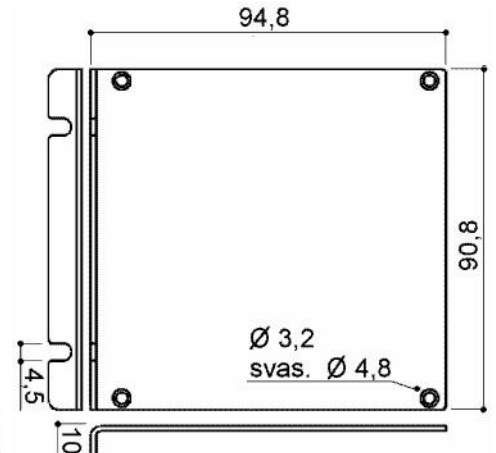

PBZ9696-A-608

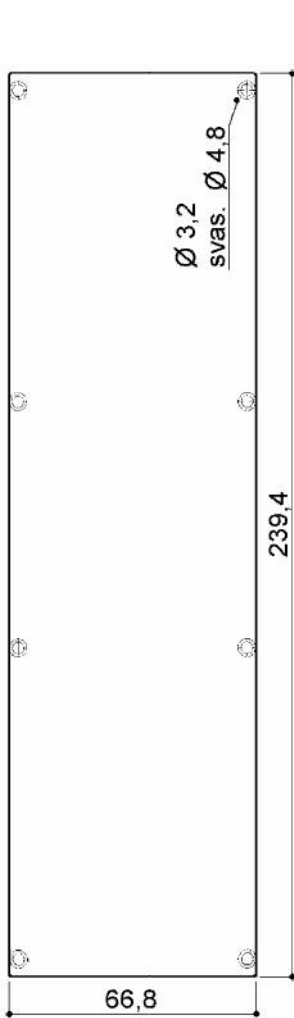

PB72216-A-108

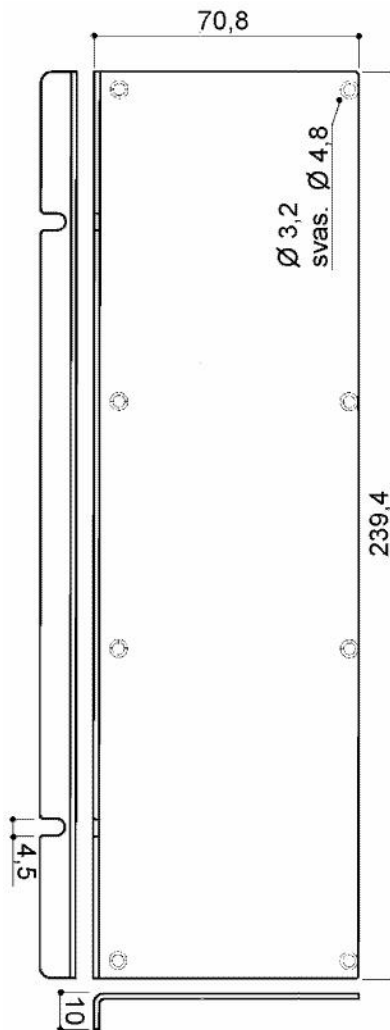

PBL72216-A-408

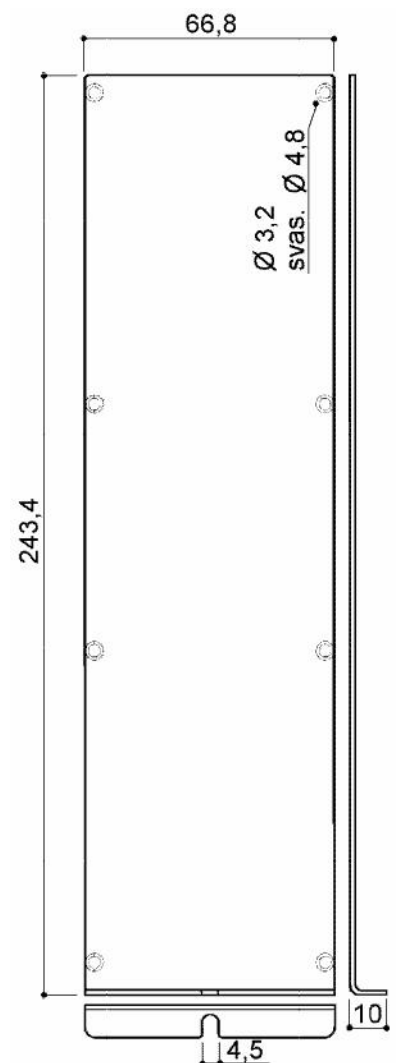

PBZ72216-A-608

Cataloghi Online: www.omar-alluminio.it

www.omar-alluminio.com

PROFILATI ALLUMINIO A DISEGNO / STANDARD / SPECIALI / E PER:

ELETTRONICA / LED / FOTOVOLTAICO / AUTOMAZIONE ROBOTICA / PNEUMATICA / AUTOMOTIVE

Via Newton, n.12

20016 Pero (Milano - Italy)

Tel. +39 02 3535955 r.a. Fax. +39 02 3539929

E-Mail: info@omar-alluminio.it

OMAR s.r.l.
PROFILATI ALLUMINIO
ALTA TECNOLOGIA

PANNELLI per contenitori porta schede elettroniche tipo DIN 43700

-DISEGNI PROFILI vedi pag. 1-



PANNELLI BASE IN ALLUMINIO OX.ARGENTO

DISEGNI A META DEL VERO (1:2) SPESSORE 15/10

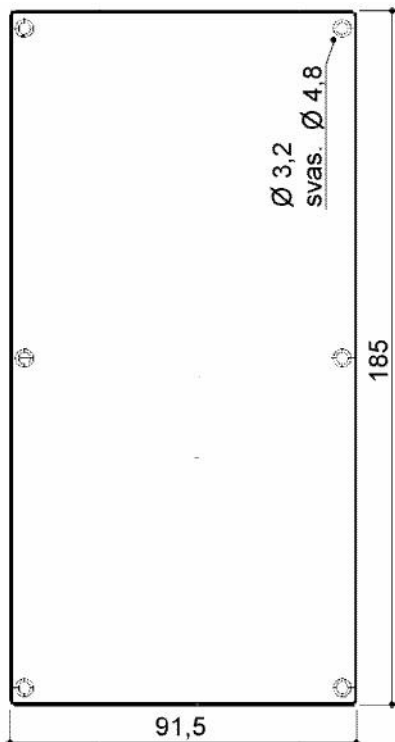

PB96192-A-705

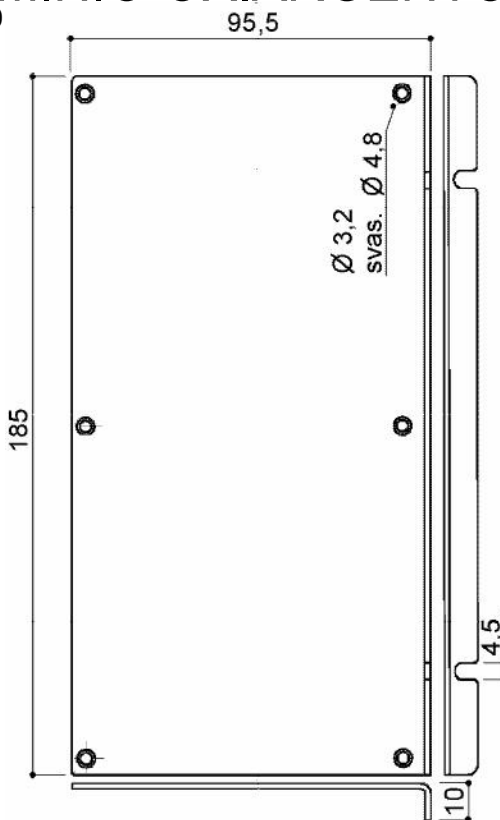

PBL96192-A-408

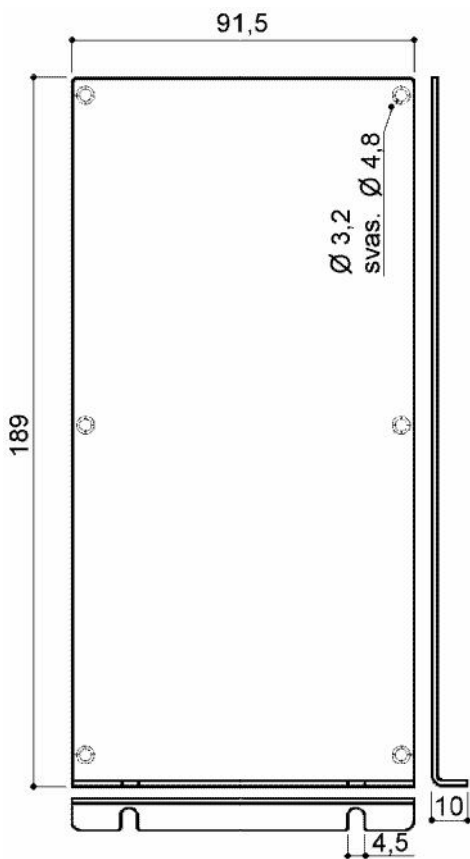

PBZ96192-A-608

Si realizzano pannelli a disegno completi anche di serigrafie. Sul sito www.omar-alluminio.it sono disponibili i disegni in formato CAD per una semplice realizzazione dei pannelli 'custom'.

Cataloghi Online: www.omar-alluminio.it
www.omar-alluminio.com

PROFILATI ALLUMINIO A DISEGNO / STANDARD / SPECIALI / E PER:

ELETTRONICA / LED / FOTOVOLTAICO / AUTOMAZIONE ROBOTICA / PNEUMATICA / AUTOMOTIVE

Via Newton, n.12

20016 Pero (Milano - Italy)

Tel. +39 02 3535955 r.a. Fax. +39 02 3539929

E-Mail: info@omar-alluminio.it



PANNELLI per contenitori porta schede elettroniche tipo DIN 43700

-DISEGNI PROFILI vedi pag. 1 -

DISEGNI A META DEL VERO (1:2)- SCALE 1:2



Cataloghi Online: www.omar-alluminio.it

www.omar-alluminio.com

PROFILATI ALLUMINIO A DISEGNO / STANDARD / SPECIALI / E PER:

ELETTRONICA / LED / FOTOVOLTAICO / AUTOMAZIONE ROBOTICA / PNEUMATICA / AUTOMOTIVE

Via Newton, n.12

20016 Pero (Milano - Italy)

Tel. +39 02 3535955 r.a. Fax. +39 02 3539929

E-Mail: info@omar-alluminio.it

OMAR s.r.l.
PROFILATI ALLUMINIO
ALTA TECNOLOGIA

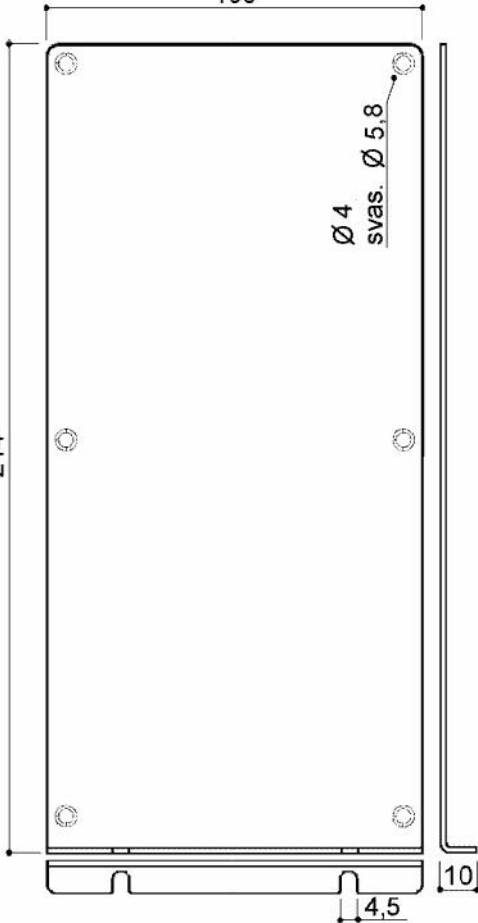

PBZ2154-A-608

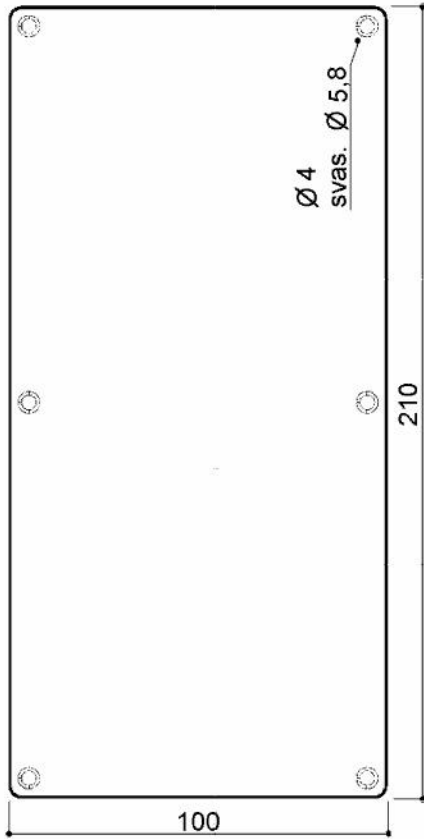

PB2154-A-1007

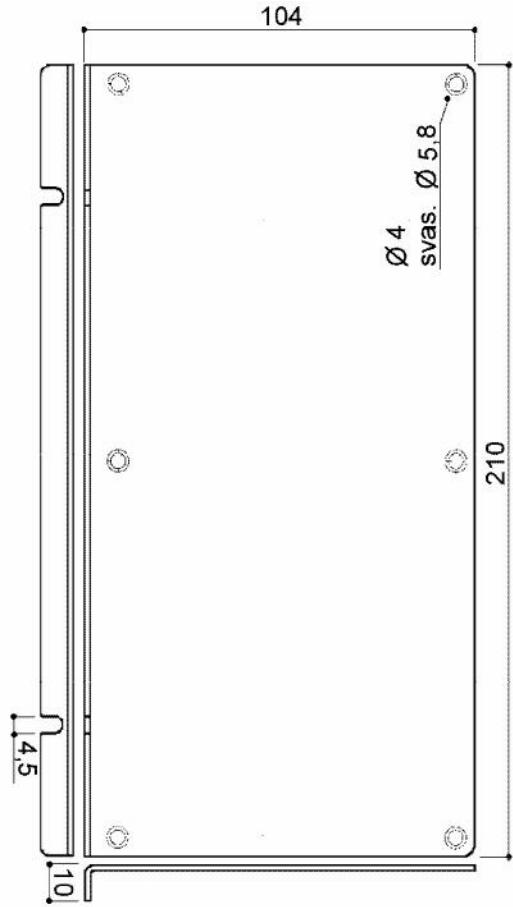

PBL2154-A-408

SPESSORE 15/10

PANNELLI BASE IN ALLUMINIO OX.ARG.



Si realizzano pannelli a disegno completi anche di serigrafie. Sul sito www.omar-alluminio.it sono disponibili I disegni in formato CAD per una semplice realizzazione dei Vs. pannelli 'custom'

ACCESSORI per profili componibili, banchi e linee modulari - Profili strutturali -



Gamma completa per:

-Profili in alluminio con ossidazione naturale in barre o tagliati a misura

-Accessori adatti alla realizzazione di strutture modulari (passare a pag.71 per i disegni dei profili)

Serie 40

Squadrette 90°



Squadretta in alluminio 40x40x40 anodizzato argento
Utilizzabile con art.726 727 728 729 730 731 732 733 734 740
741 742 743 744 747
Codice Art.: 3-5431/A



Squadretta in alluminio 40x40x80.
Utilizzabile con art.726 727 728 729 730 731 732 733 734 740
741 742 743 744 747
Codice Art.: F-0074



Squadretta in alluminio 60x60x40.
Utilizzabile con art.726 727 728 729 730 731 732 733 734 740
741 742 743 744 747
Codice Art.: 3-6431

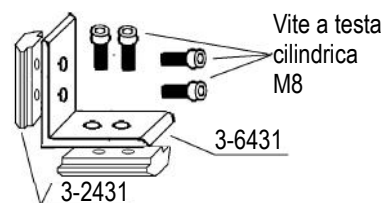
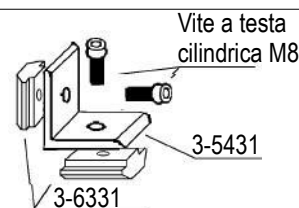

Squadretta in alluminio 40x40x20.
Utilizzabile con art.726 727 728 729 730 731 732 733 734 740
741 742 743 744 747
Codice Art.: 3-7431



Squadretta in alluminio 40x40x40.
Utilizzabile con art.726 727 728 729 730 731 732 733 734 740
741 742 743 744 747
Codice Art.: 3-8431



Squadretta in alluminio 40x40x80.
Utilizzabile con art.726 727 728 729 730 731 732 733 734 740
741 742 743 744 747
Codice Art.: 3-9431

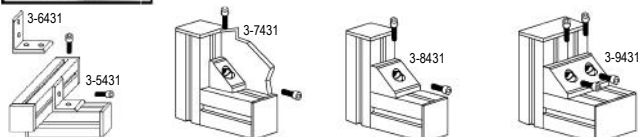

Esempio di utilizzo degli articoli sopra riportati

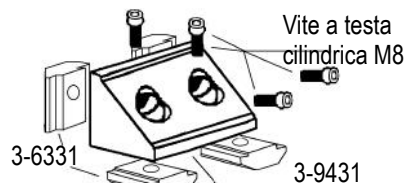
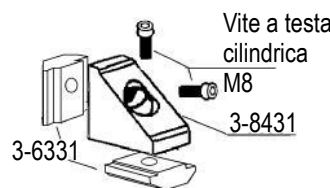
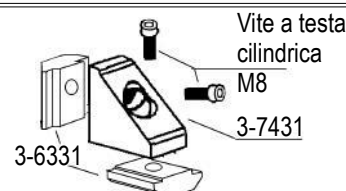

Squadretta in alluminio 80x80x40.
Utilizzabile con art.726 727 728 729 730 731 732 733 734 740
741 742 743 744 747
Codice Art.: 3-0531



Squadretta in alluminio 80x80x80.
Utilizzabile con art.728 729 732 733 734 740
741 742 743 744 747
Codice Art.: 3-1531



Squadretta in alluminio 80x80x120.
Utilizzabile con art.734 747 749 741 743 742
Codice Art.: 3-2241

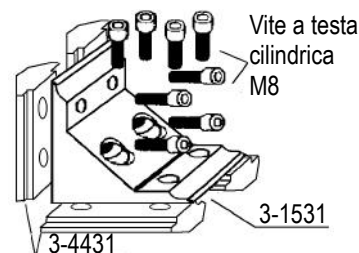
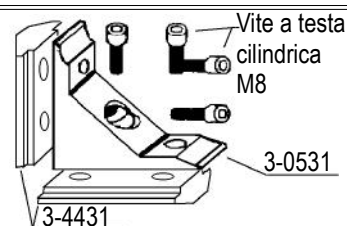

Esempio di utilizzo degli articoli sopra riportati

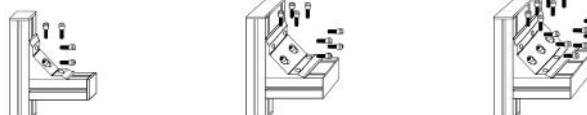

Via Newton, n.12
20016 Pero (Milano - Italy)
Tel. +39 02 3535955 r.a. Fax. +39 02 3539929
E-Mail: info@omar-alluminio.it

Cataloghi Online: www.omar-alluminio.it
www.omar-alluminio.com

PROFILATI ALLUMINIO A DISEGNO / STANDARD / SPECIALI / E PER:
ELETTRONICA / LED / FOTOVOLTAICO / AUTOMAZIONE ROBOTICA / PNEUMATICA / AUTOMOTIVE



ACCESSORI per profili componibili, banchi e linee modulari - Profili strutturali



Gamma completa per:

-Profili in alluminio con ossidazione naturale in barre o tagliati a misura

-Accessori adatti alla realizzazione di strutture modulari (passare a pag.71 per i disegni dei profili)

Serie 40

Via Newton, n.12
20016 Pero (Milano - Italy)
Tel.+39 02 3535955 r.a. Fax.+39 02 3539929
E.Mail: info@omar-alluminio.it

Cataloghi Online: www.omar-alluminio.it
www.omar-alluminio.com

PROFILATI ALLUMINIO A DISEGNO / STANDARD / SPECIALI / E PER:
ELETTRONICA / LED / FOTOVOLTAICO / AUTOMAZIONE ROBOTICA / PNEUMATICA / AUTOMOTIVE

Piastra in alluminio
Codice Art. F-0078 40x80 per giunzione a 90°
Codice Art. F-0082 80x80 per collegamento



Esempio utilizzo F-0082

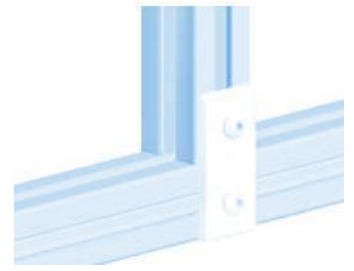

Esempio utilizzo F-0078



Piastrina in alluminio anti-rotazione per collegamenti 90

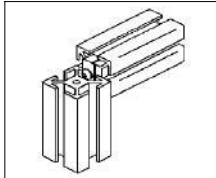

Codice Art.: 3-3241

Foro passante
diametro 7
per chiave
esagonare

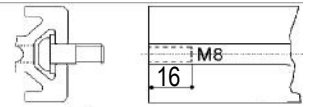

3-3241
Vite testa
cilindrica
M8

22,5



Cursore alluminio lunghezza 18mm
con 1 foro M6 Codice Art.3-5331
con 1 foro M8 Codice Art 3-6331
con 1 foro M4 Codice Art 3-0341



Cursore alluminio lunghezza 40mm con
2 fori M6 interasse 20 mm - Codice Art.3-9331
Cursore alluminio lunghezza 40mm con
2 fori M8 interasse 25 mm Codice Art.3-2431



Cursore alluminio lunghezza 50mm con
2 fori M6 interasse 30 mm Codice Art.3-0431
Cursore alluminio lunghezza 50mm con
2 fori M8 interasse 30 mm Codice Art.3-3431



Cursore alluminio lunghezza 60mm con
2 fori M6 interasse 40 mm Codice Art.3-1431
Cursore alluminio lunghezza 60mm con
2 fori M8 interasse 40 mm Codice Art.3-4431



Cursore in acciaio zincato a 'culla' per
montaggio frontale da 22 mm con sferetta
Codice Art.3-1731 M8
Codice Art.3-0731 M6

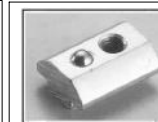

Cursore in acciaio zincato da 22 mm con sferetta
Codice Art.3-2731 M6
Cursore in acciaio zincato da 22 mm con sferetta
Codice Art.3-3731 M8



Piastra romboidale filettata m8
in acciaio zincato misure 23x15x6
Codice Art.F-0029

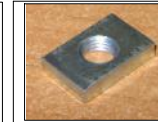

Piastrina in acciaio zincato 20x13
spessore 5 mm
M8 Cod Art.F-0030
M6 Cod Art.F-0044



Cursore a martello M8x25 in acciaio
zincato per montaggio frontale.
Codice Art.3-9341

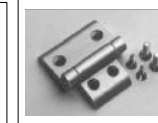

Cerniera alluminio con perno diametro
7 mm.
Codice Art.3-1141



Prolunga profilo completa di grani
M8 a punta
Cod. Art.3-5341 versione in acciaio zincato
Cod. Art.4-0019 versione in alluminio Lega 6082



Ruota per porte scorrevoli
Cod. Art.F-0061



Collegamento 90° a scomparsa
in acciaio zincato per serie 40
Codice Art.F-0067



ACCESSORI per profili componibili, banchi e linee



modulari - Profili strutturali

Gamma completa per:

-Profili in alluminio con ossidazione naturale in barre o tagliati a misura

-Accessori adatti alla realizzazione di strutture modulari (passare a pag.71 per i disegni dei profili)

Serie 40

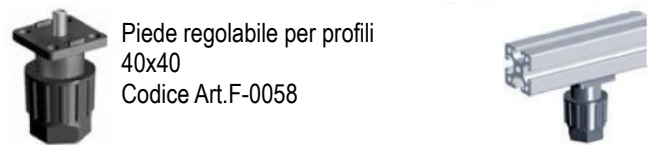

Piede regolabile per profili 40x40
Codice Art.F-0058

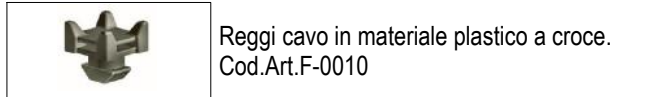

Reggi cavo in materiale plastico a croce.
Cod.Art.F-0010



Reggi cavo in materiale plastico.
Cod.Art.F-0009

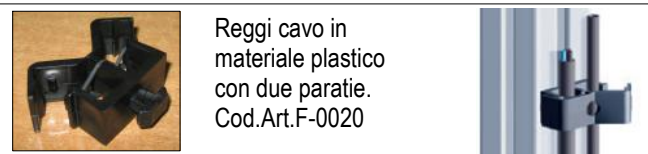

Reggi cavo in materiale plastico con due paratie.
Cod.Art.F-0020



Reggi cavo in materiale plastico doppio
Cod.Art.F-0024

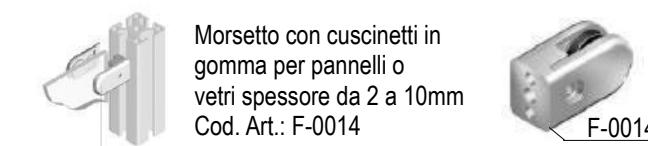

Morsetto con cuscinetti in gomma per pannelli o vetri spessore da 2 a 10mm
Cod. Art.: F-0014



Giunzione 90° per porta pannello F-0014
Cod. Art.: F-0015

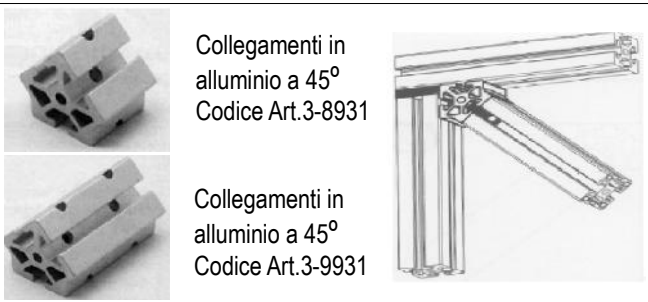
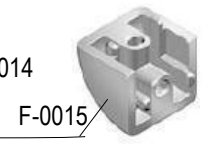

Collegamenti in alluminio a 45°
Codice Art.3-8931

Collegamenti in alluminio a 45°
Codice Art.3-9931



Giunto in metallo 40x40 con snodo e brugola di bloccaggio.
Codice Art.: 3-7341

Giunto 90°

Giunto in alluminio per collegamenti a 90° singolo (40x40) e doppio (40x80). Utilizzabile con Art.: 726 727 728 729 730 731 732 733 734 739 740 741 742 743 747

Codice Art. 3-5241 (80x80)
Codice Art. 3-7131 (40x40)
Codice Art. 3-8041 (40x40) con scasso x tamponamento
Codice Art. 3-6241 (40x80)
Codice Art. 3-8131 (40x80)
Codice Art. 3-6441 (60X60)

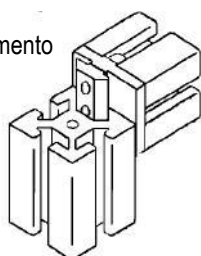

3-7131 (40x40)

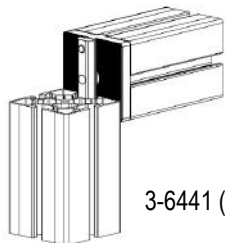

3-6441 (60X60)



3-5241 (80x80)



3-7131 (40x40)



3-8041 (40X40)



3-6441 (60X60)



3-6241 (40x80)



3-8131 (40x80)

ISTRUZIONI PER L'UTILIZZO

FASE A) Montare la vite M8x16 e le viti M6x22 sul giunto

FASE B) Avvitare la vite M8x16 sul profilo

FASE C) Collegare il secondo profilo al giunto

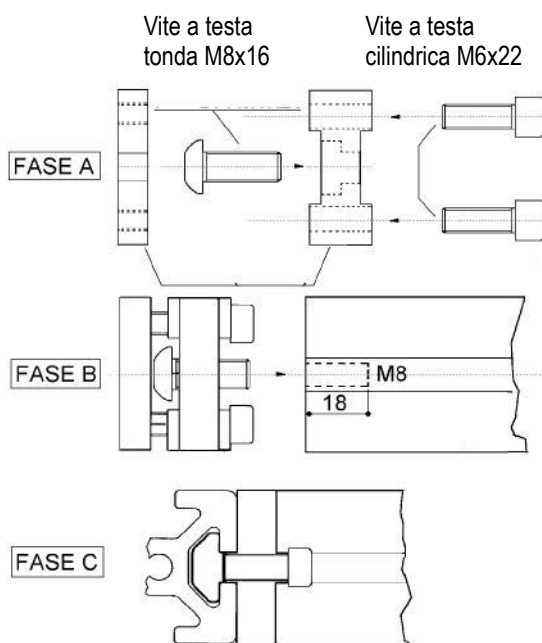

Via Newton, n.12
20016 Pero (Milano - Italy)
Tel.+39 02 3535955 r.a. Fax.+39 02 3539929
E-Mail: info@omar-alluminio.it

Cataloghi Online: www.omar-alluminio.it
www.omar-alluminio.com

PROFILATI ALLUMINIO A DISEGNO / STANDARD / SPECIALI / E PER:
ELETTRONICA / LED / FOTOVOLTAICO / AUTOMAZIONE ROBOTICA / PNEUMATICA / AUTOMOTIVE



ACCESSORI per profili componibili, banchi e linee

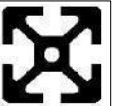

modulari - Profili strutturali

Gamma completa per:

-Profili in alluminio con ossidazione naturale in barre o tagliati a misura

-Accessori adatti alla realizzazione di strutture modulari (passare a pag.71 per i disegni dei profili)

Serie 40

Giunto 90°

Giunto in alluminio per collegamenti a 90°.
Utilizzabile con Art.: 726 727 728 729 730 731
732 733 734 739 740 741 742 743 747
Codice Art.3-9131

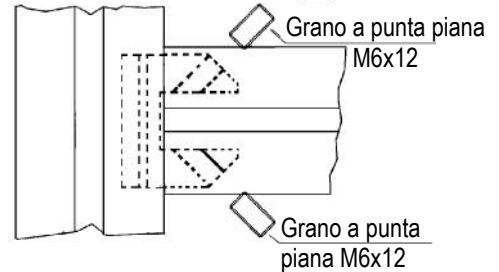
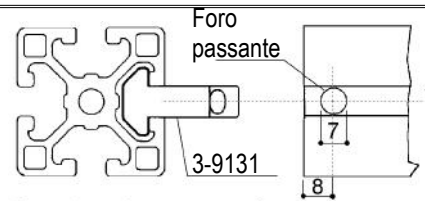

3-9131

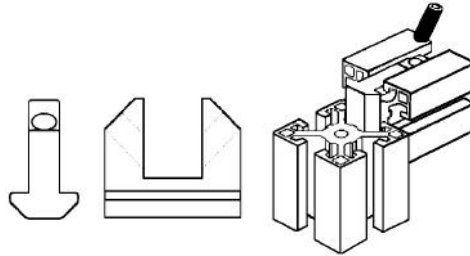

3-5441

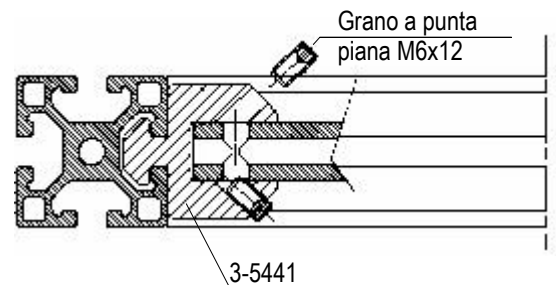
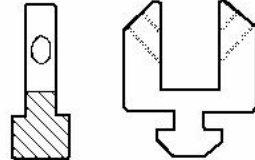

Via Newton, n.12
20016 Pero (Milano - Italy)
Tel.+39 02 3535955 r.a. Fax.+39 02 3539929
E.Mail: info@omar-alluminio.it

Cataloghi Online: www.omar-alluminio.it
www.omar-alluminio.com
PROFILATI ALLUMINIO A DISEGNO / STANDARD / SPECIALI / E PER:
ELETTRONICA / LED / FOTOVOLTAICO / AUTOMAZIONE ROBOTICA / PNEUMATICA / AUTOMOTIVE



Maniglia in
materiale plastico interasse 122mm.
Cod. Art.3-1131



Maniglia in materiale plastico
antifortunistica.
Cod. Art.3-4021



Blocchetto nero di fissaggio
in plastica.
Codice Art.3-8831



Distanziale in plastica.
Cod. Art.3-9831 distanziale per pannello da 6mm
Cod. Art.3-0931 distanziale per pannello da 5mm
Cod. Art.3-1931 distanziale per pannello da 3mm

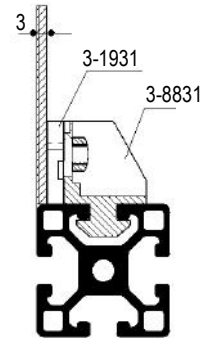
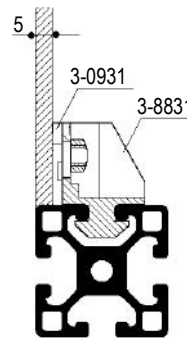
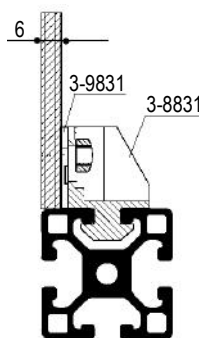
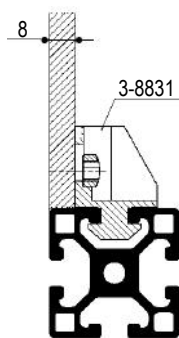

Giunto 90° a 3 vie



Giunto in alluminio per collegamenti a 90°
3 vie. Utilizzabile con Art.: 750 740
Codice Art.3-3341

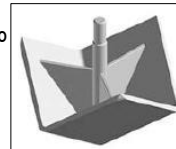

Tappo in nylon nero
quadrato Utilizzabile
con Art.: 740 3-3341
Codice Art.F-0012

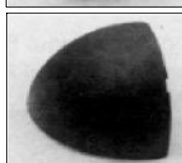

Tappo in nylon nero
Utilizzabile con Art.: 750 3-3341
Cod. Art.3-4341

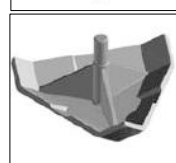

Tappo in nylon nero
trapezoidale Utilizzabile
con Art.: 740 3-3341
Codice Art.F-0013



3-3341 (giunto)
3-4341 (tappo)
F-0012 (tappo)
F-0013 (tappo)



ACCESSORI per profili componibili, banchi e linee



modulari - Profili strutturali

Gamma completa per:

-Profili in alluminio con ossidazione naturale in barre o tagliati a misura

-Accessori adatti alla realizzazione di strutture modulari (passare a pag.71 per i disegni dei profili)

Serie 40

Giunto 90°

3-2231 (3VIE)

Giunto in alluminio per collegamenti a 90° a 2 o 3 vie. Utilizzabile con Art.: 726 727 728 729 730 731 732 733 734 739 740 741 742 743 747

Codice Art.3-1231 giunto 2 vie

Codice Art.3-2231 giunto 3 vie

Codice Art.3-9041 giunto 2 vie con scasso per tamponamento

Codice Art.3-0141 giunto 3 vie con scasso per tamponamento

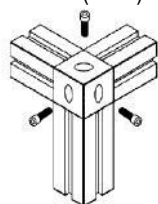

3-9041



3-1231



3-0141



3-2231

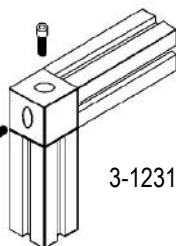

3-1231 (2VIE)

3-1231 (2VIE)

3-2231 (3VIE)

Vite a testa cil. M8

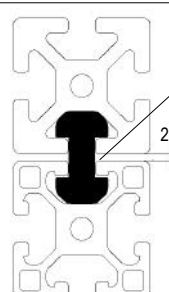
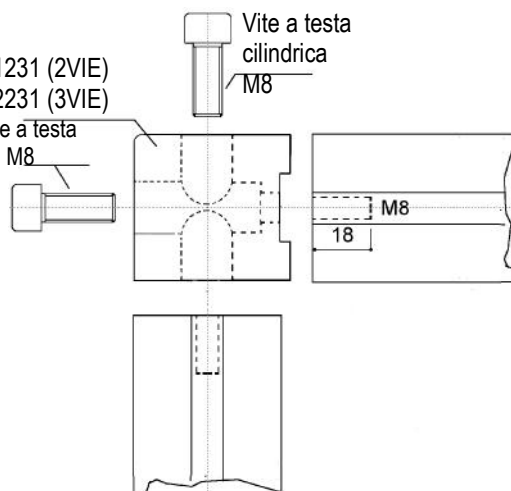

3-8241

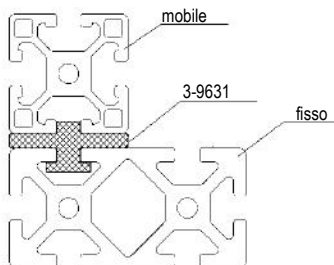

3-9631

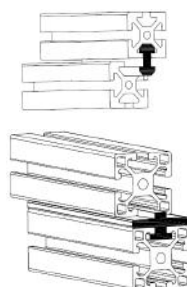

Guide di scorrimento

Guide di scorrimento in materiale plastico.

Lunghezza barre 3mt.

Cod. Art.3-8241

Cod. Art.3-9631

Accessori per l'ancoraggio a terra

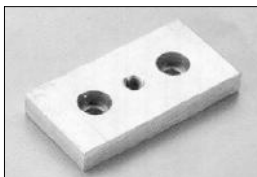

Piastra in alluminio 40x80 adatta a piedi snodati

Utilizzabile con art.726 732

Cod. Art.3-3531 Con foro centrale filettato M8

Cod. Art.3-4531 Con foro centrale filettato M10

Cod. Art.3-5531 Con foro centrale filettato M12



Piastra in alluminio 80x80 adatta a piedi snodati

Utilizzabile con art.729 733

Cod. Art.3-6531 con foro centrale M12

Cod. Art.3-7531 con foro centrale M16



Piastra in alluminio adatta al fissaggio di ruote

Utilizzabile con art.729 733 3-4231 3-5231 3-6231

Cod. Art.3-8531



Ruota girevole in acciaio-gomma

Cod. Art.3-4231 diametro 50mm

Cod. Art.3-5231 diametro 100mm

Cod. Art.3-6231 diametro 100mm con freno



Base diametro 40 in poliammide Utilizzabile con art. 3-4831

3-5831 3-6831 3-7531

Cod. Art.3-8731



Base diametro 60 in poliammide Utilizzabile con art. 3-4831

3-5831 3-6831 3-7531

Cod. Art.3-0831

Via Newton, n.12
20016 Pero (Milano - Italy)
Tel.+39 02 3535955 r.a. Fax.+39 02 3539929
E-Mail: info@omar-alluminio.it

Cataloghi Online: www.omar-alluminio.it
www.omar-alluminio.com
PROFILATI ALLUMINIO A DISEGNO / STANDARD / SPECIALI / E PER:
ELETTRONICA / LED / FOTOVOLTAICO / AUTOMAZIONE ROBOTICA / PNEUMATICA / AUTOMOTIVE

AGGIORNAMENTO CONTINUO - ED. DEL 03-2023-RIPRODUZIONE VIETATA-



ACCESSORI per profili componibili, banchi e linee modulari - Profili strutturali



Gamma completa per:

- Profili in alluminio con ossidazione naturale in barre o tagliati a misura
- Accessori adatti alla realizzazione di strutture modulari (passare a pag.71 per i disegni dei profili)

Serie 40

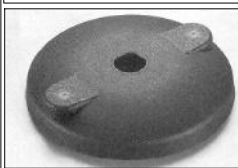

Base diametro 80 in poliammide
Utilizzabile con art. 3-4831 3-5831 3-6831 3-7531
Cod. Art.3-2831



Perno con sfera in acciaio zincato
Cod. Art.3-4831 M8x80
Cod. Art.3-5831 M10x90
Cod. Art.3-6831 M12x100
Cod. Art.3-7831 M16x100



Staffa in acciaio zincato per il fissaggio a terra della struttura
Cod. Art.3-2531 Item no.: 3-2531



Sfera in acciaio zincato
Cod. Art.F-0071 M6
Cod. Art.F-0072 M8

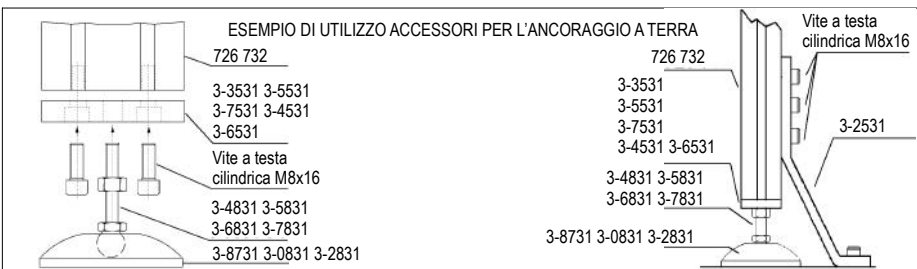

Squadretta di collegamento in alluminio pressofuso per angolazioni da 0° a 180°.
Cod. Art.F-0031



Squadretta di collegamento per angolazioni da 0° a 180°.
Cod. Art.F-0032



Squadretta di collegamento in acciaio zincato per angolazioni da 0° a 180°.
Cod. Art.F-0033

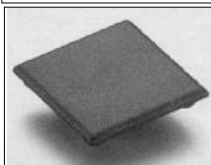

Tappo in nylon nero 40x40
Utilizzabile con art.727 730 731 739
Cod. Art.3-3631

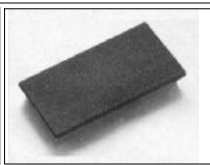

Tappo in nylon nero 40x80
Utilizzabile con art.726 732
Cod. Art.3-5631

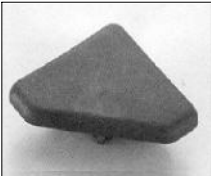

Tappo in nylon nero
Utilizzabile con art.728 740
Cod. Art.3-4631

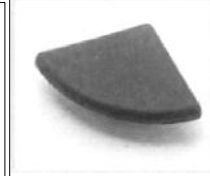

Tappo in nylon nero
Utilizzabile con art.750
Cod. Art.3-6341

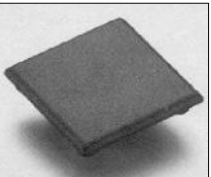

Tappo in nylon nero 80x80
Utilizzabile con art.729 733
Cod. Art.3-6631

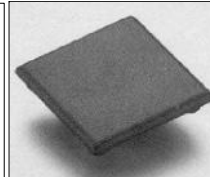

Tappo in nylon nero 60x60
Utilizzabile con art.757
Cod. Art.3-7141



Tappo in nylon nero 30x70
Utilizzabile con art.760
Cod. Art.3-3141

ACCESSORI per profili componibili, banchi e linee

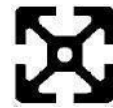

modulari - Profili strutturali

Gamma completa per:

- Profili in alluminio con ossidazione naturale in barre o tagliati a misura
- Accessori adatti alla realizzazione di strutture modulari (passare a pag.71 per i disegni dei profili)

Serie 45



Squadretta in alluminio 40x40x45 burattato
Utilizzabile con art.745 746 748 749 751 752
Codice Art.: 3-7081



Squadretta in alluminio 45x45x90 burattato
Utilizzabile con art.745 746 748 749 751 752
Codice Art.: F-0075

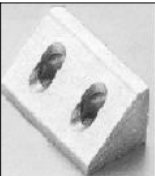
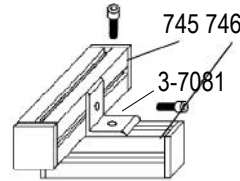

Squadretta in alluminio 40x40x90.
Utilizzabile con art.745 746 748 749 751 752
Codice Art.: 3-9081



Squadretta in alluminio 40x40x45.
Utilizzabile con art.745 752
Codice Art.: 3-8081

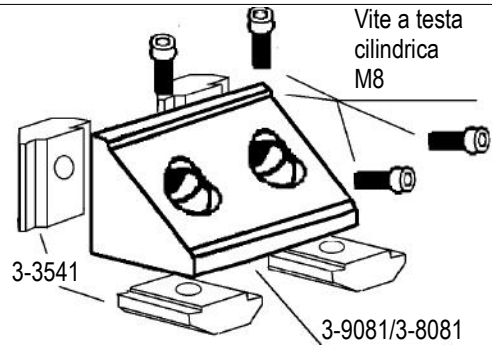

Squadretta in alluminio 80x80x45.
Utilizzabile con art.745 752
Codice Art.: 3-0181



Squadretta in alluminio 80x80x90.
Utilizzabile con art.745 752 746 748 749 751
Codice Art.: 3-1181

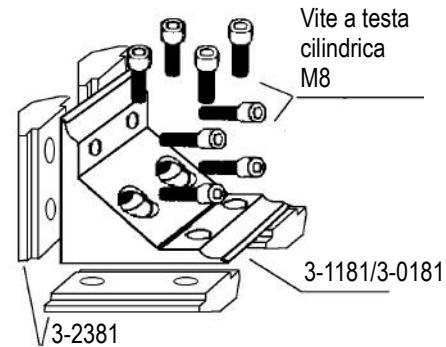

Giunto 90°

Giunto in alluminio per collegamenti a 90° a 2 o 3 vie.

- Codice Art. 3-5181 (3VIE) per profilo cava 8
- Codice Art. 3-4181 (2VIE) per profilo cava 8
- Codice Art. 3-9581 (3VIE) per profilo cava 10
- Codice Art. 3-8581 (2VIE) per profilo cava 10

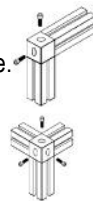

- 3-4181 (2VIE) cava 8
- 3-8581 (2VIE) cava 10

- 3-5181 (3VIE) cava 8
- 3-9581 (3VIE) cava 10



Giunto 90° a 3 vie

Giunto in per collegamenti a 90° 3 vie. Utilizzabile con Art.: 752 360 364
Codice Art.F-0063

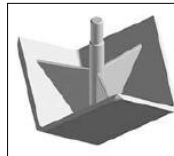

Tappo in nylon nero quadrato
Codice Art.F-0064

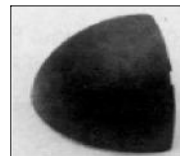

Tappo in nylon stonato nero
Cod. Art.F-0065



Piastra in alluminio

- Codice Art. F-0079 45x90 per giunzione a 90°
- Codice Art. F-0083 90x90 per collegamento



Esempio utilizzo F-0083



Esempio utilizzo F-0079

Via Newton, n.12

20016 Pero (Milano - Italy)

Tel.+39 02 3535955 r.a. Fax.+39 02 3539929

E-Mail: info@omar-alluminio.it

Cataloghi Online: www.omar-alluminio.it

www.omar-alluminio.com

PROFILATI ALLUMINIO A DISEGNO / STANDARD / SPECIALI / E PER:
ELETTRONICA / LED / FOTOVOLTAICO / AUTOMAZIONE ROBOTICA / PNEUMATICA / AUTOMOTIVE



ACCESSORI per profili componibili, banchi e linee modulari - Profili strutturali

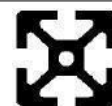

Serie 45

Gamma completa per:

-Profili in alluminio con ossidazione naturale in barre o tagliati a misura

-Accessori adatti alla realizzazione di strutture modulari (passare a pag.71 per i disegni dei profili)

Giunto in alluminio per collegamenti a 90° singolo (45x45) e doppio (45x90).

Codice Art. 3-4581 (45x45)

Codice Art. 3-5581 (45x90)

Codice Art. 3-6581 (90x90)

ISTRUZIONI PER L'UTILIZZO

FASE A) Montare la vite M8x16 e le viti M6x22 sul giunto

FASE B) Avvitare la vite M8x16 sul profilo

FASE C) Collegare il secondo profilo al giunto

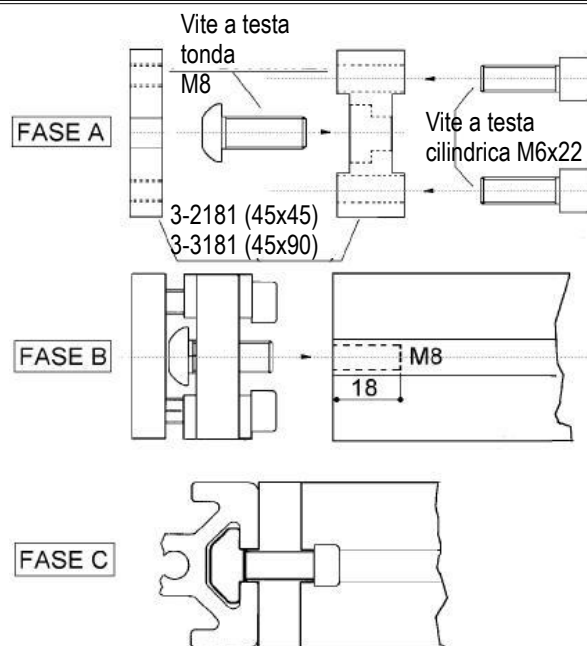
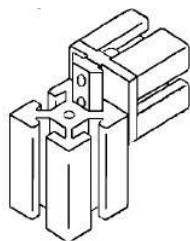

Piastrina in lamiera anti-rotazione per collegamenti 90
Codice Art.: 3-1381 per profilo cava 8
Codice Art.: 3-7581 per profilo cava 10

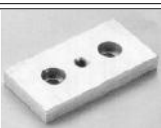
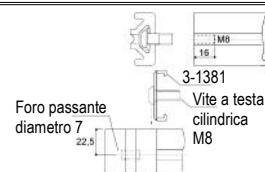
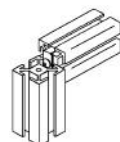

Piastra in alluminio 45x90 con foro M10
Cod. Art.3-0681



Piastra in alluminio 90x90 con foro M10
Utilizzabile con art.748 Cod. Art.3-3681



Collegamento 90° a scomparsa in acciaio zincato per serie 45
Codice Art.F-0067



Cursore alluminio lunghezza 21mm con 1 foro M8 - Codice Art.3-3081
Cursore alluminio lunghezza 21mm con 1 foro M10 - Codice Art.3-4081



Giunto in metallo 45x45 snodato con brugola per il bloccaggio.
Cod. Art.F-0017



Cursore alluminio lunghezza 65mm con 2 fori M8 interasse 45 mm
Codice Art.3-2381



Cerniera con perno diametro 7 mm
Codice Art.3-3281

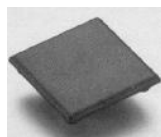

Tappo in nylon nero 45x45
Cod.Art.3-0081



Tappo in nylon nero 45x90
Cod. Art.3-1081 profilo cava 8
Cod.Art.3-1581 profilo cava 10

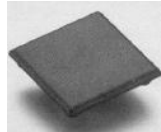

Tappo in nylon nero 90x90
Cod.Art.3-2581

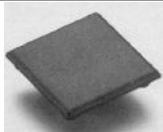

Tappo in nylon nero 90x60
Cod.Art.3-7681 profilo cava 10



Piede regolabile per profili 45x45
Codice Art.F-0059



ACCESSORI per profili componibili, banchi e linee modulari - Profili strutturali

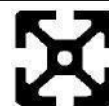

Gamma completa per:

-Profili in alluminio con ossidazione naturale in barre o tagliati a misura

-Accessori adatti alla realizzazione di strutture modulari (passare a pag.71 per i disegni dei profili)

Serie 30



Squadretta in alluminio 30x30x30. Utilizzabile con art.755 769 770 771 785 784
Codice Art.: 3-3741



Vite a testa cilindrica
3-3741



Squadretta in alluminio 30x30x60. Utilizzabile con art.328 755 756 769 770 771 785 784
Codice Art.: F-0073



Squadretta in alluminio 30x30x30. Utilizzabile con art.755 769 770 771 785 784
Cod.: 3-4741

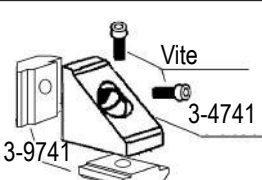

Vite
3-4741

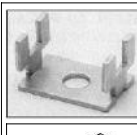

Piastrina in alluminio anti-rotazione per collegamenti 90° Cod.: 3-5741

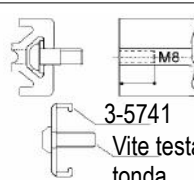

Vite testa tonda M8
3-5741

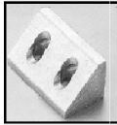

Squadretta in alluminio 30x30x60. Utilizzabile con art.328 755 756 769 770 771 785 784
Codice Art.: 3-7741

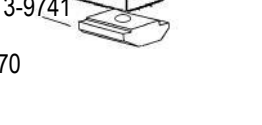

Vite
3-9741

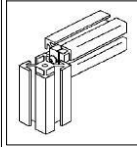

Foro passante diametro 7 per chiave esagonare

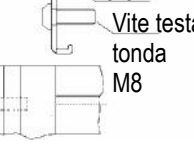

Vite testa tonda M8
15

Piastra in alluminio
Codice Art. F-0077 30x60 per giunzione a 90°
Codice Art. F-0081 60x60 per collegamento

Esempio utilizzo F-0081



Esempio utilizzo F-0077



Cursore in zama di fissaggio Utilizzabile con art.755 769 770 771 756
Codice Art.: 3-0841 1 foro M6
Codice Art.: 3-9741 1 foro M5



Cursore in acciaio zincato a 'culla' per montaggio frontale da 21 mm con sferetta
Codice Art.F-0023 1 foro M6
Codice Art.F-0022 1 foro M8.



Cursore di fissaggio in alluminio 1 foro M4
Codice Art.: 3-4841



Cursore in acciaio zincato con foro M6.
Cod. Art.3-2741 in acciaio zincato
Cod. Art.3-2741-INOX in acciaio inox



Dado testa quadra M5/M6/M8 a montaggio frontale in acciaio zincato con linguetta
Codice Art. F-0040 M5
Codice Art. F-0039 M6
Codice Art. F-0038 M8

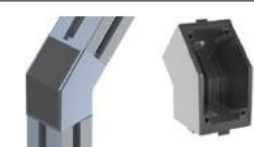

Collegamento 45° 30x30 Utilizzabile con art.755 769 770 771 785
Codice Art.: F-0062

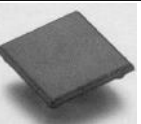

Tappo in nylon nero 30x30 Utilizzabile con art.755 769 770 771
Cod. Art.3-1741

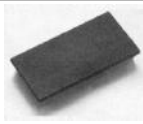

Tappo in nylon nero 30x60 Utilizzabile con art.756
Cod. Art.3-8741 Item no.: 3-8741



Reggi cavo in materiale plastico . Fissare al profilo utilizzando 3-3331 F-0028 etc. Cod.Art.F-0018



Giunto in zinco pressofuso a 90° a 3 vie . Utilizzabile con Art.: 755 769 770 771 785
Codice Art.F-0001



Tappo in plastica nera per giunto 3 vie . Utilizzabile con Art.: F-0001
Codice Art.F-0002

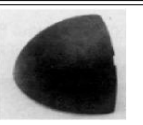

Tappo in plastica nera stonato per giunto 3 vie . Utilizzabile con Art.: F-0001
Codice Art.F-0008



Giunto in metallo 30x30 con snodo e brugola di bloccaggio. Utilizzabile con art.755 769 770 771 784 785 756
Codice Art.: F-0011

Via Newton, n.12
20016 Pero (Milano - Italy)
Tel.+39 02 3535955 r.a. Fax.+39 02 3539929
E-Mail: info@omar-alluminio.it

Cataloghi Online: www.omar-alluminio.it
www.omar-alluminio.com

PROFILATI ALLUMINIO A DISEGNO / STANDARD / SPECIALI / E PER:
ELETTRONICA / LED / FOTOVOLTAICO / AUTOMAZIONE ROBOTICA / PNEUMATICA / AUTOMOTIVE



ACCESSORI per profili componibili, banchi e linee modulari - Profili strutturali

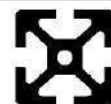

Gamma completa per:

-Profili in alluminio con ossidazione naturale in barre o tagliati a misura

-Accessori adatti alla realizzazione di strutture modulari (passare a pag.71 per i disegni dei profili)

Serie 30

 <p>Morsetto con cuscinetti in gomma per pannelli o vetri spessore 2-10mm Cod. Art.: F-0014</p>	 <p>Giunzione 90° per porta pannello F-0014 Cod. Art.: F-0015</p>
 <p>Piede regolabile per profili 30x30 Codice Art.F-0057</p>	 <p>Reggicavo (materiale plastico) Codice Art.F-0060</p>
 <p>Cerniera con inserto M5 interasse 31 Codice Art.3-2021</p>	 <p>Cerniera alluminio interasse 32 mm Codice Art.3-7331</p>
 <p>Cursore a martello in acciaio zincato filettato M6x30 Codice Art. F-0025</p>	 <p>Collegamento 90° a scomparsa in acciaio zincato per serie 30 Codice Art.F-0067</p>
 <p>Piastra in alluminio per ancoraggio a terra 30x60 con foro M8 art.3-6741 Utilizzabile con art.755 756</p>	 <p>Giunto in alluminio per collegamenti a 90° a 2 o 3 vie 30x30. Codice Art.F-0007 GIUNTO 2 VIE Codice Art.F-0055 GIUNTO 3 VIE</p>

Cataloghi Online: www.omar-alluminio.it
www.omar-alluminio.com

PROFILATI ALLUMINIO A DISEGNO / STANDARD / SPECIALI / E PER:
ELETTRONICA / LED / FOTOVOLTAICO / AUTOMAZIONE ROBOTICA / PNEUMATICA / AUTOMOTIVE

Via Newton, n.12
20016 Pero (Milano - Italy)
Tel.+39 02 3535955 r.a. Fax.+39 02 3539929
E.Mai: info@omar-alluminio.it

OMAR s.r.l.
PROFILATI ALLUMINIO
ALTA TECNOLOGIA

ACCESSORI per profili componibili, banchi e linee modulari - Profili strutturali

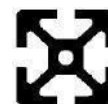

Gamma completa per:

-Profili in alluminio con ossidazione naturale in barre o tagliati a misura

-Accessori adatti alla realizzazione di strutture modulari (passare a pag.71 per i disegni dei profili)

Serie 20

	<p>Squadretta in alluminio 40x40x20. Utilizzabile con art.735 736 737 Codice Art.: 3-9531</p> <p>Squadretta in alluminio 20x20x20. Utilizzabile con art.735 736 737 Codice Art.: F-0084</p>	<p>Vite a testa cilindrica 3-9531 F-0084</p> <p>3-4331</p>	<p>Morsetto con cuscinetti in gomma per pannelli o vetri spessore 2-10mm Cod. Art.: F-0014</p>
	<p>Squadretta in alluminio 40x40x20. Material: aluminium.Utilizzabile con art.735 736 737 Codice Art.: 3-7431</p>	<p>Vite a testa cilindrica 3-7431</p> <p>3-3331</p>	<p>Giunzione 90° per porta pannello F-0014 Cod. Art.: F-0015</p>
<p>Giunto in alluminio per collegamenti a 90° a 2 vie 20X20 con tappi .Codice Art.F-0051</p>	<p>Giunto in alluminio per collegamenti a 90° a 3 vie 20X20 con tappi. Codice Art.F-0052</p>		
<p>Piastrina di fissaggio in acciaio Utilizzabile con art.735 736 737 Codice Art.: 3-3331 1 foro M4 Codice Art.: 3-4331 1 foro M5</p>	<p>Cursore in acciaio zincato a 'culla' per montaggio frontale da 12 mm con sferetta. Codice Art.F-0026 1 foro M3 Codice Art.F-0027 1 foro M4 Codice Art.F-0028 1 foro M5</p>		
<p>Giunto in per collegamenti a 90° a 3 vie. Codice Art. F-0068</p>	<p>Tappo in nylon nero quadrato per giunto 3vie Codice Art.F-0069</p>		
<p>Giunto in alluminio 20x20 con snodo e brugola di bloccaggio. Codice Art.: F-0056</p>	<p>Reggi cavo in materiale plastico . Cod.Art.F-0018</p> <p>Tappo in nylon nero 20x20. Utilizzabile con art.735 736 737 Cod. Art.3-1631</p>		

Accessori per profili componibili modulari

Per i disegni dei profili in alluminio andare a pag. 79



<p>Esempio di utilizzo</p> <p>724/725 3-0121 3-9021 3-6121 724/725 716</p>	<p>Giunzione 90° a 2 vie in Nylon Cod. 3-0121 da utilizzare con art. 3-9021 724 725 722</p>	<p>Collegamento in Nylon Cod. 3-9021 da utilizzare con art. 3-0121 3-5121 3-7121</p>
<p>Esempio di utilizzo</p> <p>3-8321 3-9321 721 723</p>	<p>Giunzione a 2 vie in alluminio Cod 3-8321 da utilizzare con art. 721 723</p>	<p>Giunzione a 3 vie in alluminio Cod 3-9321 da utilizzare con art. 721 723</p>
<p>Giunzione 90° a 3 vie in Nylon Cod. 3-5121 da utilizzare con art. 3-9021 722 724 725</p>	<p>Giunzione 135° a 3 vie in Nylon Cod. 3-6121 da utilizzare con art. 3-9021 716</p>	
<p>Terminale in Nylon Cod. 3-7121 da utilizzare con art.3-9021 722 724 725</p>	<p>Terminale in Nylon con inserto M8 Cod.3-1421 da utilizzare con art. 3-9021 722 724 725</p>	

Via Newton, n.12
20016 Pero (Milano - Italy)
Tel.+39 02 3539929
E-Mail: info@omar-alluminio.it

Cataloghi Online: www.omar-alluminio.it
www.omar-alluminio.com
PROFILATI ALLUMINIO A DISEGNO / STANDARD / SPECIALI / E PER:
ELETTRONICA / LED / FOTOVOLTAICO / AUTOMAZIONE ROBOTICA / PNEUMATICA / AUTOMOTIVE



Accessori per profili Stand

Per i profili passare a pag.70



Via Newton, n.12
20016 Pero (Milano - Italy)
Tel. +39 02 3535955 r.a. Fax. +39 02 3539929
E-Mail: info@omar-alluminio.it

Cataloghi Online: www.omar-alluminio.it
www.omar-alluminio.com

PROFILATI ALLUMINIO A DISEGNO / STANDARD / SPECIALI / E PER:
ELETTRONICA / LED / FOTOVOLTAICO / AUTOMAZIONE ROBOTICA / PNEUMATICA / AUTOMOTIVE

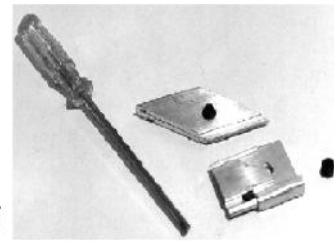
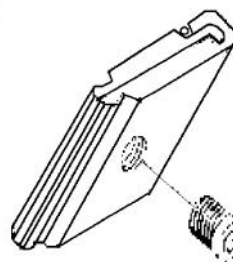
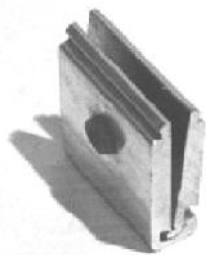
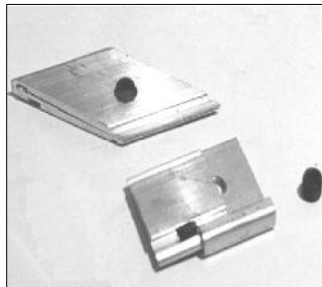

Cod. Art.	Item no.	Descrizione
S-GT40		Giunto in alluminio brevettato per collegamenti a 90°. Art.1001 1002.
S-GT60		Giunto in alluminio brevettato per collegamenti a 90°. Utilizzabile per Art.1000 1002 1003 1004 1008.

Giunti in alluminio brevettati ad alto grado di serraggio, con grani M10 disponibili anche per collegamenti a 30° 60° 45° o secondo Vs. Specifiche

Traverse curvate

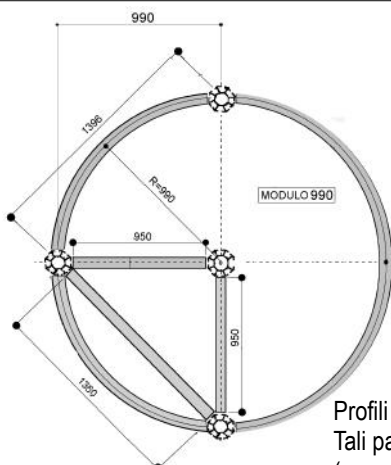
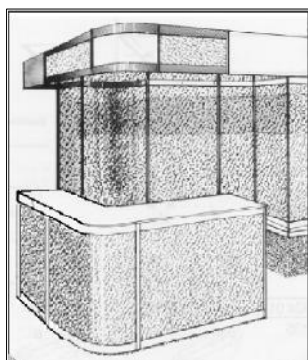

Curve per moduli da 1Mt o da 1/2 Mt (da effettuare su Art.1000 1001)

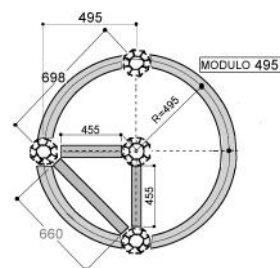

Profili curvati e traverse per la realizzazione di moduli da 1mt o 1/2 mt. Tali particolari sono fornibili grezzi, anodizzati (nero o bianco) o verniciati.

-RIPRODUZIONE VIETATA-
AGGIORNAMENTO CONTINUO
- ED. DEL 02-2017

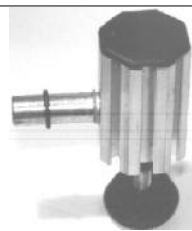

Perno reggi ripiano

Perno reggi ripiano in metallo zincato con fissaggio rapido al profilo guarnizione di protezione dello stesso e guarnizione in gomma. Da utilizzare con Art. 1000 1001 1002 1006 1008 1013 Codice articolo: S-NOTT

S-PM10

S-RTM10

Piede e rotella



Piede e rotella in plastica nera per tappo M10.

Codice Art.: S-PM10
S-RTM10



Tappi filettati in plastica

Tappo in plastica nera filettato M10 per il montaggio di rotelle piedi etc..Da utilizzare con Art. 1002 1008 1013 PM10 RTM10
Codice articolo: S-TPM10 per art.1002 1008
S-TPM10-1 per art.1013

Supporto reggi cavi



Reggi cavo in materiale plastico . Fissare al profilo utilizzando S-PIAP F-0018 etc. Cod.Art.F-0018

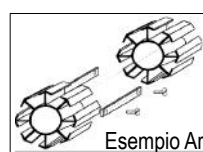

Esempio Art. S-PIAG

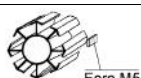

Esempio Art. S-PIAP

Foro M5
M5 Hole

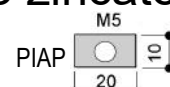
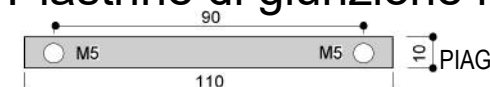

Piastrine di giunzione per art. 1002 1008 1013 Codice articolo: S-PIAG
Piastrine di fissaggio accessori con filetto M5 Codice articolo: S-PIAG



Morsetto con cuscinetti in gomma per pannelli o vetri spessore 2-10mm
Cod. Art.: F-0014

Porta Vetri



Giunzione 90° per porta pannello F-0014
Cod. Art.: F-0015



S-TPON S-TPOB
Per art. 1002

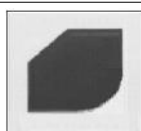

S-TPAN S-TPAB
Per art. 1008

Tappi di finitura n plastica di colore nero o bianco.
Codice art. S-TPON (nero) S-TPOB (bianco)
S-TPAN (nero) S-TPAB (bianco)
S-TPEN (nero) S-TPEB (bianco)



Consultate il Catalogo aggiornato Online
all'indirizzo www.omar-alluminio.it

Indice Articoli

COD.	TIPO ARTICOLO	PAG	COD.	TIPO ARTICOLO	PAG	COD.	TIPO ARTICOLO	PAG
100	DISSIPATORE	62	315	PROFILI FOTOVOLTAICO	103	402	DISSIPATORE	4
101	DISSIPATORE	62	316	PROFILI FOTOVOLTAICO	103	403	DISSIPATORE	4
103	DISSIPATORE	62	317	PROFILI FOTOVOLTAICO	103	404	DISSIPATORE	4
104	DISSIPATORE	62	318	PROFILI FOTOVOLTAICO	97	405	DISSIPATORE	4
105	DISSIPATORE	62	320	PROFILI FOTOVOLTAICO	98	406	DISSIPATORE	4
106	DISSIPATORE	62	321	PROFILI FOTOVOLTAICO	96	408	DISSIPATORE	5
108	DISSIPATORE	62	322	PROFILI FOTOVOLTAICO	96	409	DISSIPATORE	5
109	DISSIPATORE	62	323	PROFILI FOTOVOLTAICO	96	410	DISSIPATORE	5
110	DISSIPATORE	62	324	PROFILI FOTOVOLTAICO	96	411	DISSIPATORE	5
111	DISSIPATORE	62	325	PROFILI FOTOVOLTAICO	96	412	DISSIPATORE	5
112	DISSIPATORE	62	326	PROFILI FOTOVOLTAICO	97	413	DISSIPATORE	4
113	DISSIPATORE	62	328	PROFILI COM PONIBILI	65	414	DISSIPATORE	53
117	DISSIPATORE	62	329	PROFILI FOTOVOLTAICO	97	415	DISSIPATORE	5
121	DISSIPATORE	62	330	PROFILI COM PONIBILI	67	416	DISSIPATORE	5
122	DISSIPATORE	62	331	PROFILI FOTOVOLTAICO	99	419	DISSIPATORE	4
123	DISSIPATORE	62	332	PROFILI FOTOVOLTAICO	93	420	DISSIPATORE	53
124	DISSIPATORE	62	333	PROFILI FOTOVOLTAICO	70	421	DISSIPATORE	5
130	DISSIPATORE	62	335	PROFILI FOTOVOLTAICO	70	423	DISSIPATORE	4
134	DISSIPATORE	62	336	PROFILI FOTOVOLTAICO	101	424	DISSIPATORE	53
135	DISSIPATORE	62	337	PROFILI FOTOVOLTAICO	91	427	DISSIPATORE	50
144	DISSIPATORE	62	338	PROFILI FOTOVOLTAICO	92	428	DISSIPATORE	57
146	DISSIPATORE	62	339	PROFILI FOTOVOLTAICO	92	429	DISSIPATORE	11
147	DISSIPATORE	62	340	PROFILI FOTOVOLTAICO	92	430	DISSIPATORE	12
149	DISSIPATORE	62	345	PROFILI COM PONIBILI	69	432	DISSIPATORE	11
160	DISSIPATORE	61	346	PROFILI FOTOVOLTAICO	103	433	DISSIPATORE	14
161	DISSIPATORE	61	347	PROFILI FOTOVOLTAICO	103	434	DISSIPATORE	21
162	DISSIPATORE	61	348	PROFILI FOTOVOLTAICO	103	438	DISSIPATORE	9
163	DISSIPATORE	61	349	PROFILI FOTOVOLTAICO	96	439	DISSIPATORE	10
164	DISSIPATORE	61	351	PROFILI FOTOVOLTAICO	97	440	DISSIPATORE	11
165	DISSIPATORE	61	352	PROFILI FOTOVOLTAICO	97	441	DISSIPATORE	7
166	DISSIPATORE	61	355	PROFILI FOTOVOLTAICO	98	442	DISSIPATORE	5
167	DISSIPATORE	61	356	PROFILI FOTOVOLTAICO	98	443	DISSIPATORE	10
168	DISSIPATORE	61	357	PROFILI COM PONIBILI	66	444	DISSIPATORE	9
169	DISSIPATORE	61	358	PROFILI COM PONIBILI	66	445	DISSIPATORE	19
170	DISSIPATORE	61	359	PROFILI FOTOVOLTAICO	70	446	DISSIPATORE	5
171	DISSIPATORE	61	360	PROFILI COM PONIBILI	69	447	DISSIPATORE	4
180	DISSIPATORE	61	361	PROFILI COM PONIBILI	69	449	DISSIPATORE	5
188	DISSIPATORE	61	362	PROFILI COM PONIBILI	69	450	DISSIPATORE	28
189	DISSIPATORE	61	363	PROFILI COM PONIBILI	69	451	DISSIPATORE	29
190	DISSIPATORE	61	364	PROFILI COM PONIBILI	69	452	DISSIPATORE	30
195	DISSIPATORE	61	365	PROFILI COM PONIBILI	69	453	DISSIPATORE	28
238	DISSIPATORE	63	366	PROFILI COM PONIBILI	69	454	DISSIPATORE	30
239	DISSIPATORE	63	367	PROFILI COM PONIBILI	69	455	DISSIPATORE	33
240	DISSIPATORE	63	368	PROFILI FOTOVOLTAICO	99	456	DISSIPATORE	40
241	DISSIPATORE	63	369	PROFILI FOTOVOLTAICO	99	457	DISSIPATORE	43
243	DISSIPATORE	63	370	PROFILI FOTOVOLTAICO	99	458	DISSIPATORE	28
244	DISSIPATORE	63	371	PROFILI COM PONIBILI	74	459	DISSIPATORE	29
246	DISSIPATORE	63	372	PROFILI COM PONIBILI	75	460	DISSIPATORE	34
247	DISSIPATORE	63	373	PROFILI COM PONIBILI	76	461	DISSIPATORE	46
248	DISSIPATORE	63	374	PROFILI COM PONIBILI	77	462	DISSIPATORE	31
249	DISSIPATORE	63	375	PROFILI COM PONIBILI	78	463	DISSIPATORE	30
250	DISSIPATORE	63	376	PROFILI COM PONIBILI	74	464	DISSIPATORE	31
251	DISSIPATORE	61	377	PROFILI COM PONIBILI	75	465	DISSIPATORE	34
252	DISSIPATORE	61	378	PROFILI FOTOVOLTAICO	97	466	DISSIPATORE	41
254	DISSIPATORE	61	379	PROFILI FOTOVOLTAICO	98	467	DISSIPATORE	44
271	DISSIPATORE	63	380	PROFILI FOTOVOLTAICO	92	468	DISSIPATORE	49
272	DISSIPATORE	63	381	PROFILI FOTOVOLTAICO	92	469	DISSIPATORE	50
300	PROFILI SPECIALI	130	382	PROFILI FOTOVOLTAICO	98	470	DISSIPATORE	44
301	PROFILI SPECIALI	130	383	PROFILI FOTOVOLTAICO	97	471	DISSIPATORE	42
302	PROFILI SPECIALI	130	384	PROFILI FOTOVOLTAICO	97	472	DISSIPATORE	45
303	PROFILI SPECIALI	130	385	PROFILI FOTOVOLTAICO	99	473	DISSIPATORE	46
304	PROFILI COM PONIBILI	66	386	PROFILI FOTOVOLTAICO	92	474	DISSIPATORE	45
305	PROFILI COM PONIBILI	70	387	PROFILI FOTOVOLTAICO	92	475	DISSIPATORE	33
306	PROFILI COM PONIBILI	65	388	PROFILI FOTOVOLTAICO	101	476	DISSIPATORE	32
307	PROFILI COM PONIBILI	65	389	PROFILI FOTOVOLTAICO	103	477	DISSIPATORE	29
309	PROFILI FOTOVOLTAICO	103	390	PROFILI FOTOVOLTAICO	98	478	DISSIPATORE	47
310	PROFILI SPECIALI	74	391	PROFILI FOTOVOLTAICO	95	479	DISSIPATORE	40
311	PROFILI SPECIALI	74	392	PROFILI FOTOVOLTAICO	95	480	DISSIPATORE	35
313	PROFILI FOTOVOLTAICO	94	400	DISSIPATORE	4	481	DISSIPATORE	38
314	PROFILI FOTOVOLTAICO	103	401	DISSIPATORE	4	482	DISSIPATORE	39

Cataloghi Online: www.omar-alluminio.it

www.omar-alluminio.com

PROFILATI ALLUMINIO A DISEGNO / STANDARD / SPECIALI / E PER:

ELETRONICA / LED / FOTOVOLTAICO / AUTOMAZIONE ROBOTICA / PNEUMATICA / AUTOMOTIVE



Via Newton, n.12

20016 Pero (Milano - Italy)

Tel. +39 02 3535955 r.a. Fax. +39 02 3539929

E-Mail: info@omar-alluminio.it

Via Newton, n. 12
20016 Pero (Milano - Italy)
Tel. +39 02 3535955 r.a. Fax. +39 02 3539929
E-Mail: info@omar-alluminio.it

Cataloghi Online: www.omar-alluminio.it
www.omar-alluminio.com
PROFILATI ALLUMINIO A DISEGNO / STANDARD / SPECIALI / E PER:
ELETTRONICA / LED / FOTOVOLTAICO / AUTOMAZIONE ROBOTICA / PNEUMATICA / AUTOMOTIVE



Indice Articoli

Consultate il Catalogo aggiornato Online
all'indirizzo www.omar-alluminio.it

483	DISSIPATORE	37	707	PROFILI FOTOVOLTAICO	103	782	PROFILI FOTOVOLTAICO	103
484	DISSIPATORE	36	708	PROFILI COMPONIBILI	68	783	PROFILI FOTOVOLTAICO	103
485	DISSIPATORE	42	709	PROFILI COMPONIBILI	68	784	PROFILI COMPONIBILI	65
486	DISSIPATORE	32	710	PROFILI COMPONIBILI	68	785	PROFILI COMPONIBILI	65
487	DISSIPATORE	36	711	PROFILI COMPONIBILI	68	786	PROFILI COMPONIBILI	68
489	DISSIPATORE	37	713	PROFILI FOTOVOLTAICO	101	787	PROFILI FOTOVOLTAICO	70
490	DISSIPATORE	48	715	PROFILI COMPONIBILI	73	788	PROFILI FOTOVOLTAICO	94
491	DISSIPATORE	41	716	PROFILI COMPONIBILI	73	789	PROFILI COMPONIBILI	65
492	DISSIPATORE	38	717	PROFILI COMPONIBILI	73	792	PROFILI FOTOVOLTAICO	98
493	DISSIPATORE	39	718	PROFILI COMPONIBILI	73	793	PROFILI FOTOVOLTAICO	101
494	DISSIPATORE	43	719	PROFILI COMPONIBILI	73	794	PROFILI FOTOVOLTAICO	103
495	DISSIPATORE	47	720	PROFILI COMPONIBILI	73	794/1	PROFILI FOTOVOLTAICO	103
496	DISSIPATORE	48	721	PROFILI COMPONIBILI	73	796	PROFILI COMPONIBILI	70
497	DISSIPATORE	49	722	PROFILI COMPONIBILI	73	797	PROFILI FOTOVOLTAICO	70
500	DISSIPATORE	6	723	PROFILI COMPONIBILI	73	798	PROFILI COMPONIBILI	69
503	DISSIPATORE	7	724	PROFILI COMPONIBILI	73	799	PROFILI FOTOVOLTAICO	97
505	DISSIPATORE	8	725	PROFILI COMPONIBILI	73	801	DISSIPATORE	4
513	DISSIPATORE	10	726	PROFILI COMPONIBILI	67	802	DISSIPATORE	4
525	DISSIPATORE	13	727	PROFILI COMPONIBILI	67	803	DISSIPATORE	12
526	DISSIPATORE	6	729	PROFILI COMPONIBILI	67	804	DISSIPATORE	15
527	DISSIPATORE	57	730	PROFILI COMPONIBILI	66	805	DISSIPATORE	12
528	DISSIPATORE	57	731	PROFILI COMPONIBILI	66	806	DISSIPATORE	4
529	DISSIPATORE	9	732	PROFILI COMPONIBILI	66	807	DISSIPATORE	4
530	DISSIPATORE	12	733	PROFILI COMPONIBILI	66	808	DISSIPATORE	5
531	DISSIPATORE	7	734	PROFILI COMPONIBILI	66	809	DISSIPATORE	6
532	DISSIPATORE	10	735	PROFILI COMPONIBILI	65	810	DISSIPATORE	6
533	DISSIPATORE	57	736	PROFILI COMPONIBILI	65	811	DISSIPATORE	5
534	DISSIPATORE	57	737	PROFILI COMPONIBILI	65	812	DISSIPATORE	6
537	DISSIPATORE	7	738	PROFILI FOTOVOLTAICO	91	813	DISSIPATORE	8
545	DISSIPATORE	7	739	PROFILI COMPONIBILI	66	814	DISSIPATORE	12
600	DISSIPATORE	52	740	PROFILI COMPONIBILI	66	815	DISSIPATORE	7
601	DISSIPATORE	52	741	PROFILI COMPONIBILI	67	816	DISSIPATORE	8
602	DISSIPATORE	52	742	PROFILI COMPONIBILI	67	817	DISSIPATORE	8
603	DISSIPATORE	51	743	PROFILI COMPONIBILI	67	818	DISSIPATORE	9
604	DISSIPATORE	52	745	PROFILI COMPONIBILI	66	819	DISSIPATORE	9
605	DISSIPATORE	52	746	PROFILI COMPONIBILI	65	820	DISSIPATORE	9
608	DISSIPATORE	51	747	PROFILI COMPONIBILI	66	821	DISSIPATORE	24
610	DISSIPATORE	51	748	PROFILI COMPONIBILI	68	822	DISSIPATORE	15
611	DISSIPATORE	51	749	PROFILI COMPONIBILI	68	823	DISSIPATORE	10
613	DISSIPATORE	51	750	PROFILI COMPONIBILI	66	824	DISSIPATORE	15
617	DISSIPATORE	7	751	PROFILI COMPONIBILI	68	825	DISSIPATORE	10
618	DISSIPATORE	7	752	PROFILI COMPONIBILI	68	826	DISSIPATORE	14
619	DISSIPATORE	51	753	PROFILI COMPONIBILI	67	827	DISSIPATORE	11
620	DISSIPATORE	50	754	PROFILI COMPONIBILI	66	828	DISSIPATORE	11
621	DISSIPATORE	51	755	PROFILI COMPONIBILI	65	829	DISSIPATORE	12
622	DISSIPATORE	20	756	PROFILI COMPONIBILI	65	830	DISSIPATORE	12
624	DISSIPATORE	15	757	PROFILI COMPONIBILI	65	831	DISSIPATORE	8
626	DISSIPATORE	51	758	PROFILI FOTOVOLTAICO	101	832	DISSIPATORE	8
629	DISSIPATORE	10	759	PROFILI COMPONIBILI	66	833	DISSIPATORE	6
633	DISSIPATORE	50	760	PROFILI COMPONIBILI	65	834	DISSIPATORE	6
634	DISSIPATORE	17	761	PROFILI COMPONIBILI	72	835	DISSIPATORE	16
637	DISSIPATORE	52	762	PROFILI COMPONIBILI	72	836	DISSIPATORE	22
638	DISSIPATORE	52	763	PROFILI COMPONIBILI	72	837	DISSIPATORE	6
639	DISSIPATORE	52	764	PROFILI COMPONIBILI	72	838	DISSIPATORE	13
640	DISSIPATORE	53	765	PROFILI COMPONIBILI	72	839	DISSIPATORE	6
641	DISSIPATORE	53	766	PROFILI COMPONIBILI	72	841	DISSIPATORE	4
642	DISSIPATORE	52	767	PROFILI COMPONIBILI	69	842	DISSIPATORE	9
645	DISSIPATORE	54	768	PROFILI COMPONIBILI	72	843	DISSIPATORE	8
646	DISSIPATORE	55	769	PROFILI COMPONIBILI	65	844	DISSIPATORE	12
647	DISSIPATORE	9	770	PROFILI COMPONIBILI	65	845	DISSIPATORE	9
648	DISSIPATORE	51	771	PROFILI COMPONIBILI	65	846	DISSIPATORE	14
649	DISSIPATORE	6	772	PROFILI FOTOVOLTAICO	72	847	DISSIPATORE	9
650	DISSIPATORE	6	773	PROFILI FOTOVOLTAICO	72	848	DISSIPATORE	12
651	DISSIPATORE	4	774	PROFILI COMPONIBILI	72	849	DISSIPATORE	10
652	DISSIPATORE	21	775	PROFILI COMPONIBILI	68	850	DISSIPATORE	13
653	DISSIPATORE	10	776	PROFILI COMPONIBILI	66	851	DISSIPATORE	10
654	DISSIPATORE	53	777	PROFILI COMPONIBILI	66	852	DISSIPATORE	15
700	PROFILI FOTOVOLTAICO	92	778	PROFILI COMPONIBILI	68	853	DISSIPATORE	16
703	PROFILI FOTOVOLTAICO	94	779	PROFILI COMPONIBILI	68	855	DISSIPATORE	20
705	PROFILI FOTOVOLTAICO	101	780	PROFILI COMPONIBILI	68	856	DISSIPATORE	8
706	PROFILI FOTOVOLTAICO	103	781	PROFILI FOTOVOLTAICO	103	857	DISSIPATORE	8

Consultate il Catalogo aggiornato Online
all'indirizzo www.omar-alluminio.it

Indice Articoli

858	DISSIPATORE	9	940	DISSIPATORE	14	1205	PROFILI SPECIALI	123
863	DISSIPATORE	8	944	DISSIPATORE	8	1206	PROFILI SPECIALI	123
865	DISSIPATORE	22	945	DISSIPATORE	7	1207	PROFILI SPECIALI	123
867	DISSIPATORE	9	946	DISSIPATORE	22	1208	PROFILI SPECIALI	123
869	DISSIPATORE	9	947	DISSIPATORE	18	1209	PROFILI SPECIALI	123
871	DISSIPATORE	24	948	DISSIPATORE	18	1210	PROFILI SPECIALI	123
872	DISSIPATORE	18	950	DISSIPATORE	19	1211	PROFILI SPECIALI	123
873	DISSIPATORE	20	951	DISSIPATORE	8	1212	PROFILI SPECIALI	123
874	DISSIPATORE	21	952	DISSIPATORE	21	1213	PROFILI SPECIALI	123
875	DISSIPATORE	20	953	PROFILI SPECIALI	109	1214	PROFILI SPECIALI	123
876	DISSIPATORE	23	956	DISSIPATORE	16	1300	PROFILI SPECIALI	106
879	DISSIPATORE	17	958	DISSIPATORE	20	1302	PROFILI SPECIALI	106
880	DISSIPATORE	17	959	DISSIPATORE	12	1303	PROFILI SPECIALI	106
881	DISSIPATORE	16	960	DISSIPATORE	18	1306	PROFILI SPECIALI	106
882	DISSIPATORE	7	961	DISSIPATORE	28	1308	PROFILI SPECIALI	106
883	DISSIPATORE	6	962	DISSIPATORE	23	1309	PROFILI SPECIALI	106
884	DISSIPATORE	6	963	DISSIPATORE	7	1312	PROFILI SPECIALI	106
885	DISSIPATORE	13	965	DISSIPATORE	4	1313	PROFILI SPECIALI	106
886	DISSIPATORE	10	967	DISSIPATORE	13	1315	PROFILI SPECIALI	106
887	DISSIPATORE	13	968	DISSIPATORE	13	1321	PROFILI SPECIALI	106
888	DISSIPATORE	6	969	DISSIPATORE	53	1322	PROFILI SPECIALI	106
889	DISSIPATORE	11	970	DISSIPATORE	10	1323	PROFILI SPECIALI	106
890	DISSIPATORE	9	971	DISSIPATORE	11	1324	PROFILI SPECIALI	106
891	DISSIPATORE	14	972	DISSIPATORE	4	1325	PROFILI SPECIALI	106
892	DISSIPATORE	8	973	DISSIPATORE	19	1326	PROFILI SPECIALI	106
893	DISSIPATORE	6	974	DISSIPATORE	16	1328	PROFILI SPECIALI	106
894	DISSIPATORE	19	975	DISSIPATORE	4	1329	PROFILI SPECIALI	106
895	DISSIPATORE	11	976	DISSIPATORE	19	1330	PROFILI SPECIALI	106
896	DISSIPATORE	15	977	DISSIPATORE	60	1333	PROFILI SPECIALI	106
897	DISSIPATORE	20	978	DISSIPATORE	10	1338	PROFILI SPECIALI	106
898	DISSIPATORE	14	979	DISSIPATORE	23	1400	PROFILI RACLE	120
899	DISSIPATORE	21	980	DISSIPATORE	25	1403	PROFILI RACLE	120
900	DISSIPATORE	11	981	DISSIPATORE	25	1404	PROFILI RACLE	120
901	DISSIPATORE	15	982	DISSIPATORE	26	1405	PROFILI RACLE	120
902	DISSIPATORE	21	983/N	DISSIPATORE	11	1407	PROFILI RACLE	120
903	DISSIPATORE	11	984	DISSIPATORE	17	1408	PROFILI RACLE	120
904	DISSIPATORE	12	985	DISSIPATORE	12	1409	PROFILI RACLE	120
905	DISSIPATORE	12	986	DISSIPATORE	26	1412	PROFILI RACLE	120
906	DISSIPATORE	8	987	DISSIPATORE	26	1413	PROFILI RACLE	120
907	DISSIPATORE	9	988	DISSIPATORE	27	1416	PROFILI RACLE	120
908	DISSIPATORE	59	989	DISSIPATORE	27	1417	PROFILI RACLE	120
909	DISSIPATORE	6	990	DISSIPATORE	27	1418	PROFILI RACLE	121
910	DISSIPATORE	24	991	DISSIPATORE	27	1419	PROFILI RACLE	121
911	DISSIPATORE	16	992	DISSIPATORE	25	1420	PROFILI RACLE	120
912	DISSIPATORE	14	993	DISSIPATORE	26	1421	PROFILI RACLE	121
913	DISSIPATORE	52	994	DISSIPATORE	22	1422	PROFILI RACLE	121
914	DISSIPATORE	7	996	DISSIPATORE	21	1424	PROFILI SPECIALI	120
915	DISSIPATORE	6	997	DISSIPATORE	9	1425	PROFILI SPECIALI	121
916	DISSIPATORE	8	998	DISSIPATORE	15	1429	PROFILI RACLE	120
917	DISSIPATORE	60	999	DISSIPATORE	12	1621	PROFILI SPECIALI	107
918	DISSIPATORE	24	1000	PROFILI STAND	64	1824	PROFILI SPECIALI	107
919	DISSIPATORE	6	1001	PROFILI STAND	64	2003	PROFILI SPECIALI	117
920	DISSIPATORE	19	1002	PROFILI STAND	64	2005	CONTENITORE ELETTRONICA	3
921	DISSIPATORE	9	1005	PROFILI STAND	64	2012	PROFILI SPECIALI	125
922	DISSIPATORE	60	1008	PROFILI STAND	64	2015	PROFILI RACLE	120
923	DISSIPATORE	60	1013	PROFILI STAND	64	2017	DISSIPATORE	55
924	DISSIPATORE	16	1100	PROFILI SPECIALI	124	2019	PROFILI SPECIALI	119
925	DISSIPATORE	18	1101	PROFILI SPECIALI	124	2021	PROFILI SPECIALI	109
926	DISSIPATORE	22	1102	PROFILI SPECIALI	124	2022	PROFILI SPECIALI	109
927	DISSIPATORE	22	1103	PROFILI SPECIALI	124	2024	PROFILI SPECIALI	109
928	DISSIPATORE	16	1104	PROFILI SPECIALI	124	2028	CONTENITORE ELETTRONICA	2
929	DISSIPATORE	18	1105	PROFILI SPECIALI	124	2031	PROFILI RACLE	120
930	DISSIPATORE	23	1106	PROFILI SPECIALI	124	2036	DISSIPATORE	5
931	DISSIPATORE	10	1107	PROFILI SPECIALI	124	2040	PROFILI SPECIALI	111
932	DISSIPATORE	17	1108	PROFILI SPECIALI	124	2041	PROFILI COMPONIBILI	72
933	DISSIPATORE	20	1109	PROFILI SPECIALI	124	2042	PROFILI COMPONIBILI	72
934	DISSIPATORE	6	1110	PROFILI SPECIALI	124	2043	PROFILI COMPONIBILI	72
936	DISSIPATORE	12	1200	PROFILI SPECIALI	123	2047	DISSIPATORE	3
937	DISSIPATORE	16	1201	PROFILI SPECIALI	123	2048	DISSIPATORE	3
938	DISSIPATORE	8	1203	PROFILI SPECIALI	123	2049	DISSIPATORE	59
939	DISSIPATORE	8	1204	PROFILI SPECIALI	123	2052	CONTENITORE ELETTRONICA	3

Via Newton, n.12
20016 Pero (Milano - Italy)
Tel. +39 02 3535955 r.a. Fax. +39 02 3539929
E-Mail: info@omar-alluminio.it

Cataloghi Online: www.omar-alluminio.it
www.omar-alluminio.com

PROFILATI ALLUMINIO A DISEGNO / STANDARD / SPECIALI / E PER:
ELETTRONICA / LED / FOTOVOLTAICO / AUTOMAZIONE ROBOTICA / PNEUMATICA / AUTOMOTIVE



Consultate il Catalogo aggiornato Online
 all'indirizzo www.omar-alluminio.it

Indice Articoli

2058	PROFILI SPECIALI	130	2260	DISSIPATORE	8	3020	PROFILI SPECIALI	119
2065	CONTENITORE ELETTRONICA	2	2266	DISSIPATORE	6	3021	PROFILI SPECIALI	119
2066	PROFILI SPECIALI	118	2271	DISSIPATORE	55	3022	PROFILI SPECIALI	119
2069	PROFILI FOTOVOLTAICO	94	2273	DISSIPATORE	5	3024	PROFILI SPECIALI	119
2072	DISSIPATORE	7	2274	DISSIPATORE	54	3026/N	PROFILI SPECIALI	114
2072D46	DISSIPATORE	7	2276	PROFILI FOTOVOLTAICO	99	3027/N	PROFILI SPECIALI	114
2073	DISSIPATORE	9	2277	PROFILI SPECIALI	115	3028	PROFILI SPECIALI	114
2073D70	DISSIPATORE	8	2278	DISSIPATORE	6	3029	PROFILI SPECIALI	108
2074	DISSIPATORE	7	2279	PROFILI SPECIALI	130	3030	PROFILI SPECIALI	108
2074D46	DISSIPATORE	7	2298	DISSIPATORE	5	3031	PROFILI SPECIALI	108
2075	DISSIPATORE	7	2300	PROFILI PNEUMATICA	90	3032	PROFILI SPECIALI	108
2076	DISSIPATORE	11	2318	PROFILI SPECIALI	117	3033	PROFILI SPECIALI	108
2077	PROFILI SPECIALI	113	2320	PROFILI SPECIALI	117	3034	PROFILI SPECIALI	108
2091	CONTENITORE ELETTRONICA	1	2321	PROFILI SPECIALI	117	3035	PROFILI SPECIALI	119
2096	PROFILI SPECIALI	130	2322	PROFILI SPECIALI	117	3036	PROFILI SPECIALI	113
2097	DISSIPATORE	59	2323	PROFILI SPECIALI	117	3037	PROFILI SPECIALI	113
2098	DISSIPATORE	56	2324	PROFILI SPECIALI	117	3043	PROFILI SPECIALI	118
2100	DISSIPATORE	5	2325	PROFILI SPECIALI	118	3044	PROFILI SPECIALI	117
2101	DISSIPATORE	62	2326	PROFILI SPECIALI	117	3045	PROFILI SPECIALI	118
2111	PROFILI SPECIALI	130	2327	PROFILI SPECIALI	117	3048	PROFILI SPECIALI	114
2112	DISSIPATORE	8	2328	PROFILI SPECIALI	117	3050	PROFILI SPECIALI	114
2113	PROFILI RACLE	120	2329	PROFILI SPECIALI	117	3051	PROFILI SPECIALI	110
2115	DISSIPATORE	11	2331	PROFILI SPECIALI	117	3052	PROFILI SPECIALI	110
2116	DISSIPATORE	59	2332	PROFILI SPECIALI	117	3053	PROFILI SPECIALI	110
2119	DISSIPATORE	6	2333	PROFILI SPECIALI	117	3054	PROFILI SPECIALI	110
2120	PROFILI SPECIALI	121	2334	PROFILI SPECIALI	117	3055	PROFILI SPECIALI	110
2126	CONTENITORE ELETTRONICA	2	2335	PROFILI SPECIALI	117	3056	PROFILI SPECIALI	110
2127	PROFILI SPECIALI	130	2336	PROFILI SPECIALI	117	3057	PROFILI SPECIALI	110
2129	DISSIPATORE	6	2338	PROFILI SPECIALI	117	3058	PROFILI SPECIALI	110
2131	CONTENITORE ELETTRONICA	3	2339	PROFILI SPECIALI	117	3059	PROFILI SPECIALI	110
2134	DISSIPATORE	7	2340	PROFILI SPECIALI	117	3060	PROFILI SPECIALI	110
2136	PROFILI SPECIALI	108	2341	PROFILI SPECIALI	117	3061	PROFILI SPECIALI	110
2139	DISSIPATORE	5	2342	PROFILI SPECIALI	118	3062	PROFILI SPECIALI	110
2142	DISSIPATORE	5	2343	PROFILI SPECIALI	118	3063	PROFILI SPECIALI	110
2144	DISSIPATORE	5	2344	PROFILI SPECIALI	117	3064	PROFILI SPECIALI	113
2148	DISSIPATORE	11	2345	PROFILI SPECIALI	117	3065	PROFILI SPECIALI	110
2153	DISSIPATORE	12	2346	PROFILI SPECIALI	117	3066	PROFILI SPECIALI	110
2154	CONTENITORE ELETTRONICA	3	2347	PROFILI SPECIALI	117	3067	PROFILI SPECIALI	113
2155	DISSIPATORE	23	2348	PROFILI SPECIALI	117	3068	PROFILI SPECIALI	110
2156	CONTENITORE ELETTRONICA	2	2349	PROFILI SPECIALI	117	3069	PROFILI SPECIALI	113
2158	DISSIPATORE	7	2350	PROFILI SPECIALI	117	3070	PROFILI SPECIALI	113
2160	PROFILI SPECIALI	114	2351	PROFILI SPECIALI	117	3071	PROFILI SPECIALI	113
2161	PROFILI SPECIALI	111	2352	PROFILI SPECIALI	117	3072	PROFILI SPECIALI	110
2163	PROFILI RACLE	121	2353	PROFILI SPECIALI	117	3073	PROFILI SPECIALI	110
2165	PROFILI SPECIALI	111	2354	PROFILI SPECIALI	119	3074	PROFILI SPECIALI	110
2170	DISSIPATORE	12	2355	PROFILI SPECIALI	119	3075	PROFILI SPECIALI	110
2176	DISSIPATORE	8	2356	PROFILI SPECIALI	119	3076	PROFILI SPECIALI	110
2181	DISSIPATORE	7	2357	PROFILI SPECIALI	117	3077	PROFILI SPECIALI	111
2183	PROFILI SPECIALI	111	2358	PROFILI SPECIALI	117	3078	PROFILI SPECIALI	111
2187	CONTENITORE ELETTRONICA	2	2448	CONTENITORE ELETTRONICA	1	3079	PROFILI SPECIALI	111
2193	DISSIPATORE	10	2496	CONTENITORE ELETTRONICA	1	3080	PROFILI SPECIALI	111
2196	DISSIPATORE	4	3000	PROFILI STAND	64	3081/N	PROFILI SPECIALI	111
2197	DISSIPATORE	9	3001	PROFILI SPECIALI	117	3082/N	PROFILI SPECIALI	109
2198	DISSIPATORE	5	3002	PROFILI SPECIALI	108	3083	PROFILI SPECIALI	125
2200	PROFILI SPECIALI	119	3003	PROFILI SPECIALI	117	3084	PROFILI SPECIALI	125
2202	DISSIPATORE	6	3004	PROFILI SPECIALI	117	3085	PROFILI SPECIALI	125
2203	DISSIPATORE	52	3004-1	PROFILI SPECIALI	117	3086	PROFILI SPECIALI	125
2210	DISSIPATORE	52	3005	PROFILI SPECIALI	113	3087	PROFILI SPECIALI	125
2212	PROFILI COM PONIBILI	70	3006	PROFILI SPECIALI	119	3088	PROFILI SPECIALI	125
2216	DISSIPATORE	5	3007	PROFILI SPECIALI	119	3089	PROFILI SPECIALI	125
2219	DISSIPATORE	4	3008	PROFILI SPECIALI	119	3090	PROFILI SPECIALI	125
2227	DISSIPATORE	60	3010	PROFILI SPECIALI	113	3091	PROFILI SPECIALI	125
2228	DISSIPATORE	109	3011	PROFILI SPECIALI	113	3092	PROFILI SPECIALI	125
2230	PROFILI SPECIALI	113	3012	PROFILI SPECIALI	113	3093	PROFILI SPECIALI	125
2232	CONTENITORE ELETTRONICA	1	3013	PROFILI SPECIALI	113	3097	DISSIPATORE	5
2235	DISSIPATORE	11	3014	PROFILI SPECIALI	113	3098	PROFILI SPECIALI	108
2243	PROFILI COM PONIBILI	66	3015	PROFILI SPECIALI	113	3099	PROFILI SPECIALI	108
2248	DISSIPATORE	4	3016	PROFILI SPECIALI	118	3100	PROFILI SPECIALI	109
2249	DISSIPATORE	22	3017	PROFILI SPECIALI	119	3101	PROFILI SPECIALI	108
2254	DISSIPATORE	60	3018	PROFILI SPECIALI	116	3102	PROFILI SPECIALI	108
2258	PROFILI SPECIALI	124	3019	PROFILI SPECIALI	111	3103	PROFILI SPECIALI	109

Consultate il Catalogo aggiornato Online
all'indirizzo www.omar-alluminio.it

Indice Articoli

3104	PROFILI SPECIALI	108	3180	PROFILI SPECIALI	111	3263	PROFILI SPECIALI	110
3105	PROFILI SPECIALI	108	3181	PROFILI SPECIALI	111	3264	PROFILI SPECIALI	110
3106	PROFILI SPECIALI	108	3182	PROFILI SPECIALI	113	3265	PROFILI SPECIALI	113
3107	PROFILI SPECIALI	108	3184	PROFILI SPECIALI	113	3266	PROFILI SPECIALI	110
3108	PROFILI SPECIALI	108	3185	PROFILI SPECIALI	108	3267	PROFILI SPECIALI	110
3109	PROFILI SPECIALI	108	3187	PROFILI SPECIALI	119	3269	PROFILI SPECIALI	110
3110	PROFILI SPECIALI	109	3188	PROFILI SPECIALI	108	3270	PROFILI SPECIALI	117
3111	PROFILI SPECIALI	109	3189/N	PROFILI SPECIALI	111	3271	PROFILI RACLE	125
3112	PROFILI SPECIALI	108	3190	PROFILI SPECIALI	118	3272	PROFILI RACLE	125
3113	PROFILI SPECIALI	108	3191	PROFILI SPECIALI	111	3307	PROFILI SPECIALI	113
3114	PROFILI SPECIALI	108	3192	PROFILI SPECIALI	118	3308	PROFILI SPECIALI	125
3115	PROFILI SPECIALI	109	3193	PROFILI SPECIALI	111	3309	PROFILI SPECIALI	125
3116	PROFILI SPECIALI	109	3194	PROFILI SPECIALI	111	3310	PROFILI SPECIALI	109
3117	PROFILI SPECIALI	130	3195	PROFILI SPECIALI	111	3311	PROFILI SPECIALI	115
3118	PROFILI SPECIALI	109	3197	PROFILI SPECIALI	111	3312	PROFILI SPECIALI	115
3119	PROFILI SPECIALI	109	3199	PROFILI SPECIALI	111	3313	PROFILI SPECIALI	115
3120	PROFILI SPECIALI	109	3200	PROFILI SPECIALI	126	3314	PROFILI SPECIALI	120
3121	PROFILI SPECIALI	109	3201	PROFILI SPECIALI	126	3315	PROFILI SPECIALI	115
3122	PROFILI SPECIALI	109	3202	PROFILI SPECIALI	109	3316	PROFILI SPECIALI	115
3123	PROFILI SPECIALI	109	3203	PROFILI SPECIALI	114	3317	PROFILI SPECIALI	115
3124/N	PROFILI SPECIALI	109	3204	PROFILI SPECIALI	114	3318	PROFILI SPECIALI	116
3125	PROFILI SPECIALI	111	3205	PROFILI SPECIALI	114	3319	PROFILI SPECIALI	118
3126	PROFILI SPECIALI	109	3209	PROFILI SPECIALI	114	3320	PROFILI SPECIALI	118
3127	PROFILI SPECIALI	130	3210	PROFILI SPECIALI	114	3321	PROFILI SPECIALI	118
3128	PROFILI SPECIALI	109	3211	PROFILI SPECIALI	114	3322	PROFILI SPECIALI	118
3129/N	PROFILI SPECIALI	111	3212	PROFILI SPECIALI	114	3323	PROFILI SPECIALI	118
3130	PROFILI SPECIALI	109	3213	PROFILI SPECIALI	114	3324	PROFILI SPECIALI	118
3131	PROFILI SPECIALI	109	3214	PROFILI SPECIALI	114	3325	PROFILI SPECIALI	118
3132	PROFILI SPECIALI	111	3215	PROFILI SPECIALI	108	3326	PROFILI SPECIALI	118
3133	PROFILI SPECIALI	113	3216	PROFILI SPECIALI	111	3327	PROFILI SPECIALI	110
3134	PROFILI SPECIALI	113	3217	PROFILI SPECIALI	109	3328	PROFILI SPECIALI	110
3135	PROFILI SPECIALI	113	3218	PROFILI SPECIALI	108	3329	PROFILI SPECIALI	110
3137	PROFILI SPECIALI	111	3219	PROFILI SPECIALI	108	3330	PROFILI SPECIALI	110
3138	PROFILI SPECIALI	111	3220	PROFILI SPECIALI	109	3332	PROFILI SPECIALI	110
3140	PROFILI SPECIALI	113	3221	PROFILI SPECIALI	107	3333	PROFILI SPECIALI	111
3141/N	PROFILI SPECIALI	108	3222	PROFILI SPECIALI	107	3334	PROFILI SPECIALI	118
3142	PROFILI SPECIALI	119	3223	PROFILI SPECIALI	107	3335	PROFILI SPECIALI	117
3143	PROFILI SPECIALI	108	3224	PROFILI SPECIALI	107	3336	PROFILI SPECIALI	116
3144	PROFILI SPECIALI	108	3225	PROFILI SPECIALI	107	3337	PROFILI SPECIALI	111
3145	PROFILI SPECIALI	119	3226	PROFILI SPECIALI	108	3338	PROFILI SPECIALI	111
3146	PROFILI SPECIALI	119	3227	PROFILI SPECIALI	119	3339	PROFILI SPECIALI	115
3147	PROFILI SPECIALI	124	3229	PROFILI SPECIALI	130	3340	PROFILI SPECIALI	116
3148	PROFILI SPECIALI	114	3230	PROFILI SPECIALI	108	3341	TENDE PER INTERNI	128
3149	PROFILI SPECIALI	114	3231	PROFILI SPECIALI	113	3342	TENDE PER INTERNI	128
3150	PROFILI SPECIALI	114	3232	PROFILI SPECIALI	111	3343	TENDE PER INTERNI	128
3151	PROFILI SPECIALI	114	3234	PROFILI SPECIALI	125	3344	TENDE PER INTERNI	128
3152	PROFILI SPECIALI	109	3235	PROFILI SPECIALI	125	3345	TENDE PER INTERNI	128
3153	PROFILI SPECIALI	111	3236	PROFILI SPECIALI	125	3346	TENDE PER INTERNI	128
3154	PROFILI SPECIALI	111	3237	PROFILI SPECIALI	108	3347	TENDE PER INTERNI	128
3155	PROFILI SPECIALI	111	3238	PROFILI SPECIALI	108	3348	TENDE PER INTERNI	128
3156	PROFILI SPECIALI	107	3239	PROFILI SPECIALI	111	3349	TENDE PER INTERNI	128
3159	PROFILI SPECIALI	124	3240	PROFILI SPECIALI	110	3350	TENDE PER INTERNI	128
3160	PROFILI SPECIALI	114	3241	PROFILI SPECIALI	110	3351	TENDE PER INTERNI	129
3161	PROFILI SPECIALI	114	3242	PROFILI SPECIALI	110	3354	TENDE PER INTERNI	129
3162	PROFILI SPECIALI	107	3243	PROFILI SPECIALI	110	3355	TENDE PER INTERNI	129
3163	PROFILI SPECIALI	111	3245	PROFILI SPECIALI	110	3356	TENDE PER INTERNI	129
3164	PROFILI SPECIALI	109	3246	PROFILI SPECIALI	110	3357	TENDE PER INTERNI	129
3165	PROFILI SPECIALI	111	3247	PROFILI SPECIALI	110	3358	TENDE PER INTERNI	129
3166	PROFILI SPECIALI	111	3248	PROFILI SPECIALI	110	3359	TENDE PER INTERNI	129
3167	PROFILI SPECIALI	114	3249	PROFILI SPECIALI	110	3672	CONTENITORE ELETTRONICA	1
3168	PROFILI SPECIALI	109	3250	PROFILI SPECIALI	110	3696	CONTENITORE ELETTRONICA	1
3169	PROFILI SPECIALI	111	3251	PROFILI SPECIALI	117	4848	CONTENITORE ELETTRONICA	1
3170	PROFILI SPECIALI	110	3252	PROFILI SPECIALI	110	4896	CONTENITORE ELETTRONICA	1
3171	PROFILI SPECIALI	108	3253	PROFILI SPECIALI	110	7272	CONTENITORE ELETTRONICA	1
3172	PROFILI SPECIALI	114	3254	PROFILI SPECIALI	118	9696	CONTENITORE ELETTRONICA	1
3173	PROFILI SPECIALI	109	3256	PROFILI SPECIALI	118	36144	CONTENITORE ELETTRONICA	1
3174	PROFILI SPECIALI	111	3257	PROFILI SPECIALI	110	48192	CONTENITORE ELETTRONICA	2
3175	PROFILI SPECIALI	111	3259	PROFILI SPECIALI	110	50144	CONTENITORE ELETTRONICA	1
3177	PROFILI SPECIALI	108	3260	PROFILI SPECIALI	110	72144	CONTENITORE ELETTRONICA	1
3178	PROFILI SPECIALI	109	3261	PROFILI SPECIALI	110	96192	CONTENITORE ELETTRONICA	2
3179	PROFILI SPECIALI	109	3262	PROFILI SPECIALI	110	PNC100	PROFILI PNEUMATICI	87

Via Newton, n.12
20016 Pero (Milano - Italy)
Tel. +39 02 3535955 r.a. Fax. +39 02 3539929
E-Mail: info@omar-alluminio.it

Cataloghi Online: www.omar-alluminio.it
www.omar-alluminio.com
PROFILATI ALLUMINIO A DISEGNO / STANDARD / SPECIALI / E PER:
ELETTRONICA / LED / FOTOVOLTAICO / AUTOMAZIONE ROBOTICA / PNEUMATICA / AUTOMOTIVE



Via Newton, n. 12
20016 Pero (Milano - Italy)
Tel. +39 02 3535955 r.a. Fax. +39 02 3539929
E. Mail: info@omar-alluminio.it

Cataloghi Online: www.omar-alluminio.it
www.omar-alluminio.com
PROFILATI ALLUMINIO A DISEGNO / STANDARD / SPECIALI / E PER:
ELETTRONICA / LED / FOTOVOLTAICO / AUTOMAZIONE ROBOTICA / PNEUMATICA / AUTOMOTIVE



Indice Articoli

Consultate il Catalogo aggiornato Online
all'indirizzo www.omar-alluminio.it

PNC25	PROFILI PNEUMATICI	87	PNT2024	PROFILI PNEUMATICI	86			
PNC32	PROFILI PNEUMATICI	87	PNT2025	PROFILI PNEUMATICI	86			
PNC40	PROFILI PNEUMATICI	87	PNT2529	PROFILI PNEUMATICI	86			
PNC50	PROFILI PNEUMATICI	87	PNT2530	PROFILI PNEUMATICI	86			
PNC63	PROFILI PNEUMATICI	87	PNT3236	PROFILI PNEUMATICI	86			
PNC80	PROFILI PNEUMATICI	87	PNT3238	PROFILI PNEUMATICI	86			
PNCT100	PROFILI PNEUMATICI	88	PNT3540	PROFILI PNEUMATICI	86			
PNCT25	PROFILI PNEUMATICI	88	PNT3640	PROFILI PNEUMATICI	86			
PNCT32	PROFILI PNEUMATICI	88	PNT4044	PROFILI PNEUMATICI	86			
PNCT40	PROFILI PNEUMATICI	88	PNT4045	PROFILI PNEUMATICI	86			
PNCT50	PROFILI PNEUMATICI	88	PNT5054	PROFILI PNEUMATICI	86			
PNCT63	PROFILI PNEUMATICI	88	PNT5055	PROFILI PNEUMATICI	86			
PNCT80	PROFILI PNEUMATICI	88	PNT5057	PROFILI PNEUMATICI	86			
PNLG100	PROFILI PNEUMATICI	89	PNT5060	PROFILI PNEUMATICI	86			
PNLG125	PROFILI PNEUMATICI	89	PNT5560	PROFILI PNEUMATICI	86			
PNLG32	PROFILI PNEUMATICI	89	PNT5660	PROFILI PNEUMATICI	86			
PNLG40	PROFILI PNEUMATICI	89	PNT6065	PROFILI PNEUMATICI	86			
PNLG50	PROFILI PNEUMATICI	89	PNT6367	PROFILI PNEUMATICI	86			
PNLG63	PROFILI PNEUMATICI	89	PNT6368	PROFILI PNEUMATICI	86			
PNLG80	PROFILI PNEUMATICI	89	PNT6570	PROFILI PNEUMATICI	86			
PNM80100	PROFILI PNEUMATICI	79	PNT7075	PROFILI PNEUMATICI	86			
PNM80125	PROFILI PNEUMATICI	79	PNT7580	PROFILI PNEUMATICI	86			
PNM8020	PROFILI PNEUMATICI	79	PNT8085	PROFILI PNEUMATICI	86			
PNM8025	PROFILI PNEUMATICI	79	PNT8086	PROFILI PNEUMATICI	86			
PNM8032	PROFILI PNEUMATICI	79	PNT8590	PROFILI PNEUMATICI	86			
PNM8040	PROFILI PNEUMATICI	79	PNT9095	PROFILI PNEUMATICI	86			
PNM8050	PROFILI PNEUMATICI	79	PNT9097	PROFILI PNEUMATICI	86			
PNM8063	PROFILI PNEUMATICI	79	PNT95100	PROFILI PNEUMATICI	86			
PNM8080	PROFILI PNEUMATICI	79	PR30X3,6X1,8	TENDE PER INTERNI	128			
PNM89100	PROFILI PNEUMATICI	82	PR40X3X1,5	TENDE PER INTERNI	128			
PNM89125	PROFILI PNEUMATICI	82	PR40X3,6X1,8	TENDE PER INTERNI	128			
PNM89160	PROFILI PNEUMATICI	83	TR200X20/S	PROFILI SPECIALI	112			
PNM89200	PROFILI PNEUMATICI	83	TR200X25/S	PROFILI SPECIALI	112			
PNM8932	PROFILI PNEUMATICI	81	TR200X50/S	PROFILI SPECIALI	112			
PNM8940	PROFILI PNEUMATICI	81	TR200X70/S	PROFILI SPECIALI	112			
PNM8950	PROFILI PNEUMATICI	81	TR270X40/S	PROFILI SPECIALI	112			
PNM8963	PROFILI PNEUMATICI	81	TR300X50/S	PROFILI SPECIALI	112			
PNM8980	PROFILI PNEUMATICI	81	TR330X35/S	PROFILI SPECIALI	112			
PNM90100	PROFILI PNEUMATICI	80						
PNM9032	PROFILI PNEUMATICI	80						
PNM9040	PROFILI PNEUMATICI	80						
PNM9050	PROFILI PNEUMATICI	80						
PNM9063	PROFILI PNEUMATICI	80						
PNM9080	PROFILI PNEUMATICI	80						
PNP94100	PROFILI PNEUMATICI	85						
PNP9416	PROFILI PNEUMATICI	85						
PNP9420	PROFILI PNEUMATICI	85						
PNP9425	PROFILI PNEUMATICI	85						
PNP9432	PROFILI PNEUMATICI	85						
PNP9440	PROFILI PNEUMATICI	85						
PNP9450	PROFILI PNEUMATICI	85						
PNP9463	PROFILI PNEUMATICI	85						
PNP9480	PROFILI PNEUMATICI	85						
PNR99100	PROFILI PNEUMATICI	84						
PNR99125	PROFILI PNEUMATICI	84						
PNR9932	PROFILI PNEUMATICI	84						
PNR9940	PROFILI PNEUMATICI	84						
PNR9950	PROFILI PNEUMATICI	84						
PNR9963	PROFILI PNEUMATICI	84						
PNR9980	PROFILI PNEUMATICI	84						
PNT100106	PROFILI PNEUMATICI	86						
PNT100107	PROFILI PNEUMATICI	86						
PNT105110	PROFILI PNEUMATICI	86						
PNT1216	PROFILI PNEUMATICI	86						
PNT125131	PROFILI PNEUMATICI	86						
PNT125132	PROFILI PNEUMATICI	86						
PNT150160	PROFILI PNEUMATICI	86						
PNT160167	PROFILI PNEUMATICI	86						
PNT160170	PROFILI PNEUMATICI	86						
PNT1620	PROFILI PNEUMATICI	86						
PNT200210	PROFILI PNEUMATICI	86						

Tipo di matrici di estrusione

Extrusion tools

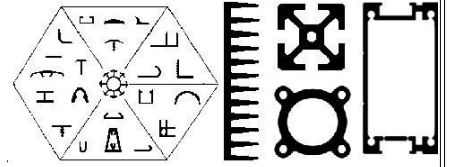

A) matrice piana per
profilato aperto

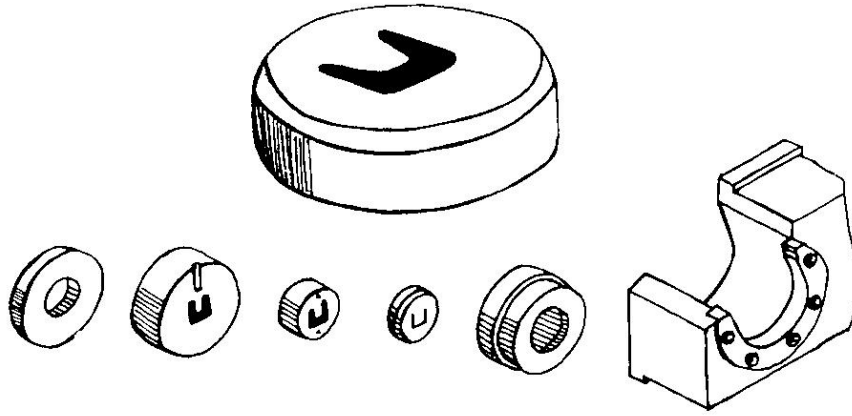

B) matrice Spyder per
profilato cavo

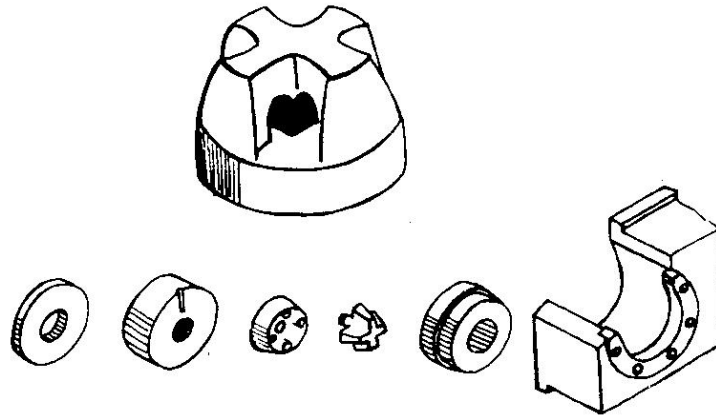

C) matrice Porthole
per profilato cavo

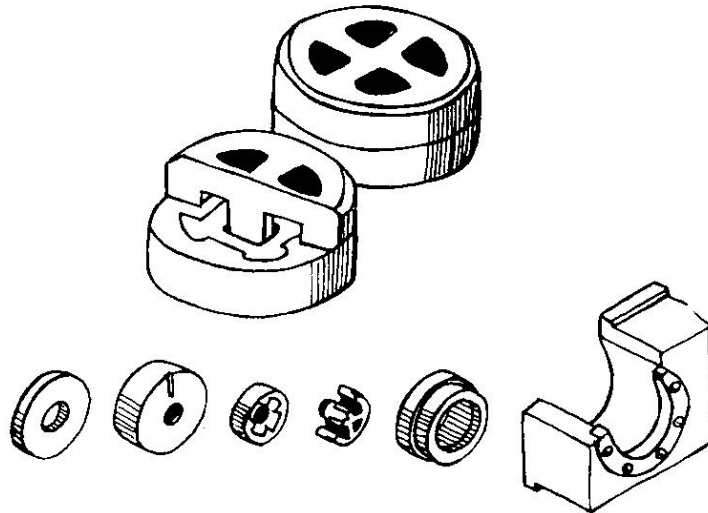

D) matrice a Ponte simile
a Porthole per profilato cavo

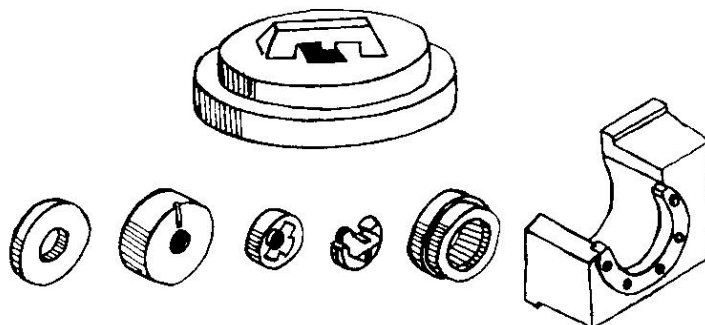

Via Newton, n.12
20016 Pero (Milano - Italy)
Tel. +39 02 3535955 r.a. Fax. +39 02 3539929
E-Mail: info@omar-alluminio.it

Cataloghi Online: www.omar-alluminio.it
www.omar-alluminio.com

PROFILATI ALLUMINIO A DISEGNO / STANDARD / SPECIALI / E PER:
ELETTRONICA / LED / FOTOVOLTAICO / AUTOMAZIONE ROBOTICA / PNEUMATICA / AUTOMOTIVE



- DIMENSIONI MASSIME ESTRUDIBILI -

SCALA 1:3

470

330

R145

R90

PRESSA 3200 TON

PRESSA 6050 TON

450

630

Cataloghi Online: www.omar-alluminio.it
www.omar-alluminio.com

Via Newton, n.12

20016 Pero (Milano - Italy)

Tel. +39 02 3535955 r.a. Fax. +39 02 3539929

E.Mail: info@omar-alluminio.it

PROFILATI ALLUMINIO A DISEGNO / STANDARD / SPECIALI / E PER:

ELETTRONICA / LED / FOTOVOLTAICO / AUTOMAZIONE ROBOTICA / PNEUMATICA / AUTOMOTIVE

OMAR s.r.l.
PROFILATI ALLUMINIO
ALTA TECNOLOGIA

Principali leghe da estrusione

Extrusion aluminium alloy properties

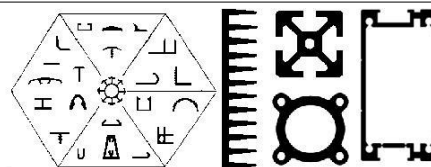

LEGA DI ALLUMINIO DA ESTRUSIONE EN AW-6060

La lega EN AW 6060 è lega da estrusione più diffusa sul mercato europeo, per le sue doti di alta velocità di deformazione a caldo.

Essa consente la realizzazione di profilati con sezione anche complessa, comprendente cavità e scanalature, per avvicinare quanto più possibile il disegno dell'estruso a quello del manufatto finito, e ridurre al minimo le lavorazioni intermedie.

Essa inoltre presenta ottima resistenza alla corrosione ambientale, anche in atmosfera industriale e marina.

Caratteristiche fisiche

Massa volumica	2,70	Gr/cm3	Conducibilità termica a 20°C	Nello stato 0: 2,09 W/cm °Kelvin Nello stato T6: 1,75 W/cm °Kelvin
Punto di fusione inferiore	605	C	Coeff. Di dilatazione termica lineare	Tra 20° e 100°C: 23,0 -10-6 1°/Kelvin Tra 20° e 200°C: 24,0 -10-6 1°/Kelvin Tra 20° e 300°C: 25,0 -10-6 1°/Kelvin
Calore specifico tra 0° e 100°C	890	Joule/Kg °Kelvin	Resistività elettrica a 20°C	Nello stato 0: 3,14 microOhm *cm Nello stato T6: 3,25 microOhm *cm
Modulo di elasticità lineare E	69000	Newton/mm2		
Modulo di elasticità tangenziale G	26000	Newton/mm2		

Tipo profilo	(1) stato fisico di fornitura	Diametro D		Carico	Di rottura σ	Carico di	Rottura σ	Allungamento	
		o spess. S	[mm] per tonde,					Trazione	Rm [Mpa]
		o spess. Di parete	e per barre,	min	max	min	max	min	max
tondi e barre piane	T4 (*)	D ≤150	S ≤150	120	-	60	-	16	14
	T5	D ≤150	S ≤150	160	-	120	-	8	6
	T6 (*)	D ≤150	S ≤150	190	-	150	-	8	6
	T64 (*)	D ≤50	S ≤50	180	-	120	-	12	10
	T66 (*)	D ≤150	S ≤150	215	-	160	-	8	6
tubi	T4(*)	e ≤15		120	-	60	-	16	14
	T5	e ≤15		160	-	120	-	8	6
	T6(*)	e ≤15		190	-	150	-	8	6
	T64(*)	e ≤15		180	-	120	-	12	10
	T66(*)	e ≤15		215	-	160	-	8	6
Profili aperti e cavi	T4 (*)	e ≤25		120	-	60	-	16	14
	T5	e ≤5		160	-	120	-	8	6
		5 < e ≤ 25		140	-	100	-	8	6
	T6 (*)	e ≤3		190	-	150	-	8	6
		3 < e ≤ 25		170	-	140	-	8	6
	T64 (*)	e ≤15		180	-	120	-	12	10
	T66 (*)	e ≤3		215	-	160	-	8	6
3 < e ≤ 25			195	-	150	-	8	6	

LEGA	Stato fisico	Deformabilità plastica		Lavorabilità su macchina utensile	Saldabilità	Lucidabilità	Ossidazione	anodica		Resistenza alla corrosione		
		a freddo	a caldo					protettiva	decorativa	urbana	industriale	marina
EN AW-3103	F,H 112	2	1	5	3	4	3	3	1	1	2	
	O,H 111	2	1	5	3	4	3	3	1	1	2	
EN AW-6060	O	2	1	5	2	4	1	2	1	2	2	
	T1,T4	3	2	4	2	3	1	1	1	2	2	
	T5,T6	4	X	3	2	2	1	1	1	2	2	
EN AW-6063	O,H 111	2	1	5	2	4	1	2	2	2	3	
	T4	3	2	4	2	3	1	1	2	2	3	
	T5,T6	4	X	3	2	2	1	1	2	2	3	
EN AW-6005A	O	2	1	4	2	3	2	4	2	3	3	
	T4	3	2	3	2	2	2	3	2	3	3	
	T5,T6	4	X	2	2	1	2	3	2	3	3	
EN AW-6082	O,H 111	2	1	4	2	3	2	3	3	3	3	
	T4	3	2	3	2	2	2	2	3	3	3	
	T5,T6	4	X	2	2	1	2	2	3	3	3	

INDICE DI VALUTAZIONE: 1=OTTIMO 2=BUONO 3=SUFFICIENTE 4=MEDIOCRE 5=SCARSO X=NON APPLICABILE AGLI STATI T5 E T6

Via Newton, n.12
20016 Pero (Milano - Italy)
Tel. +39 02 3535955 r.a. Fax. +39 02 3539929
E-Mail: info@omar-alluminio.it

Cataloghi Online: www.omar-alluminio.it
www.omar-alluminio.com

PROFILATI ALLUMINIO A DISEGNO / STANDARD / SPECIALI / E PER:
ELETTRONICA / LED / FOTOVOLTAICO / AUTOMAZIONE ROBOTICA / PNEUMATICA / AUTOMOTIVE



FIERA MILANO RHO - PERO



Via Newton, n.12
20016 Pero (Milano - Italy)
Tel.+39 02 3535955 r.a.
Fax.+39 02 3539929
E.Mail: info@omar-alluminio.it

Consultate il ns. catalogo aggiornato online all'indirizzo:

www.omar-alluminio.it
www.omar-alluminio.com
www.omar-alluminio.eu

PROFILATI IN ALLUMINIO
A DISEGNO-STANDARD-SPECIALI



E PER: ELETTRONICA-LED-FOTOVOLTAICO
AUTOMAZIONE ROBOTICA-PNEUMATICA-AUTOMOTIVE